

Fuel Bioethanol Production from Whey Permeate

THÈSE N° 4372 (2009)

PRÉSENTÉE LE 24 AVRIL 2009

À LA FACULTÉ SCIENCES DE BASE
LABORATOIRE DE BIOTECHNOLOGIE ENVIRONNEMENTALE
PROGRAMME DOCTORAL EN CHIMIE ET GÉNIE CHIMIQUE

ÉCOLE POLYTECHNIQUE FÉDÉRALE DE LAUSANNE

POUR L'OBTENTION DU GRADE DE DOCTEUR ÈS SCIENCES

PAR

François-Nicolas de GLUTZ

acceptée sur proposition du jury:

Prof. V. Hatzimanikatis, président du jury
Prof. C. Holliger, Prof. I. W. Marison, directeurs de thèse
Prof. C. Lacroix, rapporteur
Dr C. Poget, rapporteur
Prof. U. von Stockar, rapporteur



ÉCOLE POLYTECHNIQUE
FÉDÉRALE DE LAUSANNE

Suisse
2009

*” Tout grand progrès
scientifique est né d'une
nouvelle audace de
l'imagination.”*

[John Dewey]

Remerciements

Par ces quelques lignes je souhaiterais remercier toutes les personnes qui ont fait de ces quatre dernières années passées à l'EPFL des moments inoubliables. Arrivé au terme de ce travail je tiens à remercier sincèrement toutes les personnes qui y ont contribué.

Ma reconnaissance va tout d'abord au Professeur Ian Marison pour ses conseils, sa confiance, sa bonne humeur et son positivisme à toute épreuve qui m'ont aidé à garder le cap tout au long de cette thèse. Je tiens également à remercier particulièrement le Professeur Christof Holliger qui m'a accueilli dans son laboratoire durant cette dernière année de doctorat et qui a toujours pris le temps de m'écouter et me conseiller dans cette période cruciale. J'aimerais témoigner ma reconnaissance au Professeur Urs von Stockar qui, déjà antérieurement, m'a transmis sa passion pour le génie chimique et m'a intégré au Laboratoire de Génie Chimique et Biologique où j'ai passé trois années magnifiques.

Je suis extrêmement reconnaissant à Monsieur Pierre Schaller, directeur d'Alcosuisse, qui, par sa participation au projet, a rendu ce travail possible ainsi qu'à Pierre Krummenacher pour toute la coordination des meetings et son suivi scientifique.

J'aimerais également remercier tout l'équipe du LGCB et en particulier Véro, Agnès et Voja pour les conseils, l'ambiance et afterwork party que nous avons partagé avec tout le « ground zero ». Il en va de même pour le team du LBE où la bonne ambiance a régné tout au long de cette année et tout spécialement Aurélie. Merci à Laure, Julien, Cyrille, Noam, David, Pierre et tous les autres.

Merci également à Evelyne Toubes et Sonja Desplos qui m'ont grandement facilité toutes les démarches administratives et étaient toujours de bonne humeur. Je n'oublierai pas Jacky Gremaud et Marie Jirousek du magasin qui sont toujours disponibles et de bonne humeur, PAP, notre informaticien, les mécaniciens et électroniciens ainsi que Christophe Roussel.

Finalement j'aimerais remercier ma famille pour leur intérêt et leur soutien durant ce travail ainsi que tout au long de mes études. Un merci tout particulier à Magalí qui a eu beaucoup de patience et qui a réussi à me redonner de la force dans les moments de doutes.

Table of Contents

Abstract	vi
Résumé	viii
Chapter 1: Introduction	
1. History of fermentation	2
2. Whey, a cheese production by-product	3
3. Whey and whey permeate	5
4. Motivation	6
5. Biofuels and Bioethanol	8
6. Objectives and Strategy of the thesis	11
7. Structure of the thesis	13
8. Nomenclature	14
9. References	15
Chapter 2: Process design and economic evaluation for ethanol production from cheese whey	
1. Abstract	20
2. Introduction	21
3. Materials and Methods	22
4. Results and Discussion	24
4.1 Production pathways	24
4.2 Centralized direct fermentation of concentrated whey permeate (scenario I)	28
4.3 Centralized indirect fermentation of concentrated whey permeate (scenario J) .	34
5. Conclusions	38
6. Nomenclature	40
7. References	41
Chapter 3: Stabilization of whey permeate to enable ethanol production by <i>Kluyveromyces marxianus</i>	
1. Abstract	44
2. Introduction	45
3. Materials and Methods	47
3.1 Microorganisms, inocula preparation, media and preservative agents	47

3.2	Culture conditions	48
3.3	Reagents and metabolite analysis.....	48
3.4	Hydrogen peroxide titration	49
4.	Results and Discussion.....	50
4.1	Screening of methods for whey permeate preservation	50
4.2	Stabilization of whey permeate using formic acid and hydrogen peroxide	52
4.3	Ethanol production	55
5.	Conclusions	57
6.	Nomenclature	58
7.	Acknowledgments	58
8.	References	59

Chapter 4: Enhancement of ethanol productivity by controlling pre-culture conditions

1.	Abstract	62
2.	Introduction	63
2.1	Design of experiment methodology	64
3.	Materials and Methods	68
3.1	Microorganisms and culture conditions	68
3.2	Analytical methods and pre-culture media.....	68
4.	Results and discussion.....	69
4.1	Experimental parameters.....	69
4.2	Lag phase.....	71
4.3	Specific growth rate	74
4.4	Pre-culture biomass	76
4.5	General discussion.....	77
5.	Conclusions	79
6.	Nomenclature	80
7.	References	81

Chapter 5: Ethanol fermentation of whey and hydrolyzed whey permeate: yeast strain selection and performance optimization

1.	Abstract	84
2.	Introduction	85
2.1	Microbial Growth Kinetics.....	86

2.2	Ethanol fermentation	88
3.	Materials and Methods	92
3.1	Yeast strains and inocula	92
3.2	Fermentation media	92
3.3	Culture conditions	93
3.4	Reagents and metabolite analysis	93
4.	Results	93
4.1	Indirect whey fermenting yeasts	95
4.2	Direct whey fermenting yeasts	97
5.	Discussion	100
5.1	Indirect whey fermenting yeasts	100
5.2	Direct whey fermenting yeasts	103
6.	Conclusions	106
7.	Nomenclature	107
8.	References	108

Chapter 6: Mixed-culture fermentation of non-sterile whey permeate

1.	Abstract	114
2.	Introduction	115
3.	Materials and Methods	116
3.1	Microorganisms, inocula preparation and media	116
3.2	Culture conditions	117
3.3	Reagents and metabolite analysis	117
4.	Results and Discussion	118
4.1	Identification of strains present in a whey-fermenting mixed-culture	118
4.2	Characterization of whey fermentation by mixed-culture	121
4.3	Whey fermentation by pure cultures of the mixed-culture isolates	125
4.4	Fermentation of non-sterilized whey permeate by a reconstituted consortium of <i>K. marxianus</i> and <i>E. faecalis</i>	128
5.	Conclusions	129
6.	Nomenclature	130
7.	References	131

Chapter 7: *In-situ* product recovery of ethanol by an organic-aqueous two-phase extraction system

1. Abstract	138
2. Introduction	139
2.1 Solvent toxicity	140
2.2 Encapsulation for decreasing solvent toxicity	141
2.3 Choice of polymer	141
2.4 Properties of alginate	143
3. Materials and Methods	145
3.1 Microorganisms, inocula preparation and media	145
3.2 Reagents, biomass and metabolite analysis	146
3.3 Measurement of the ethanol partition coefficient	146
3.4 Biocompatibility measurements	147
3.5 Capsule production	147
3.6 Batch cultures	147
4. Results and Discussion	148
4.1 Selection of a solvent	148
4.2 Capsule characterization	152
4.3 Batch cultures	155
5. Conclusions	158
6. Nomenclature	159
7. References	160

Chapter 8: General Conclusions and Perspectives

1. General Conclusions	164
1.1 Substrate stabilization	164
1.2 Optimal batch strategy for the production of ethanol	165
1.3 Advantage of mixed cultures	168
1.4 Novel ISPR system for liquid-liquid extraction	169
2. Perspectives	171
3. References	173

Curriculum vitae

Summary

Abstract & Résumé

1. **Abstract**

The objective of this thesis was to evaluate the feasibility for the production of fuel bioethanol from whey permeate. The identification of the limiting factors of the process revealed that the stabilization of the substrate was critical to the use of whey as a fermentation substrate and that the conversion yields and ethanol tolerance limited the process.

A comparison of the possible scenarios for the production of bioethanol from whey was first performed. It was demonstrated that fresh whey should be concentrated at the production site before being transported to a centralized treatment plant, since transporting dilute material or producing ethanol at the dairy would result in too high operating costs. An economic comparison of a treatment plant, which (i) “directly” ferments lactose into ethanol using *Kluyveromyces fragilis* and (ii) “indirectly” ferments hydrolyzed whey using *Saccharomyces cerevisiae*, resulted in similar production costs of 1.35 CHF/L_{EtOH} and 1.32 CHF/L_{EtOH} respectively.

Whey stabilization was investigated by testing the addition of chemical compounds to whey. These were evaluated according to their ability to prevent the growth of lactic acid bacteria which were identified as being mainly responsible for whey instability. Formic acid (50 mM) or hydrogen peroxide (100 mM) were shown to extend the stability from 2-3 days, at 4°C to 21 days at ambient temperature. However, such concentrations of preservative also inhibit the growth of yeasts, therefore they must be removed prior to fermentation. Of the compounds tested, formic acid was preferred due to the high level of bacterial growth inhibition at pH 4, and its non-toxicity for yeast at neutral pH. This would enable whey to be stored at room temperature for a three-week period without negatively influencing the subsequent yeast fermentation.

Global productivity of the initial fermentation cultures was considerably reduced as a result of a long non-productive lag phase. In order to improve the understanding of the principle factors which, not only influence the duration of the lag phase, but also the biomass produced during a pre-culture period of 24h and the maximum growth rate in fermentation cultures, six pre-culture parameters were tested alone or in combination on two ethanol-producing yeasts, *K. marxianus* CBS 5795 and CBS 397, using whey permeate as substrate through the application of design of experiment procedures. The key parameters identified through this strategy were: influence of temperature, type of sugar, culture mode, initial biomass concentration and initial sugar concentration. Optimum ethanol productivity was achieved by cultivating the pre-culture anaerobically on medium containing lactose, which resulted in an

improvement of the productivity by 10-11% compared to an aerobic pre-culture with glucose. The principal organism studied for ethanol fermentation from whey permeate was *K. fragilis* due to its ability to directly ferment lactose. However, such direct fermentation yeasts generally suffer from low conversion yields and poor tolerance to ethanol (2-3% v/v). An alternative is to utilize indirect fermentation yeasts, such as *S. cerevisiae*, which show considerably better ethanol fermentation performance but has the disadvantage that an expensive enzymatic hydrolysis step is required prior to fermentation. In this study both types of process have been characterized involving eight ethanol producing yeasts. The culture conditions were optimized for each strain using a design of experiment methodology. Highest conversion yield and alcohol tolerance were achieved with *S. cerevisiae* Ethanol Red ($Y_{P/S} = 0.662$ C-mol/C-mol, $c_{EtOHmax} = 148$ g/L), of the indirect fermentation yeasts, and with *K. marxianus* CBS 5795 ($Y_{P/S} = 0.660$ C-mol/C-mol, $c_{EtOHmax} = 79$ g/L) of the direct fermentation yeasts studied. Introducing the data obtained from cultures with these yeasts to former economic evaluations of both scenarios, showed that direct fermentation should be preferred for fermenting whey permeate to ethanol. A maximum volumetric productivity of 6.24 g/(L·h) at 37°C and pH 4 was achieved with *K. marxianus* CBS 5795.

Fermentation of non-sterile whey permeate with a consortium (CEKI) of *K. marxianus* (S1), *I. orientalis* (S2) and *E. faecalis* (S3), isolated from spontaneous cultures, was then studied. Maximal ethanol yield of 0.65 C-mol/C-mol, as highest ethanol concentration of 55 g/L, was achieved with CEKI, at 37°C and pH 4, compared to isolated cultures of these organisms. The results also suggest that *E. faecalis* exhibits a protective effect against lactic acid bacteria. Specific productivity of CEKI was 0.21 g_{EtOH}/(g_{biomass}·h).

Finally, a novel *in-situ* product recovery method, based on capsular perstraction with an organic solvent, was developed for ethanol extraction in batch fermentation systems using CEKI, which utilizes microcapsules. The production of capsules of 2 mm diameter that contained a hydrophobic core of laurinaldehyde and an alginate-based membrane enabled (i) to reduce the toxicity of the solvent for the growing cultures, and (ii) make the separation of the organic phase easier for a subsequent ethanol recovery. For the produced capsules mass transfer was determined by the solvent layer ($0.27 \cdot 10^{-5}$ cm²/s), which resulted in a maximum specific ethanol recovery of 3.17 g_{EtOH}/(g_{solvent}·s).

Keywords: *Kluyveromyces marxianus*, *Saccharomyces cerevisiae*, ethanol, whey permeate, economical analysis, preservation, fermentation, productivity, mixed-culture, liquid-liquid extraction, encapsulation, alginate.

2. Résumé

L'objectif de cette thèse était de définir la faisabilité de la production de bioéthanol carburant à partir de petit-lait. L'identification des facteurs limitant du procédé a relevé qu'il fallait principalement répondre aux problèmes de stabilisation du substrat, ainsi qu'améliorer les rendements et la concentration d'alcool lors de l'étape de fermentation.

Une évaluation des scénarios possibles a d'abord été effectuée. Pour des raisons de coûts de transport et d'énergie, il a été montré que le petit-lait devait tout d'abord être concentré sur site avant d'être acheminé vers un centre de traitement centralisé. Une analyse économique, portant sur (i) la fermentation directe du petit-lait, par *Kluyveromyces fragilis* et (ii) indirecte d'un petit-lait hydrolysé, à l'aide de *Saccharomyces cerevisiae*, a révélé que ces deux stratégies aboutissaient à des coûts de production similaire, de respectivement 1.35 CHF/L_{EtOH} et 1.32 CHF/L_{EtOH}.

Sept composés chimiques ont été testés afin de définir leurs capacités à prévenir la prolifération des bactéries responsables de l'instabilité du petit-lait. Une concentration de 50 mM d'acide formique ou de 100 mM de peroxyde d'hydrogène a permis de passer d'une période de conservation de 2-3 jours, réfrigéré à 4°C, à une durée de 21 jours, stocké à température ambiante. De telles concentrations sont cependant également toxiques pour les levures utilisées pour la fermentation et il a fallu neutraliser l'agent conservateur avant fermentation. De ces deux agents conservateurs l'acide formique a finalement été préféré pour sa spécificité à limiter la croissance bactérienne à pH 4 et sa non-toxicité à pH neutre, permettant, par simple du pH, de préserver et ensuite fermenter aussi efficacement un petit-lait contenant, ou pas, l'agent conservateur.

De ces premières cultures il est ressorti que la productivité globale de l'étape de fermentation était considérablement limitée par une longue période de latence. L'influence de six facteurs de pré-culture a été évaluée sur la durée de cette période de latence, mais aussi, sur la biomasse produite après 24h de pré-culture et le taux de croissance lors de la fermentation: la température, l'aération, le type et de la quantité de sucre disponible ainsi que la concentration initiale de biomasse. Ces facteurs ont été testés sur deux levures *K. marxianus* CBS 5795 and CBS 397. Le type de sucre et le mode de culture ont le plus influencé ces paramètres, permettant, par une pré-culture en anaérobiose sur lactose, d'améliorer la productivité globale de 10-11% comparé à une pré-culture en aérobiose sur glucose. Le principal organisme étudié pour la fermentation du perméat de petit-lait est *K. fragilis* car cette levure est capable d'assimiler directement le lactose. Pourtant une telle levure présente un taux de conversion

généralement faible et ne tolère des concentrations en éthanol que de l'ordre de 2-3% v/v. Une alternative consiste à utiliser une levure de type *S. cerevisiae* qui a un rendement supérieur et tolère de plus grandes teneurs d'alcool, mais nécessite une étape d'hydrolyse supplémentaire afin de convertir le lactose, non assimilable par cet organisme, en glucose et galactose. Les paramètres de culture de huit levures ont été optimisés et comparés en mode batch afin de caractériser la production d'éthanol par ces deux voies. Les meilleurs rendements et tolérances en éthanol ont été mesurés avec *S. cerevisiae* Ethanol Red ($Y_{P/S}$ = 0.662 C-mol/C-mol, $c_{EtOHmax}$ = 148 g/L), parmi les levures dites "indirectes", et avec *K. marxianus* CBS 5795 ($Y_{P/S}$ = 0.660 C-mol/C-mol, $c_{EtOHmax}$ = 79 g/L), d'entre les levures dites "directes". L'introduction de ces valeurs aux modèles économiques préalablement établis a permis de conclure que la fermentation directe était la stratégie la plus adaptée à la fermentation du perméat de petit-lait en éthanol. Une productivité volumique spécifique maximal de 6.24 g/(L·h) a été obtenue avec *K. marxianus* CBS 5795 à 37°C et pH 4.

La fermentation d'un perméat de petit-lait non stérile par un consortium composé de *Kluyveromyces marxianus*, *Issatchenkia orientalis* and *Enterococcus faecalis* (CEKI), isolés de cultures spontanées, a ensuite été étudiée. Un rendement maximal de 0.65 C-mol/C-mol ainsi qu'une concentration maximale d'éthanol de 55 g/L ont été obtenus avec CEKI, à 37°C et pH 4, comparé à des cultures effectuées dans les mêmes conditions avec ces organismes isolés. La présence d'*E. faecalis* semble être déterminante pour observer un effet protectif contre la prolifération de bactéries lactiques dans le perméat non stérile. La productivité spécifique de CEKI est 0.21 $g_{EtOH}/(g_{biomass}\cdot h)$.

Finalement une nouvelle méthode, basée sur la perstraction d'éthanol à l'aide d'un solvant organique encapsulée, a été développée afin de récupérer en continu l'alcool produit par une culture de CEKI sur perméat de petit-lait. La production de capsules de 2 mm de diamètre contenant un cœur hydrophobe de laurinaldéhyde et une membrane à base d'alginate a permis de (i) limiter l'effet toxique du solvant sur CEKI, comparé à un système d'extraction par contact direct, et (ii) séparer de manière plus aisée les deux phases en vue de la récupération du produit. Il a été montré que le transfert de l'éthanol dans les capsules était limité par le solvant ($0.27\cdot 10^{-5}$ cm²/s) permettant à un tel système d'extraire jusqu'à 3.17 $g_{EtOH}/(g_{solvent}\cdot s)$.

Mots-clés : *Kluyveromyces marxianus*, *Saccharomyces cerevisiae*, éthanol, perméat de petit-lait, analyse économique, conservation, fermentation, productivité, culture mixte, extraction liquide-liquide, encapsulation, alginate.

Chapter 1

Introduction

1. *History of fermentation*

In broad terms, fermentation is an enzyme-catalyzed transformation of organic matter by the action of micro-organisms. Many civilizations have been performing fermentation for thousands of years with wine-making thought to have been practiced since 10'000 BC. Historians found papers showing that the Egyptians produced beer in 6000 BC. Two thousand years later a new application was found for brewer's yeast for the production of carbon dioxide in the leavening of bread. The origin and variety of indigenous fermented foods of the Orient, now known to be based on fermentation, goes back thousands of years with the first transformations, by fermentation, of milk into products such as cheese dating back to 5000 BC. Vinegar has probably been produced for as long as wine-making. Earliest manuscripts relating the distillation of potable spirits date back to 1000 BC in China [1].

Transformation of foods by fermentation has therefore been carried out for at least 10'000 years before Man recognized the existence of micro-organisms. Huge improvements in fermentation processes have been made since their early beginnings [2]. Humanity had to wait until 1690 for the discovery of yeast cells, when Leeuwenhoek, examined drops of fermented beer with a primitive microscope. This first observation did not have an important impact at that time but the idea of living materials involved in fermentation processes grew in the mind of scientists such as Cagniard-Latour, Schwann, Wohler or Blondeau. It is finally Louis Pasteur who described, in 1856 after detailed investigations on beer and wine fermentation, the first mechanism of fermentation concluding that living yeast cells ferment sugar into ethanol and carbon dioxide when they are growing in the absence of air [3].

2. *Whey, a cheese production by-product*

In 2006, Switzerland produced almost 4000 million liters of milk, which was used as depicted in Figure 1. Of this production, over one third is dedicated to the production of cheese, resulting in the generation of very large quantities of whey.

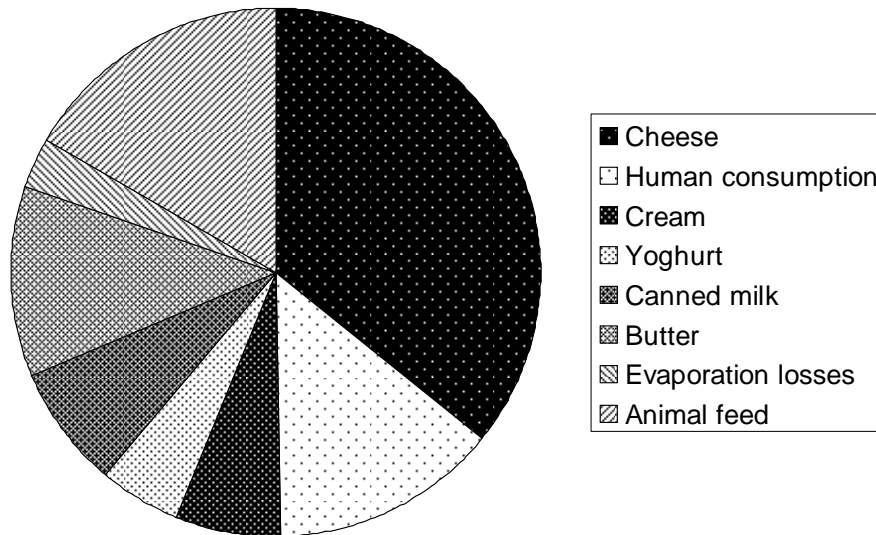

Figure 1. Common use of milk in Switzerland [4].

While almost half of the whey is returned to the farmers who use it as animal feed, whey can be dried and used as sport dietary supplements, fermented by lactic bacteria to produce light yoghurts, concentrated for syrups, flocculated into ricotta cheese or transformed into beverages such as Rivella (Figure 2) [5-7]. Finally whey can be fermented by specific microorganisms to produce biogas or ethanol, products which can be used as renewable energy sources, e.g. as biofuels for cars.

Brazil is by far the most advanced country with respect to bioethanol production, since bioethanol represents 22% of all the fuels, which is to say 40% of combustion fuels, used in this country and 337'000 people are involved in its exploitation [8]. This advance is the consequence of the desire to reduce dependence on imported fossil fuels through the utilization of an internal agricultural product allowing the control of the sugar currency. The first petrol crisis in 1973/74 was the initial stimulus for mass production of bioethanol in Brazil which was reinforced by the second petrol crisis in 1979. This was facilitated by the large amounts of sugar cane, which was already a natural widely available resource [9].

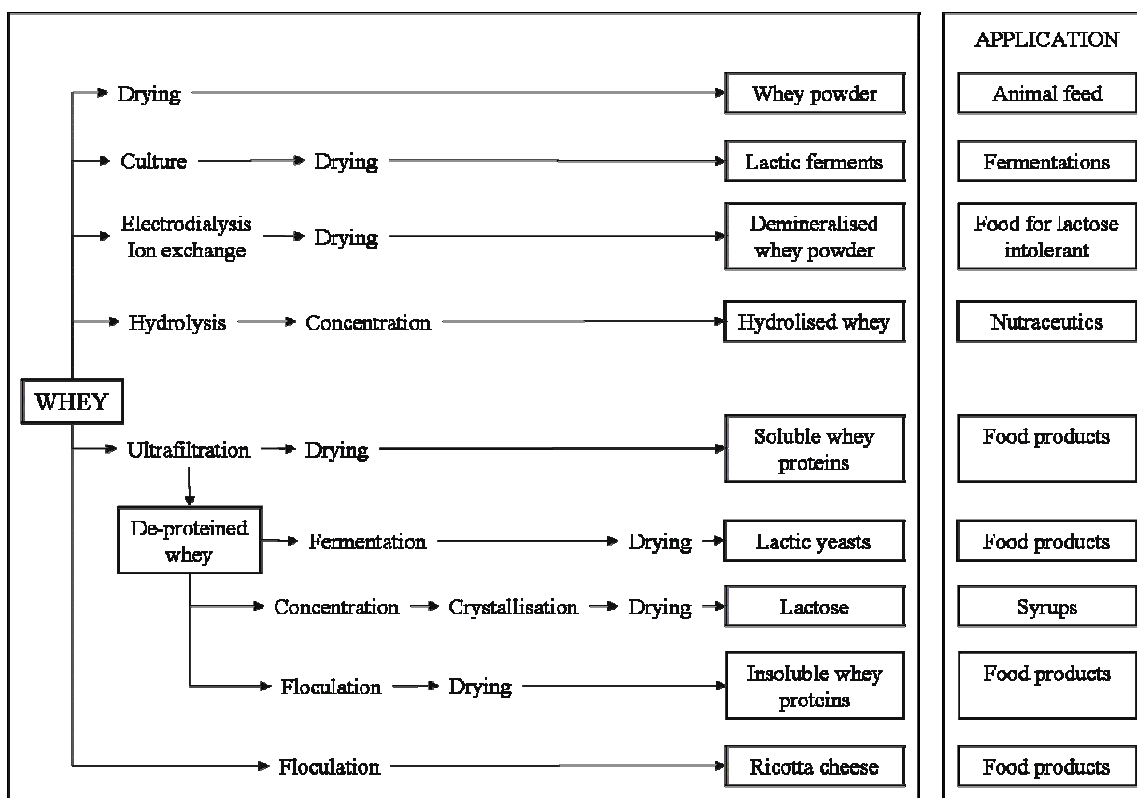

Figure 2. Valorization possibilities of whey.

Because of the high price of oil, the national Proálcool program began at the end of 1975 to provide substitute energy sources [10]. The Brazilian government encouraged the production of ethanol and cars working only with ethanol, resulting in a stimulus to the production of anhydrous ethanol. While Brazil mostly uses sugarcane as raw material for the production of ethanol, other countries have explored the use of whey for the production of ethanol. New Zealand and Ireland are, as Switzerland characterized by an important cheese production and thus large quantities of whey to valorize. However there is an important difference between Switzerland and these countries. While Ireland and New Zealand have centralized State companies for the milk industry and thus can build fermentation plants in the neighborhood of the milk treatment centers [11], Switzerland has more than 1500 producers of various sizes all over the country. The transport costs considerably increase the global production cost of ethanol resulting in a real challenge to find an economic method to produce biofuels from whey.

3. *Whey and whey permeate*

Cheese whey is the liquid that remains after milk has been curdled and strained during the cheese making process. This by-product of cheese production represents about 85-95% of the milk volume and retains 55% of milk nutrients. Whey does not have a standard composition (Table 1) as it depends on the type of cheese and the quality of milk from which it is obtained. But, broadly speaking it is possible to affirm that it is made up of about 95% water and 5% dry matter (DM), of which about 10% is protein, 70% is lactose and the rest mineral salts, vitamins, lactic acid and other trace elements [12]. Depending on the procedure used for casein precipitation, whey can be classified as acidic whey ($\text{pH} < 5$) or sweet whey ($6 < \text{pH} < 7$). In addition to the pH, the two types of whey also differ in that acidic whey usually has lower protein concentration and sweet whey has a higher lactose concentration [13].

Table 1. Typical composition of whey [12].

Compound	[g/kg]
Albumin	4.98
Peptides	0.83
Lipids	0.41
Lactose	38.1
Lactic acid	0.08
Citric acid	1.66
Monovalent cationic salts	1.66
Polyvalent cationic salts	1.01
Monovalent ammonium salts	0.92
Polyvalent ammonium salts	0.99
Total	50.64 (5.06% DM)

Due to the low concentration of solid constituents (5% DM), whey has commonly been considered as a waste product in spite of the high nutritional potential it holds. Due to the high organic matter content of whey, the 5-day Biochemical Oxygen Demand (BOD_5) ranges from 35,000 to 60,000 mg/l [14-15], which represents an important environmental problem [16]. Since large quantities of whey are produced (9 kg of whey are produced in the production of 1 kg of cheese) [13], there is increasing concern as to how this can be efficiently and cost-effectively eliminated without adversely affecting the environment.

Proteins from whey have a high nutritional value that can be exploited. This exploitation usually involves separation of the proteins from the whey by ultrafiltration (UF), the resultant product being termed whey permeate. This method of separation possesses the main advantage in that it does not denature proteins, so that they conserve their original nutritional value. Whey permeate resulting from UF has about 4% DM content. Another possibility is to subject UF treated whey to Reverse Osmosis (RO), in which case the dry matter concentration in whey will increase to approximately 12%. Whey permeate has the same BOD₅ level compared to whole whey and thus poses a comparable disposal problem. Most cheese makers see whey as a nuisance, mainly because of the high volume produced (the total amount of liquid cheese whey produced world-wide is estimated to be 10⁸ tonnes/year) [17] and the high cost of its disposal. Traditionally, cheese whey has been used to feed animals, but while it may help to reduce the waste load of a dairy farm it does not take real economical advantage of the product. For this reason it became indispensable to look for alternative uses in order to add value to this cheese by-product. This is fundamental to the Swiss case where most of the cheese producing units are not large enough to treat their own production of whey themselves in order to obtain a product with a higher added value. Most cheese factories in Switzerland are dispersed throughout the country and it would be necessary to transport the whey from several factories to one big transformation plant. The problem here, however, is the chemical and biological instability of whey and whey products [18] resulting in difficulties and high costs in transport and storage.

4. Motivation

Through the ratification of the United Nations Framework Convention on Climate Change of Rio elaborated in 1992, Switzerland has engaged to stabilize “Humanity's emissions of greenhouse gases” at a level that would prevent dangerous perturbations of the climatic system. This engagement was reinforced by the signature of the United Nations Kyoto Protocol in March 1998 and by the introduction of a principle of sustainable development in the Federal Constitution in 1999. With the exception of CO₂, pollutant emissions due to fossil fuel consumption for the combustion engine are in constant diminution as the result of the introduction of the catalytic converter, antipollution norms EURO 2 followed by EURO 3 and finally unleaded petrol. Consequently current, non-CO₂ emission levels of the fifties or sixties have been achieved [19] CO₂ emissions from vehicles however, continuously increase (from 1990 and 2000: +9% for private vehicles and +17% for trucks) to reach currently more than 30% of all greenhouse gas

emissions [20]. An effort in the direction of reduction of greenhouse gas emissions, in particular in the field of road transport is essential in order to reduce the risk of natural disasters due to heating of the planet and to fulfill the engagements taken by Switzerland (Kyoto Protocol). Thus a global reduction of greenhouse gas emissions of 10% compared to 1990 is required until 2008/2012 together with 8% in the fossil fuel field.

Since the consumption of fossil fuels has steadily increased from 1990 until today, the deviation from the target levels for CO₂ emissions is approximately 15%, or 2- 2,5 million tonnes of CO₂. For this reason bioethanol production has shown growing interest as a possible means to reduce greenhouse gas emissions [21]. Either pure, transformed to ETBE, or mixed with petrol or gasoline, bioethanol is considered as a fuel in a growing number of countries. A mixture of bioethanol with petrol in a ratio of 5% v/v does not require any modification of the vehicle engines, while added to gasoline to 10% v/v requires only minor modification to the distribution chain [21].

Producing ethanol from intensive agriculture would not be possible in Switzerland due to the high costs of production. For this reason, this project aims to focus on waste or untreated products from a range of industries. Companies such as Booregaard have produced bioethanol from lignocellulosic matter resulting from cellulose manufacture in Solothurn, however the production cannot satisfy national demand for ethanol. Whey is an interesting candidate because Switzerland disposes of large quantities and there are many limitations and problems resulting in such a high production of whey [22-23]. While most of whey is used for animal feed, the quantity is limited due to the lactose intolerance of cattle and pigs.

Furthermore, due to the very low dry matter concentration of whey and the resulting large volumes required, the redistribution of whey to farmers is very expensive. Schingoethe [24] published the maximum usable quantities of whey in the feed of poultry, pigs, rats and ruminants. From this work, and more recent work done, particularly in France, it is evident that adult ruminants are able to use much larger quantities of whey than other species. In the rumen, lactose is broken down quite rapidly by bacteria and protozoa and converted into lactic acid, which is metabolized into volatile fatty acids, principally butyric acid. Under normal feeding conditions very little lactic acid is absorbed into the blood, but if the animals are given large quantities of lactose before the microbial population of the rumen has become adjusted to its use, severe fermentation problems may result. Lactic acid in excess penetrates the wall of the rumen and may

cause serious metabolic disorders (acidosis). For this reason there is still a large amount of whey which cannot be used as animal, and even human, feed/ food [25]. Due to the strict legislative requirements for the provision of water contamination in Switzerland, whey has to be neutralized in wastewater treatment plants. The cost for wastewater treatment in Switzerland is very high, with an investment of approximately $15 \cdot 10^3$ CHF per kilo BOD₅ per day [26], which corresponds to 7.5 million CHF for the daily treatment of 100 tonnes of whey. For this reason it is easy to understand that it is neither economically nor environmentally feasible to dispose of excess whey by such methods. The requirement of whey disposal has stimulated the development of new uses for whey [14, 27].

The development of methods for the production of biofuels (bioethanol) is considered renewable and sustainable. A bioethanol fuel lowers the CO₂ emissions proportional to the incorporated quantity. It also maintains and allows the development of the agricultural activities and, from an economical point of view, a reduction of the importation of foreign fuel products. Discussions with companies proposing bioethanol production units (Maguin Interis, France) showed that, while some technological areas, such as distillation, are well understood others, such as fermentation, require significant development and improvement. Bioethanol production processes have been performed for a long time. The first applications of bioethanol for cars date back to the beginning of car conception, with bioethanol produced by fermentation of sugar beet. Henry Ford created the Model T Ford, which functioned with pure ethanol [21]. Forty years ago the fossil fuel market developed worldwide and interest in bioethanol decreased until in 1973, due to the petroleum crisis, new possibilities were once again opened to bioethanol. Nowadays the world production of bioethanol is estimated at more than 16 million tonnes per year [8]. Such important economical stakes have stimulated the search for improvements to the fermentation processes.

5. *Biofuels and Bioethanol*

Biofuels can generally be defined as solid, liquid or gas fuels derived from recent biological materials, and are thus distinguished from fossil fuels, which are derived from fossilized biological material. Nowadays, the most widely produced biofuels are ethanol, diesel and methane (biogas) [28].

Biogas is produced by the process of anaerobic digestion of organic material by anaerobic microorganisms and is particularly well adapted to heating [29] or electricity production at the production site. If compressed, it can replace compressed natural gas for use in vehicles, where it can feed an internal combustion engine or fuel cells and is a much more effective displacer of carbon dioxide than the normal use in on site plants.

Biodiesel is the most common biofuel in Europe and is increasingly being used in the USA [30, 31]. It is produced from oils or fats using a trans-esterification step for obtaining a fuel of similar composition to fossil diesel. Biodiesel is used, in pure form or blended with fossil diesel, in modern cars or aircraft engines without any modifications [32].

Bioethanol is the most common biofuel worldwide [33, 34] and particularly in Brazil where it represents almost 40% of overall traffic fuel. Alcohol fuels are produced by fermentation of sugars derived from wheat, corn, sugar beet, sugar cane, molasses, whey, grass, wood crops, potatoes, etc... Bioethanol production consists in, a pretreatment step, often an enzyme digestion, in order to release simple sugars from polysaccharides to make them more easily assimilated and fermented by microorganisms, followed by distillation and drying.

More recently, additional biofuels such as methanol, propanol, butanol and ethers are playing a more and more important role in fuel cells applications [28] and are thus competitors to ethanol, natural gas or hydrogen. Biodiesel from vegetable oil reduces greenhouse emissions by around 40-55 percent and ethanol from corn, which is mostly produced in the United States, generally reduces the emissions by less than 30 percent [35]. When produced from liquid manures biogas can even reduce by 80 percent overall CO₂ emissions [28]. Made of grain, oilseeds and sugar, the so-called "green" fuels are expected to lower dependence on fossil fuels, cut carbon dioxide emissions, one of the main causes for climate change, and raise farm revenues. But many observers have pointed to their fast development to explain the rise in farm prices, notably for wheat, corn and soybeans whose prices surged in the past year, leading to higher food prices and raising inflationary concerns. An EMPA study released in 2008 also stressed that the cure may be worse than the disease, saying doubts remained whether biofuels could still be considered "green" when all elements, including the energy and pesticides used to produce feedstock, are included in the balance [28].

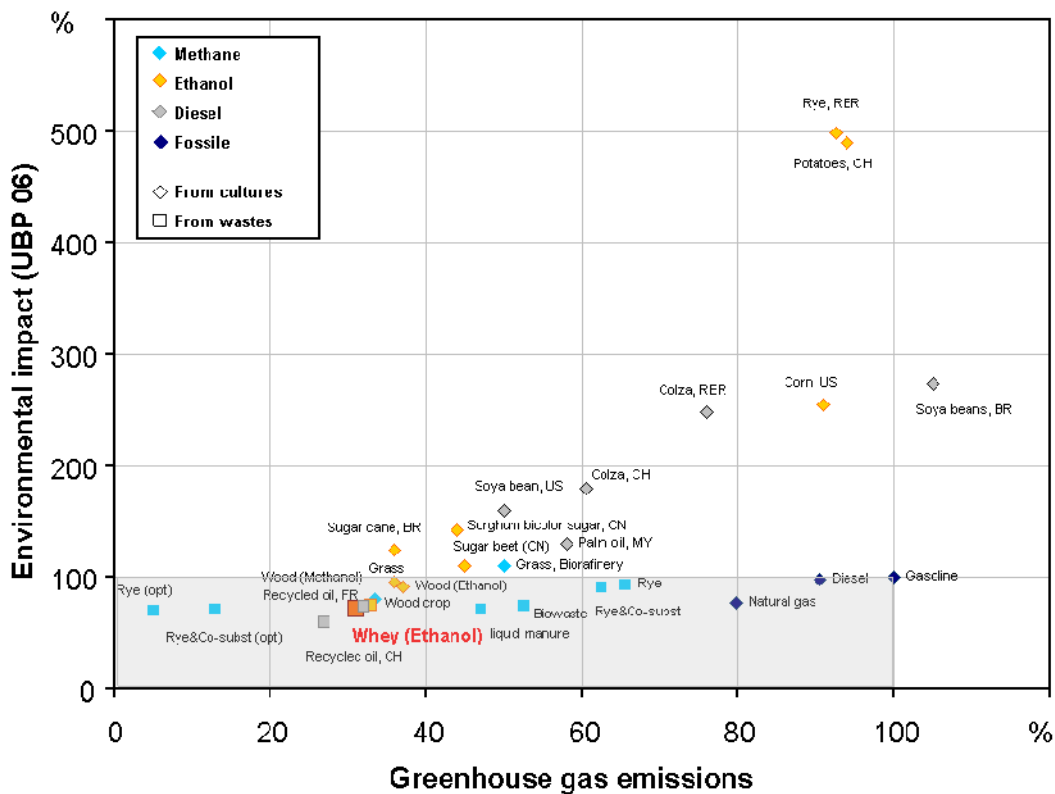

Figure 3. Two dimension representation of greenhouse gas emissions and overall environmental impact modeled with UBP 06 methodology [28]. Comparison is given to gasoline used as reference. Grey area shows the domain in which lower emissions and land damages compared to gasoline are achieved.

Figure 3 presents overall greenhouse emissions reduction of biomethane, biodiesel and bioethanol compared to recycled gasoline when they are produced from different feedstock and show their relative impact on the environment. The impact on environment considers not only the use of soil pollutants (pesticides and herbicides), fertilizers (nitrates and phosphates) and heavy metals, but also takes into account the extensive exploitation of the soils and the impact on human health. It can be clearly seen that, if greenhouse gas reduction alone is considered, all considered biofuels, with the exception of biodiesel produced from soya beans in Britain, permit a global reduction of the emissions.

However, only biofuels derived from waste/by-products show lower environmental effects. This is the case for methane derived from liquid manure, biomass and wood, biodiesel from recycled oils and bioethanol from whey, wood crops and grass. When produced from whey, bioethanol presents the most important reduction of greenhouse gas emissions and the lowest environmental impact. By comparison when fermenting corn, or worse, potatoes and rye only

slight reduction of greenhouse gases is achieved but three to five time larger land damage results from this ethanol production. As a result, waste products should be used to produce biofuels in order to achieve an overall positive environmental impact since whey disposal represents a real problem for the cheese industry, bioethanol production offers an ideal alternative to its valorization.

6. Objectives and Strategy of the thesis

This project aims to determine the optimal method of bioethanol production from whey in Switzerland, or countries with similar production context. The first part of the project will be, based on the early research performed in the field of ethanol production from whey, to determine the actual cost of a production plant and to define the limitations of the existing knowledge. This work will then focus on the areas identified as offering the biggest improvement potential.

While molasses and cereals are relatively stable and therefore easy to transport and store near the bioethanol production site, the same cannot be said for more biodegradable feedstock such as whey [36]. Even after the use of reverse osmosis and evaporation to concentrate the whey from approximately 5% solids to 25-26% solids, whey has a shelf life of less than 3 days when stored at 4°C. Thus a major limitation to the successful commercial production of bioethanol will be to solve the problem of raw feedstock stability and storage [8]. This may be overcome either by direct fermentation in small plants close to the production sites or by enzymatic hydrolysis of the lactose in whey to glucose and galactose, followed by reverse osmosis and evaporation to around 60-70% solids, a condition under which the sugar syrup is stable for many months at ambient temperatures with negligible loss of quality. Such processes would be undertaken directly at the production sites. As a result there would be less material to transport to the bioethanol production site and no specialized form of transport would be required (no refrigeration). This would require use of commercially available enzymes (β -galactosidase) [37].

Some yeasts are capable of directly fermenting lactose in whey to bioethanol. However, the number of strains is limited and they are generally very sensitive to product inhibition (ethanol) at concentrations as low as 2% [38, 39]. Many yeasts are capable of fermenting hydrolyzed lactose, thus it would be possible to use higher ethanol concentrations (>10-15% ethanol). In the best case, after concentration and hydrolysis of whey followed by a further concentration (to 60-70% solids) and transport to the bioethanol production site, fermentation

would be undertaken followed by distillation and dehydration to 99.7% alcohol after yeast separation. However, a major problem is the low concentration of ethanol formed (2-5% for sugars such as lactose) due to ethanol inhibition [40]. Consequently the energy costs required for distillation from these dilute solutions to 99.7% are very high. Indeed it has been estimated that increasing the ethanol concentration in the fermentation to >10% would result in a 3-4 fold decrease in distillation energy costs [41]. This might be overcome by several approaches.

The first approach will involve the use of ethanol tolerant yeasts, while the second will involve the application of *in situ* product recovery techniques (ISPR) in order to continuously remove the ethanol as it is formed [36], thereby preventing an inhibitory concentration accumulating in the bioreactor. This problem will be facilitated by the fact that either a single yeast strain, or mixture of yeasts, would be used for whey or hydrolyzed whey. If the raw materials were used directly as feedstock for the fermentation, rather than being hydrolyzed to soluble sugars [42], then bioethanol production would require a different organism for each raw material, since no yeast exists which naturally produces invertases (necessary for sucrose-based feedstock), amylases (starch) [43], amyloglucosidases (starch) [7], cellulases (lignocellulose), cellobiohydrolases (lignocellulose), β -galactosidases (lactose) and the enzymes [44] necessary for pentose sugar fermentation (lignocellulose) [37]. However, certain *Saccharomyces cerevisiae* strains are commercially available which are reported to withstand over 15% ethanol, and be capable of fermenting most of the hexose sugars resulting from raw material hydrolysis. An important part of this work will be to obtain a range of commercial alcohol tolerant yeasts and to determine the growth and production kinetics on hydrolyzed whey or glucose over a pre-decided range of concentrations and conditions, to compare these properties and to determine which would be most suitable for direct fermentation in multi-substrate bioethanol process. Thus it will be important to show if a preferential feedstock utilization is observed (first consumption of glucose), diauxic effects, feedstock accumulation (e.g. galactose accumulation due to slower consumption rate kinetics) or catabolite repression.

In parallel to the use of alcohol tolerant yeasts a second study will involve the application of *in situ* product recovery techniques to continuously remove the alcohol as it is formed to maintain a non-inhibitory concentration in the bioreactor. One method involves the use of liquid-core microcapsules, in which an organic phase (oil) is surrounded by a hydrogel membrane. Since the microcapsules are less dense than water, they may be readily recovered by flotation. This is a totally novel application of microcapsules.

7. Structure of the thesis

This thesis is structured in seven chapters: an introduction, six chapters presenting experimental results and one chapter of general conclusions and perspectives.

Chapter 1 introduces the topic of bioethanol fermentation presenting historical introduction, goals and specific characteristics of bioethanol production from whey and whey permeate. **Chapter 2** presents an economic computer-modeled ethanol production process of direct and indirect whey fermentation. This part puts into evidence the critical operations of a global production process and thus permitted to focus on critical operating steps. **Chapter 3** is devoted to substrate conservation. A preservation strategy which allows efficient whey / whey permeate stabilization over a three-week period for subsequent ethanol fermentation with *K. marxianus* was successfully developed. **Chapter 4** focuses on better understanding the influence of culture and pre-culture parameters on ethanol productivity with *K. marxianus*, mainly by controlling the lag phase. **Chapter 5** compares ethanol performance of direct and indirect fermentation of eight yeast strains in order to compare which way of doing ensured higher ethanol productivity from whey permeate. **Chapter 6** presents batch fermentations of non-sterile whey permeate by using a mixed culture isolated from spontaneous fermenting whey, containing two yeasts and one bacterium. **Chapter 7** introduces *in-situ* ethanol recovery by using liquid-liquid extraction by organic solvents. Encapsulated systems, which contained a hydrophobic core of solvent and an alginate-based wall, were characterized for some solvents, which were toxic by direct contact with cells. Mass transfer of ethanol was studied for all systems for determining the limiting diffusion layer. **Chapter 8** contains the general conclusions and perspectives of this work by discussing an optimized strategy for the production of ethanol from whey.

8. Nomenclature

BOD ₅	Biological Oxygen Demand. The amount of dissolved oxygen consumed in five days by biological processes breaking down organic matter
DM	Dry matter
ETBE	Ethyl-tertio-buthyl-ether, obtained by reaction of anhydrous ethanol with isobutene. ETBE is now used in petrol as an additive
ISPR	<i>In situ</i> product recovery
NF	Nanofiltration
OFEN	Federal Office of Energy
RO	Reverse osmosis
CHF	Swiss franc
UF	Ultrafiltration

9. References

- [1] Ward OP. Fermentation biotechnology principles, processes and products. In: Milton Keynes. Unighted Kingdom.: Open University Press; 1989.
- [2] Workman WE, Day DF. The cell wall-associated inulinase of *Kluyveromyces fragilis*. *Antonie van Leeuwenhoek* 1984; 50: 349-353.
- [3] Bacci Júnior M, Siqueira CG, Antoniazi SA, Ueta J. Location of the β -galactosidase of the yeast *Kluyveromyces marxianus* var. *marxianus* ATCC 10022. *Antonie van Leeuwenhoek* 1996; 69: 357-361.
- [4] Fiduciaire de l'économie laitière S.à.r.l., editor. Statistique laitière de la Suisse. Brougg: Secrétariat de l'Union Suisse des paysans; 2006.
- [5] Kim S, Dale BE. Global potential bioethanol production from wasted crops and crop residues. *Biomass and Bioenergy* 2004; 26: 361-375.
- [6] Lin Y, Tanaka S. Ethanol fermentation from biomass resources: current state and prospects. *Applied Microbiology and Biotechnology* 2006; 69: 627-642.
- [7] Sanchez, OJ, Cardona CA. Trends in biotechnological production of fuel ethanol from different feedstocks. *Bioresource Technology* 2008; 99: 5270-5295.
- [8] Fromentin A, Biollay F, Dauriat A, Lucas-Porta H, Marchand JD, Sarlos G. Caractérisation de filières de production de bioéthanol dans le contexte helvétique. EPFL; 2000a.
- [9] Jones TD, Havard JM, Daugulis AJ. Ethanol production from lactose by extractive fermentation. *Biotechnology Letters* 1993; 15: 871-876.
- [10] Lichts FO. World ethanol & biofuels report. European Biodiesel Board welcomes EU biofuel directive 2003; volume 1.
- [11] Silveira WB, Passos F, Mantovani HC, Passos FML. Ethanol production from cheese whey permeate by *Kluyveromyces marxianus* UFV-3: A flux analysis of oxidoreductive metabolism as a function of lactose concentration and oxygen levels. *Enzyme and Microbial Technology* 2005; 36: 930-936.
- [12] Thomet A, Rehberger B, Agroscope Liebefeld Posieux. Obtention de sirop de sucre à partir de lactosérum. *Revue Suisse Agricole* 2005; 37: 25-30.
- [13] González MI. The biotechnology utilization of cheese whey: a review. *Bioresource technology* 1996; 57: 1-11.
- [14] Gardner D. New technologies in the conversion of whey to high protein products. *Modern Dairy* 1989; 68: 15-17.
- [15] Kemp DL, Quickenden J. Whey processing for profit - a worthy alternative. In: Greenshield R editors. Resources and applications of biotechnology- the new wave. Basingstoke: Macmillian; 1989. p. 323-331.
- [16] Gianetto A, Berruti F, Glick BR, Kempton AG. The production of ethanol from lactose in a tubular reactor by immobilized cells of *Kluyveromyces fragilis*. *Applied Microbiology and Biotechnology* 1986; 24: 277-281.

- [17] Grba S, Stehlik-thomas V, Stanzer D, Vahcic N, Skrlin A. Selection of yeast strain *Kluyveromyces marxianus* for alcohol and biomass production on whey. *Chemistry and Biochemistry Engineering Quarterly* 2002; 16: 13-16.
- [18] Gong CS, Cao NJ, Du J, Tsao GT. Ethanol production from renewable resources. *Advances in Biochemical Engineering/Biotechnology* 1999; 65: 207-241.
- [19] Office fédéral de l'environnement. Emissions polluantes du trafic routier de 1950 à 2020. In: Département de l'environnement, des transports, de l'énergie et de la communication (OFETP). SRU-255-T; 2000: pp. 82.
- [20] Office fédéral de l'environnement. Le climat est entre nos mains. In: Département de l'environnement, des transports, de l'énergie et de la communication (OFETP). DIV-5511-F; 2002: pp. 24.
- [21] Krummenacher P, Kernén M. Développement d'une filière de carburant au bioéthanol. Planair; 2002.
- [22] Ferrari MD, Loperena L, Varela H. Ethanol production from concentrated whey permeate using a fed-batch culture of *Kluyveromyces fragilis*. *Biotechnology Letters* 1994; 16: 205-210.
- [23] Ghaly AE, Kamal M. Submerged yeast fermentation of acid cheese whey for protein production and pollution potential reduction. *Water Resource* 2004; 38: 631-644.
- [24] Schingoethe DJ. Whey utilization in animal feeding: a summary and evaluation. *Journal of Dairy Science* 1976; 59(3): 556–570.
- [25] Thivend P. Use of whey in feeding ruminants: with particular reference to pollution problems. *World Animal Review* 1977; 23: 20.
- [26] Fromentin A, Biollay F, Dauriat A, Lucas-Porta H, Marchand JD, Sarlos G. Caractérisation de filières de production de bioéthanol dans le contexte helvétique: Annexes au rapport. EPFL; 2000b.
- [27] von Stockar U, Marison IW. Unconventional utilization of whey in Switzerland. In: Ghose TK editors. *Bioprocess Engineering*. Oxford: IRS Press; 1989. p. 343-365.
- [28] Zah R, Böni H, Gauch M, Hirsch R, Lehmann M, Wäger P. Ökobilanz von Energieprodukten: ökologische Bewertung von Biotreibstoffen. In: Bundesamt für Energie (BFE), Umwelt (BAFU) und Landwirtschaft (BLW). EMPA; 2007.
- [29] Fruteau de Lacroix H, Membrez Y. Energie à partir de petit-lait: comparaison des filières biogaz et bioéthanol. In: Programme de recherche énergétique, biomasse. Office fédéral de l'énergie (OFEN). Aclens: EREP; 2004.
- [30] Knothe G. Introduction: what is biodiesel?. In: G. Knothe, J. Krahl and J.V. Gerpen editors. *The Biodiesel Handbook*. AOCS Press. Illinois; 2005, pp. 1-3.
- [31] Nelson RG, Schrock MD. Energetic and economic feasibility associated with the production, processing, and conversion of beef tallow to a substitute diesel fuel. *Biomass Bioenergy* 2006; 30: 584-591.
- [32] National Biodiesel Board, 2007. Energy content. www.biodiesel.org/pdf_files/fuelfactsheets/BTU_Content_Final_Oct2005.pdf.
- [33] Hansen AC, Zhang Q, Lyne PWL. Ethanol–diesel fuel blends—a review. *Bioresource Technology* 2005; 96: 277.

- [34] Zhang RD, He H, Shi XY, He BQ, Wang JX. Electroacupuncture combined with indomethacin enhances antihyperalgesia in inflammatory rats. *Journal of Environmental Science* 2004; 16: 793.
- [35] Corro G, Ayala E. Bioethanol and diesel/bioethanol blends emissions abatement. *Fuel* 2008; 87: 3537-3542.
- [36] Costa AC, Atala DIP, Maugeri F, Maciel R. Factorial design and simulation for the optimization and determination of control structures for an extractive alcoholic fermentation. *Process Biochemistry* 2001; 37: 125-137.
- [37] Ballesteros M, Oliva JM, Negro MJ, Manzanares P, Ballesteros I. Ethanol from lignocellulosic materials by a simultaneous saccharification and fermentation process (SFS) with *Kluyveromyces marxianus* CECT 10875. *Process Biochemistry* 2004; 39: 1843-1848.
- [38] Dale MC, Eagger A, Okos MR. Osmotic inhibition of free and immobilized *Kluyveromyces-marxianus* anaerobic growth and ethanol productivity in whey permeate concentrate. *Process Biochemistry* 1994; 29(7): 535-544.
- [39] Fonseca GG, Gombert AK, Heinzle E, Wittmann C. Physiology of the yeast *Kluyveromyces marxianus* during batch and chemostat cultures with glucose as the sole carbon source. *FEMS Yeast Resource* 2007; 7: 422-435.
- [40] Rosa FM, Sa-Correia I. Ethanol tolerance and activity of plasma membrane ATPase in *Kluyveromyces marxianus* and *Saccharomyces cerevisiae*. *Enzyme and Microbial Technology* 1992; 14: 23-27.
- [41] de Glutz FN, Dauriat A. Potentiel de réduction des coûts de la production de bioéthanol à partir de petit-lait. Eners and LGCB; 2005.
- [42] Brady D, Logan SR, McHale AP. The effect of soluble alginate and calcium on β -galactosidase activity produced by the thermotolerant, ethanol-producing yeast strain *Kluyveromyces marxianus* IMB3. *Bioprocess Engineering* 1998; 18: 101-104.
- [43] Duvnjak Z, Houle C, Mok KL. Production of ethanol and biomass from various carbohydrates by *Kluyveromyces fragilis*. *Biotechnology Letters* 1987; 9: 343-346.
- [44] Barron N, Marchant R, McHale L, McHale AP. Partial characterization of β -glucosidase activity produced by *Kluyveromyces marxianus* IMB3 during growth on cellobiose containing media at 45°C. *Biotechnology Letters* 1995; 17: 1047-1050.

Chapter 2

Process design and economic
evaluation for ethanol production
from cheese whey

1. Abstract

Possible pathways for producing bioethanol from whey were investigated. Three major production strategies were identified and characterized: centralized, decentralized and hybrid, depending on the site where treatment steps occur. Hybrid scenarios were shown to be economically more suitable than the other two strategies due to the reduction of energy and transport costs. Two scenarios, which present different fermentation strategies, were studied into detail to make economic evaluations for the valorization of cheese whey. The first scenario describes the direct fermentation of whey into ethanol using *Kluyveromyces fragilis*, while second scenario depicts hydrolyzed whey fermentation using *Saccharomyces cerevisiae*. The economic comparison shows that both scenarios result in a similar production cost (~1.30 CHF/L_{EtOH}), since the improvement in ethanol yield using *S. cerevisiae*, compared to *K. fragilis*, is compensated by the extra costs resulting from the hydrolysis step, which is necessary to achieve substrate assimilation by this non-lactose metabolizing strain. Therefore, it cannot be concluded that one strategy is more appropriate than the other with the depicted working conditions. Transport and concentration were shown to be critical steps of the global process and the optimal strategy consists in concentrating whey permeate to 300 g/L sugar prior to transport.

This chapter was submitted for publication in *Journal of Dairy Science* de Glutz FN, Holliger C, Marison IW. Process design and economic evaluation for ethanol production from cheese whey.

2. Introduction

The Swiss dairy industry generates more than 4000 million tonnes of milk per year, of which a third is dedicated to cheese production [1]. The present study explores the valorization of the resulting large quantities of cheese whey by producing bioethanol, taking into account the constraints of countries like Switzerland. Produced by multiple, widely distributed, milk-producers and dairies, whey transport and logistics represent real challenges when producing ethanol and multiple production pathways are therefore conceivable.

The principal organism studied for ethanol fermentation from whey is *Kluyveromyces fragilis* due to its ability to directly ferment lactose [2-5]. However, such direct fermentation yeasts generally suffer from low conversion yields and poor tolerance to ethanol, which results in large volumes of diluted ethanol and thus high energy demands for distillation and purification [6, 7]. An alternative is to utilize indirect fermentation yeasts, such as *Saccharomyces cerevisiae*, which show considerably better ethanol fermentation performance [8] but have the disadvantage that an expensive enzymatic hydrolysis step is required prior to fermentation.

Consequently the decision must be made as to whether the dilute whey is transported to a centralized production plant or whether to hydrolyze the lactose contained in whey into glucose and galactose prior to fermentation to enable fermentation to higher alcohol concentrations, thereby resulting in reduced distillation costs. A further decision would be whether the whey is transported to a centralized production plant or whether it is commercially viable to transform it at the production site.

3. **Materials and Methods**

Process analysis for ethanol production was carried out using the software ASPEN PLUS (ver. 12.1). From a multitude of different scenarios, two were analyzed in more detail. They differed in fermentation strategy: Scenario I considered direct lactose fermentation using *K. fragilis* and the scenario J enzymatic hydrolysis of lactose followed by glucose-galactose fermentation using *S. cerevisiae*. Operating parameters were given by Fruteau de Laclos and Membrez (EREP) [12], which reported an earlier economic evaluation of direct centralized ethanol production from whey permeate. One hundred percent carbon source assimilation was assumed, together with the presence of pre-existing refrigeration units at the production sites.

The price of the carbon source and major raw materials are (CHF per tonne) [13]: whey, 0; whey protein concentrate (WCP), 125; distillation residues, 0; NaOH, 360; H₂SO₄, 340; steam, 50; water, 0.15; electricity, 100; waste water treatment, 2; transport, 0.31 per km.

Figure 1 shows a schematic representation of the different operation units, which can be found in a centralized ethanol production plant from whey permeate and was designed by Maguin-Interis [14]. Whey permeate is first cooled (E201) and stored at 5°C (R201) prior to feeding the fermentation unit. The fermentation unit is composed of two vessels, which produce the biomass (R411 and R412) necessary to inoculate the six fermentation vessels (R421 to R426) operating in batch mode. A buffering tank (R430) collects the fermented beer containing 5% v/v alcohol and controls the beer flow rate entering the distillation column (C510 and C520). Ethanol is concentrated through distillation to 93% v/v and is dehydrated in the dehydration section by a molecular sieve (C515 and C525) to obtain fuel-grade ethanol 99.7% v/v. The purchase costs of the equipment for the simulated scenarios of this study were provided by Maguin-Interis (rue Albert Einstein12, 77420 Champs-sur-Marne, France) [14]. Hydrolysis-related costs were provided by Valio (Meijeritie 6, 00370 Helsinki, Finland), which specializes in industrial enzymatic conversion processes. Ultra-filtration, nano-filtration and evaporation-related costs were provided by the dairy research center Agroscope Liebefeld-Posieux (ALP; Cédric Fragnière, Schwarzenburgstrasse 161, 3003 Liebefeld-Bern, Switzerland). Transport-related costs were provided by taxes on truck transportation layout (RPLP) with data corresponding to the latest EURO 3 prices (www.admin.ch).

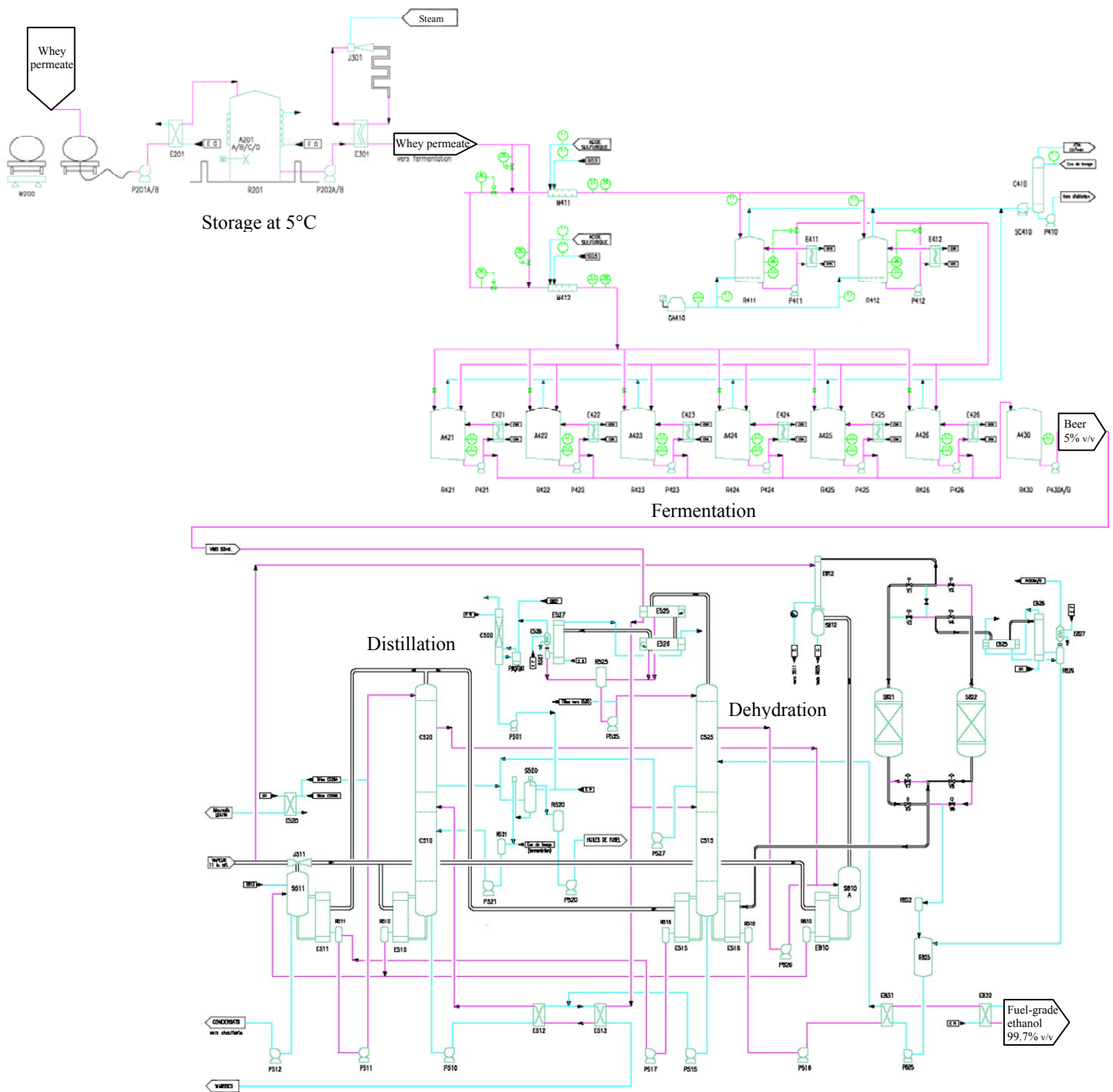

Figure 1. Process flowsheet of a centralized ethanol production plant from concentrated whey permeate. The whey permeate is refrigerated and stored at 5°C then feeds the fermentors, where a 5% v/v beer is produced. Successive distillation and dehydration produce fuel-grade ethanol at the end of the process [14].

4. Results and Discussion

4.1 Production pathways

Bioethanol production strategies can be classified in two main categories according to where the bioprocess occurs. The different pathways for centralized or decentralized production strategies are reported in Figure 2.

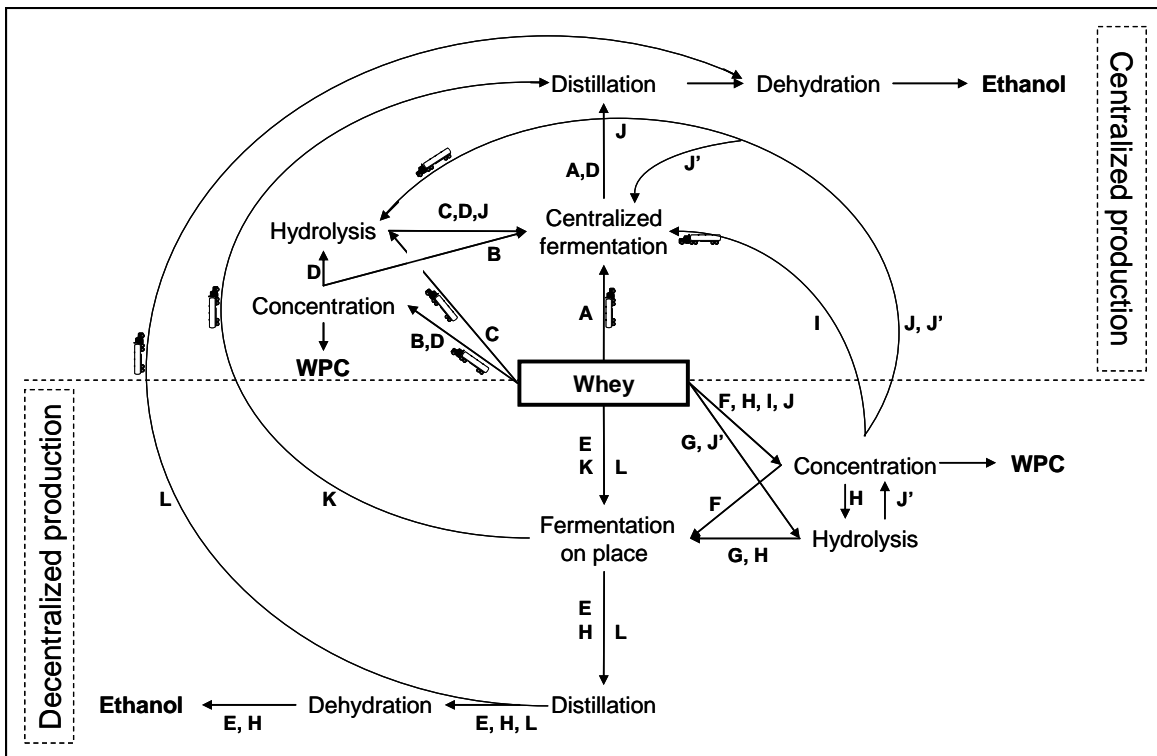

Figure 2. Possible ethanol production pathways from whey in either centralized, decentralized and hybrid production strategies. Scenarios A to D are possible totally centralized production pathways, where ethanol is produced in a unique common production plant; while scenarios E to H represent totally decentralized strategies, where ethanol is directly produced at the whey production site. Scenarios I to L depict the possible hybrid possibilities to produced ethanol, where part of the operating steps are first made at the production site than in a centralized production plant.

4.1.1 *Totally centralized production strategy*

The term centralized production is used when all the operating steps are performed in one common plant. Whey is thus gathered to a centralized plant where it is pre-treated, fermented, distilled and dehydrated for providing fuel-grade ethanol (99.7 % v/v) as a final product.

In scenario A, raw dilute whey, 5% dry matter (DM) (45 g/L lactose) [15], is transported to the fermentation plant and fermented by lactose-utilizing yeast, such as *Kluyveromyces fragilis*, prior to distillation and dehydration.

Scenario B is a variant of the previous scenario, which includes extra ultrafiltration and nanofiltration units which retain whey proteins and concentrate the resulting permeate to 22% DM (190 g/L) prior to fermentation [16]. This operation would enable to obtain a higher final ethanol concentration after the fermentation, since the substrate would be less diluted, and recover as a by-product the proteins of whey. Another advantage of concentrating the substrate would lie in the reduction of the working volumes, since unnecessary water is discarded.

Scenario C is similar to scenario A but contains an additional hydrolysis unit, which converts enzymatically the lactose into glucose and galactose using β -D-galactosidase prior to fermentation [17]. This would enable fermenting the hydrolyzed whey by non-lactose-utilizing yeasts such as *Saccharomyces cerevisiae*, which usually exhibit better ethanol conversion yields compared to *K. fragilis* [8].

Scenario D concentrates and hydrolyses whey. Hydrolyzed 22% DM whey permeate is then fermented by *S. cerevisiae*, which usually exhibits higher ethanol concentrations compared to *K. fragilis*. Distillation of such a concentrated “beer” would result in saving energy, since less material would enter the column [7].

4.1.2 *Totally decentralized production strategy*

The term decentralized production describes the case, where each individual production site owns all the operating units of the process, which are required to produce fuel-grade ethanol.

In scenario E, raw dilute whey is directly fermented at the production site by *K. fragilis*. The fermentation broth is then distilled and dehydrated.

Scenarios F, G and H are equivalent to scenarios B, C and D in the case of a totally decentralized production strategy. The advantages of using concentration and hydrolysis units are identical to the previously described scenarios (B, C and D).

4.1.3 *Hybrid production strategy*

A hybrid production strategy is when parts of the process are done at the production site and others are regrouped in a common plant. This is the case for scenarios I, J, J', K and L, where some operations are first performed at the whey production site prior to carrying out the remaining steps in a centralized plant.

Scenario I describes the situation where NF-whey concentrate is produced at the production site prior to transportation to a centralized plant where it is fermented, distilled and dehydrated. Such a strategy results in a less diluted substrate and therefore smaller liquid quantities, which would result in reducing the transportation costs.

Scenarios J and J' integrate an extra hydrolysis step to the previous scenario. In the former case, NF-whey concentrate is transported to the centralized plant where it would be hydrolyzed prior to fermentation, and in the latter case, whey would be hydrolyzed prior to concentration and transport. While whey cannot be concentrated to more than 22% DM due to the low solubility of lactose (240 g/L at 20°C) [18] resulting in crystallization during transport and storage, glucose and galactose may be concentrated to much higher levels. A benefit would be a further reduction of the transport costs compared to NF-whey concentrate. Whey and whey permeate are unstable substrates because of microbial activity naturally present in whey and cheese industries, with concentrated whey permeate (12% DM) reported to be stable for only 2-3 days at 4°C [19]. The instability is mainly the result of growth of the bacterial flora causing conversion of lactose to lactic acid resulting in a reduction of pH and bioethanol production yield. Another advantage of this whey concentration would thus be a stabilizing effect, comparable to molasses, which would enable transporting and storing concentrated, hydrolyzed whey permeate at room temperature for a much longer period.

Scenario K consists in fermenting either dilute or concentrate whey at the production site and then transporting the fermented “beer” to a centralized plant where it would be distilled and dehydrated. This scenario has the advantage of avoiding problems associated with whey instability during transport and storage and the centralized ethanol concentration plant would help rationalizing energy consumption and therefore reduce operating costs.

The last envisaged scenario (L) is similar to the previous except that distillation would still occur at the production site and only dehydration would then be performed in a centralized plant. In this situation transportation costs would be reduced almost 40-fold compared to dilute whey (1 liter of 93% v/v ethanol is produced from 41 liter dilute whey permeate).

4.1.4 Strategies analysis

Whey was depicted as a dilute substrate (5% DM, 45 g/L lactose), which would result in significant costs to transport from the production sites to a central facility. These costs can be reduced by pre-concentration of the whey at the production site using nanofiltration (22% DM, 190 g/L lactose) or evaporation (70% DM, 600 g/L glucose-galactose) following a hydrolysis step. However, the more the whey is concentration, the higher the operating costs. Figure 3 shows the operating costs for concentrating 1 tonne of dilute whey and the resulting transportation costs.

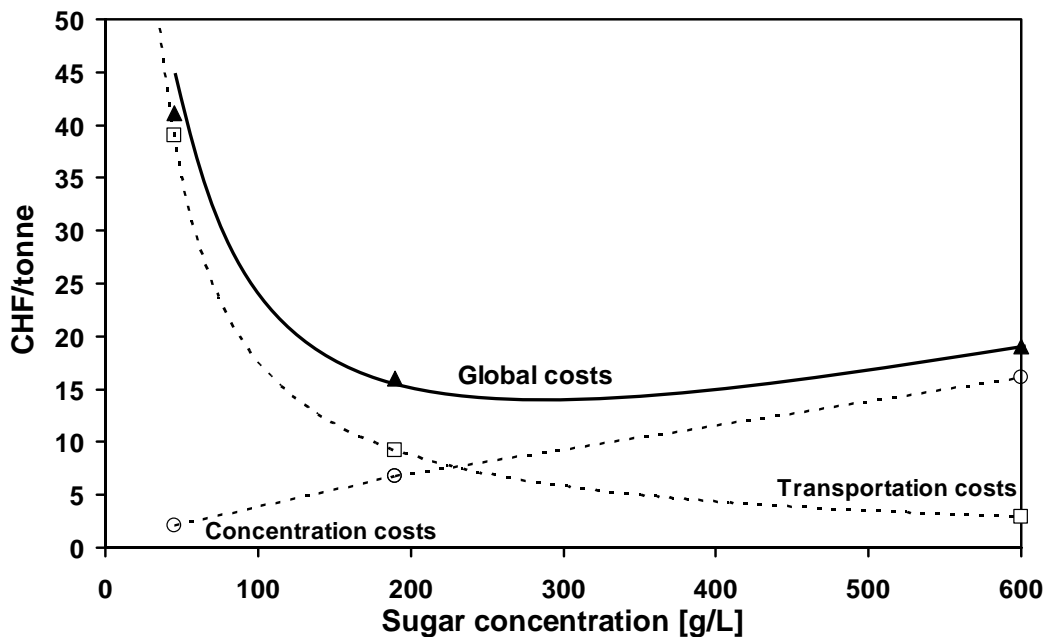

Figure 3. Balance of concentration and transportation costs to determine optimal profitability.

Transportation costs are linked to the substrate volume (0.31 CHF/tonne·km over an average distance of 120 km) [13], and thus decrease with the sugar concentration. Nanofiltrating whey prior to transport would therefore decrease transportation costs by 4-fold compared to dilute whey, while subsequently evaporating water up to 600 g/L glucose-galactose would result in 40% more savings. The trend of the concentration costs, dimensioned for the treatment of 1 million tonne of whey per year (1kWh=1 CHF) [13], is almost linear from 45g/L to 600 g/L of sugar. While nanofiltration costs are mainly dependent on the membrane costs [13], the operating cost for evaporation is fixed by the energy required (100 kWh·tonne) [20], and is therefore linear. Combination of both concentration and transportation costs shows that a

sugar concentration around 300 g/L would represent the optimum compromise conditions. For this reason scenarios A to D, which consider transportation of dilute whey, would not be economically feasible. According to scenario J' in Figure 3, which includes evaporation-concentration of hydrolyzed-whey permeate, this would be almost equivalent to scenario J which depicts transportation of NF-whey concentrate.

In the case where ethanol is produced through a totally decentralized strategy (scenario E), the average production volumes and logistics must first be considered. In 2003, the association Fromarte made an inventory of the main milk-producers in Switzerland [21]. A typical production of 1 million tonne of whey per year [21] was reported for more than 600 dairies, which represents a total of $1200 \cdot 10^3$ tonnes of whey per year. This average yearly production corresponds to a daily production of about 3000 L of raw whey, which after fermentation ($0.4 \text{ g}_{\text{EtOH}}/\text{g}_{\text{lactose}}$) [6], distillation and dehydration would result in about only 50 L of fuel-grade ethanol per day. Therefore constructing and operating hundreds of disperse ethanol production plants, which can only produce small amounts of ethanol, does not appear economically reasonable. Similar arguments concern the other totally decentralized scenarios, such as scenario F, G and H and almost totally decentralized scenarios, such as K and L.

For this reason, the most conceivable economically profitable strategy would consist in nanofiltrating whey at the production site prior to transportation to a centralized treatment plant, where NF-whey concentrate is fermented by either *K. fragilis* (scenario I) or hydrolyzed prior to fermentation with *S. cerevisiae* (scenarios J and J'). Only scenario J will be simulated as a more comparable situation to scenario I, but results should provide similar results to J' according to Figure 3.

4.2 Centralized direct fermentation of concentrated whey permeate (scenario I)

This deals with a cheese factory that produces whey as a by-product, concentrates it to 22% DM to obtain nano-filtrated (NF) whey concentrate and whey protein concentrate (WPC). Concentrated NF whey permeate is transported to a centralized treatment plant that produces fuel-grade ethanol. The development of the process was based on data available in the literature [12-14]. On a yearly basis, for the production of $325 \cdot 10^3$ tonnes of whey, the plant processes $11.1 \cdot 10^3$ tonnes of WPC and $5.3 \cdot 10^3$ tonnes ethanol ($6.7 \cdot 10^6$ L). The plant operates around the clock for 330 days a year. This scenario consists of six sections: whey concentration, refrigeration, transport, ethanol fermentation, distillation and dehydration.

4.2.1 Process description

Whey concentration section: Using three successive concentration units, 5% DM whey is concentrated to 22% DM containing mainly soluble proteins, salts, lactose and water. The proteins with the highest molecular weight are separated using a ceramic ultrafiltration (UF) filter. The liquid permeate from the ultra-filters is treated using a cross flow nano-filter at around 50°C, which concentrates it to 22% DM, 190 g/L lactose, whey permeate and retains proteins of smaller size [16], which are then spray-dried to produce solid WPC containing 50-75% protein.

Refrigeration section: Since whey is a naturally very unstable, biologically degradable material, it must be refrigerated. This is achieved by passing NF whey permeate through a cooler to reduce its temperature to 5°C.

Transport section: The concentrated substrate is transported by refrigerated truck to the centralized treatment plant. An average distance of 120km was estimated [13], during which the temperature must be maintained at 5°C.

Ethanol section: NF whey permeate (190 g/L lactose) is first re-diluted to 105 g/L lactose because this is the maximum lactose concentration which can be fermented by *Kluyveromyces fragilis* before being limited by ethanol. This medium is fed to the fermentor, where a lactose-fermenting yeast is used to produce ethanol. With a conversion yield of 0.375 g_{EtOH}/g_{lactose} [22], a “beer” containing 5% alcohol (by volume) [14, 23] is produced. The beer is then sent to a centrifugal separator, which recovers and recycles the yeast. Complete (100%) lactose utilization was expected.

Distillation section: The biomass-free permeate is then pre-heated through a heat-exchanger before distillation. Heat-exchange integration is used to warm the incoming solution using the bottom stream from the distillation column. Next the dilute ethanol solution is concentrated by distillation, with a valve-distillation column of 50 theoretical plates, to spirit-grade level (93% v/v).

Dehydration section: The azeotrope is exceeded by molecular sieves and is concentrated to fuel-grade level (99.7% v/v) [24].

4.2.2 *Costs analysis and economic evaluation*

The economic evaluation gave an overview of total economic impact of the plant, including total capital investment and detailed yearly operating costs. The total equipment purchase cost (Table 1A) is around 12.3 million CHF. Fermentation has the most expensive equipment costs (4'248'000 CHF/Unit). The installation of multiple concentration units of small size makes installation and maintenance of this part of the process the second most expensive for equipment (3'666'000 CHF/Unit).

The annual operating cost (Table 1B) was calculated by taking into account equipment depreciation and maintenance, operating labor, administrative work, raw materials purchase, utilities requirements, disposal costs, transportation fees and by-product valorization, and was found to be 9.1 million CHF/year. Clearly the transport-dependent cost is the most important item accounting for 30% (2'747'000 CHF/year) of the total operating cost. The cost of concentration lies in second position accounting for 19% of the total cost followed by fermentation-dependent cost (18%). As mentioned previously, decentralization of the concentration units results in higher labor operating costs. The reduction of labor operating cost of this section in a totally centralized treatment plant may result in a profitable operation unit. For Switzerland, since transport was shown to be the critical step, substrate concentration after transportation of dilute whey would result in a 2-fold higher operation cost. Direct fixed capital (DFC) related costs and specific know-how for operating a fermentation unit are the most important costs of this section. While DFC-related costs, such as maintenance, are the most significant expenses for the dehydration section, distillation operating costs were shown to be directly linked to utilities, and more specifically steam, which represents almost 60% of the total annual operating cost of this section (15%). Finally, refrigeration accounts for 8% of overall annual operating costs. This cost is only related to cooling energy, since it was assumed that local milk producers already possess the necessary heat-exchange units.

The contribution of the various unit operation costs (Figure 4) to the final ethanol production price (**1.35 CHF/L_{E_tOH}**), is as follows: concentration 0.26 CHF/L_{E_tOH}, refrigeration 0.11 CHF/L_{E_tOH}, transport 0.41 CHF/L_{E_tOH}, fermentation 0.24 CHF/L_{E_tOH}, distillation 0.20 CHF/L_{E_tOH} and dehydration 0.13 CHF/L_{E_tOH}.

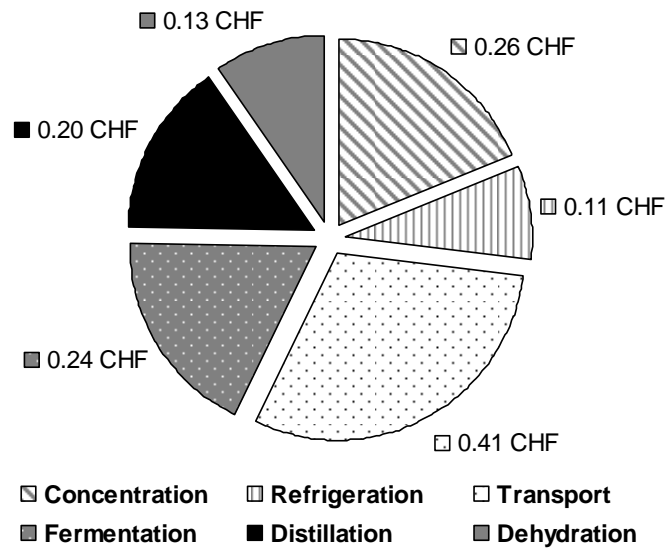

Figure 4. Contribution of the individual operating units to the total production cost of ethanol produced in a centralized production plant treating $325 \cdot 10^6$ L_{whey}/year with *Kluyveromyces fragilis*.

Table 1. Economic analysis of ethanol production in a centralized production plant including direct lactose fermentation using *Kluyveromyces fragilis*; (A) the direct fixed investment capital and (B) annual operating costs for the yearly production of $6.7 \cdot 10^6$ L ethanol.

A		Concentration	Fermentation	Distillation	Dehydration	Total
FIXED CAPITAL ESTIMATE (2004 prices)						
A. TOTAL PLANT DIRECT COST (TPDC) (physical cost)		cost (CHF)	cost (CHF)	cost (CHF)	cost (CHF)	cost (CHF)
a. Equipment Purchase Cost	(PC)	1'470'000	2'100'000	870'000	1'300'000	
b. Installation		956'000	525'000	218'000	325'000	
c. Process Piping	(0.09 X PC)	132'000	189'000	78'000	117'000	
d. Instrumentation	(0.10 X PC)	147'000	210'000	87'000	130'000	
e. Insulation	(0.008 X PC)	12'000	17'000	7'000	10'000	
f. Electrical	(0.025 X PC)	37'000	53'000	22'000	33'000	
g. Buildings	(0.11 X PC)	162'000	231'000	96'000	143'000	
h. Yard Improvement	(0.04 X PC)	59'000	84'000	35'000	52'000	
i. Auxiliary Facilities	(0.10 X PC)	147'000	210'000	87'000	130'000	
		3'122'000	3'619'000	1'500'000	2'240'000	
B. TOTAL PLANT INDIRECT COST (TPIC)						
a. Engineering	(0.06 X TPDC)	187'000	217'000	90'000	134'000	
b. Construction	(0.08 X TPDC)	250'000	289'000	120'000	179'000	
		437'000	506'000	210'000	313'000	
C. OTHER COSTS (OTC)						
a. Contractor's fee	(0.01 X (TPDC + TPIC))	36'000	41'000	17'000	26'000	
b. Contingency	(0.02 X (TPDC + TPIC))	71'000	82'000	34'000	51'000	
		107'000	123'000	51'000	77'000	
D. DIRECT FIXED CAPITAL (DFC)						
TPDC + TPIC + OTC		3'666'000	4'248'000	1'761'000	2'630'000	12'305'000

B		Concentration	Refrigeration	Transport	Fermentation	Distillation	Dehydration	Total
ANNUAL OPERATING COST (2004 prices)								
		cost (CHF)	cost (CHF)	cost (CHF)	cost (CHF)	cost (CHF)	cost (CHF)	cost (CHF)
A. DFC-DEPENDENT ITEMS								
Depreciation		348'000			404'000	167'000	250'000	
Maintenance Material		35'000			40'000	17'000	25'000	
Insurance	(0.01 X DFC)	37'000			42'000	18'000	26'000	
Local Taxes	(0.02 X DFC)	73'000			85'000	35'000	53'000	
Factory Expense	(0.05 X DFC)	183'000			212'000	88'000	132'000	
		676'000	0 ¹	0 ²	783'000	325'000	486'000	
B. LABOR-DEPENDENT ITEMS								
a. Operating labor		600'000			210'000	70'000	70'000	
b. Maintenance labor		189'000			63'000	21'000	21'000	
c. Fringe benefits	(0.40 X (a + b))	328'000			109'000	36'000	36'000	
d. Supervision	(0.20 X (a + b))	164'000			55'000	18'000	18'000	
e. Operating supplies	(0.10 X a)	63'000			21'000	7'000	7'000	
f. Laboratory	(0.15 X a)	95'000			32'000	11'000	11'000	
		1'439'000	0 ¹	0 ²	490'000	163'000	163'000	
C. ADMINISTRATION AND OVERHEAD EXPENSE								
	(0.6 ' (a+b+c))	688'000	0 ¹	0 ²	229'000	76'000	76'000	
D. RAW MATERIALS								
a. Carbon source	(0 CHF/tonne)							
b. NaOH	(360 Srf/tonne)	1'000			1'000			
c. H ₂ SO ₄	(320 Srf/tonne)	1'000			41'000			
d. others					29'000			
		2'000	0	0	71'000	0	0	
E. OTHER CONSUMABLES								
Membrane or filter cloth		42'000	0	0	0	0	0	
F. UTILITIES								
a. Steam	(50 Srf/tonne)	7'000 ³				775'000 ³	165'000 ³	
b. Water	(0.15 Srf/tonne)	14'000 ³			7'000 ³			
c. Energy	(100 CHF MWh)	235'000 ³	737'000		60'000 ³	12'000 ³	4'000 ³	
		256'000	737'000	0	67'000	787'000	169'000	
G. WASTE TREATMENT/DISPOSAL								
	(2 Srf/tonne)	9'000	0	0	0	13'000 ³	0	
H. TRANSPORT								
	(0.31 CHF/tonne km)	0	0	2'747'000	0	0	0	
I. BY PRODUCT VALORIZATION								
		-1'388'000	0	0	0	0	0	
Total annual operating cost		1'724'000	737'000	2'747'000	1'640'000	1'364'000	894'000	9'106'000

¹ is was assumed that local milk-producers already possess the necessary heat-exchange units

² expenses related to vehicles and salaries are already comprised in the transport costs

³ values obtained by simulations with ASPEN Plus

4.3 Centralized indirect fermentation of concentrated whey permeate (scenario J)

Whey concentration, refrigeration, transport, distillation and dehydration sections are similar to the direct centralized concentrated whey permeate fermentation process (scenario J). The main differences are those in ethanol production, with *Saccharomyces cerevisiae*, and an additional hydrolysis section for converting lactose into glucose and galactose.

Hydrolysis section: NF whey permeate (19% lactose) is fed to a fixed-bed reactor containing β -galactosidase enzymes, which are immobilized on porous matrixes. This system, currently commercialized by Valio (www.valio.fi), converts the lactose into glucose and galactose with a conversion yield of 95%.

Ethanol section: Hydrolyzed substrate enters the fermentor, where *S. cerevisiae* converts glucose and the galactose into ethanol with a conversion yield of $0.492 \text{ g}_{\text{EtOH}}/\text{g}_{\text{sugar}}$ [23]. The fermented product contains 11% alcohol (by volume) [13] and assumes complete (100%) carbon source utilization. Next the beer is sent to a centrifugal separator, which recovers and recycles the yeast.

As a result of the higher conversion yield and ethanol tolerance of *S. cerevisiae*, a yearly ethanol production of $6.6 \cdot 10^3$ tonnes ethanol ($8.4 \cdot 10^6$ L) are produced and liquid volumes entering the distillation section are reduced by 2-fold compared to the previous scenario.

4.3.1 Economic evaluation of scenario J

The additional hydrolysis section, which is required for the conversion of lactose into glucose and galactose, in order to use *S. cerevisiae*, explains the higher final equipment purchase cost (Table 2A) of around 15.3 million CHF. Fermentation and concentration units remain the most expensive pieces of equipment, followed closely by hydrolysis units. The latter equipment purchase cost was provided by Valio Ltd. (1'500'000 CHF) and represents 20% of the DFC of the indirect centralized process. Direct costs being related to β -galactosidase purchase cost, there would be no significant difference for centralized or decentralized production.

A direct result of the indirect fermentation strategy is a higher ethanol conversion yield since glucose-galactose fermentation with *S. cerevisiae* is more efficient than direct lactose fermentation with *K. fragilis* ($0.492 \text{ g}_{\text{EtOH}}/\text{g}_{\text{sugar}}$ compare to $0.375 \text{ g}_{\text{EtOH}}/\text{g}_{\text{sugar}}$), and thus leads to the production of 30% more ethanol from the same initial quantity of whey ($8.4 \cdot 10^6 \text{ L}_{\text{EtOH}}/\text{year}$). The annual operating cost (Table 2B) was 11 million CHF/year, which is 20% more expensive than for the direct centralized scenario. Concentration, refrigeration, transport and dehydration operating costs are identical to the previously described scenario, since these steps are not affected by a change of the fermentation set-up. Raw materials and utilities-related costs of fermentation with *S. cerevisiae* do not differ from *K. fragilis*, which also results in identical operating costs for the fermentation unit. While transport-dependent cost is always the most important item, accounting for 25% of the total operating cost, hydrolysis was shown to have a critical impact on total annual operating costs in indirect fermentation strategy, since it represents more than 20% of annual operating costs (2'219'000 CHF/year). This high operating cost is mainly due to the replacement of the β -galactosidase enzymes (1'412'000 CHF/year) (Mr. Raul Lönnström, Vice president Valio international Ltd). Distillation operating costs were shown to be directly linked to the utilities, and more specifically to steam. The higher tolerance of *S. cerevisiae* compared to *K. fragilis* leads to a 2-fold higher alcohol content in the beer which feeds the distillation column. Consequently the requirements for steam are reduced by approximately 2-fold, which results in some 30% lower operating cost than with direct scenario (976'000 CHF/year). Thus distillation only accounted for 9% of annual operating costs in indirect fermentation process.

The contribution of the various operation unit costs (Figure 5) to the final ethanol production price (**1.32 CHF/L_{EtOH}**), is as follows: concentration 0.21 CHF/L_{EtOH}, refrigeration 0.09 CHF/L_{EtOH}, transport 0.33 CHF/L_{EtOH}, hydrolysis 0.26 CHF/L_{EtOH}, fermentation 0.20 CHF/L_{EtOH}, distillation 0.12 CHF/L_{EtOH} and dehydration 0.11 CHF/L_{EtOH}.

Table 2. Economic analysis of ethanol production in a centralized production plant treating fermenting hydrolyzed lactose with *Saccharomyces cerevisiae*, representing (A) the direct fixed investment capital and (B) then annual operating expenses of a yearly production of $8.4 \cdot 10^6$ L ethanol.

A		Concentration	Hydrolysis	Fermentation	Distillation	Dehydration	Total
FIXED CAPITAL ESTIMATE (2004 prices)							
A. TOTAL PLANT DIRECT COST (TPDC)	(physical cost)	cost (CHF)	cost (CHF)	cost (CHF)	cost (CHF)	cost (CHF)	cost (CHF)
a. Equipment Purchase Cost	(PC)	1'470'000	1'500'000	2'100'000	870'000	1'300'000	
b. Installation		956'000	375'000	525'000	218'000	325'000	
c. Process Piping	(0.09 X PC)	132'000	135'000	189'000	78'000	117'000	
d. Instrumentation	(0.10 X PC)	147'000	150'000	210'000	87'000	130'000	
e. Insulation	(0.008 X PC)	12'000	12'000	17'000	7'000	10'000	
f. Electrical	(0.025 X PC)	37'000	38'000	53'000	22'000	33'000	
g. Buildings	(0.11 X PC)	162'000	165'000	231'000	96'000	143'000	
h. Yard Improvement	(0.04 X PC)	59'000	60'000	84'000	35'000	52'000	
i. Auxiliary Facilities	(0.10 X PC)	147'000	150'000	210'000	87'000	130'000	
		3'122'000	2'585'000	3'619'000	1'500'000	2'240'000	
B. TOTAL PLANT INDIRECT COST (TPIC)							
a. Engineering	(0.06 X TPDC)	187'000	155'000	217'000	90'000	134'000	
b. Construction	(0.08 X TPDC)	250'000	207'000	289'000	120'000	179'000	
		437'000	362'000	506'000	210'000	313'000	
C. OTHER COSTS (OTC)							
a. Contractor's fee	(0.01 X (TPDC + TPIC))	36'000	29'000	41'000	17'000	26'000	
b. Contingency	(0.02 X (TPDC + TPIC))	71'000	59'000	82'000	34'000	51'000	
		107'000	88'000	123'000	51'000	77'000	
D. DIRECT FIXED CAPITAL (DFC)							
TPDC + TPIC + OTC		3'666'000	3'035'000	4'248'000	1'761'000	2'630'000	15'340'000

B		Concentration	Refrigeration	Transport	Hydrolysis	Fermentation	Distillation	Dehydration	Total
ANNUAL OPERATING COST (2004 prices)									
A. DFC-DEPENDENT ITEMS									
		cost (CHF)	cost (CHF)	cost (CHF)	cost (CHF)	cost (CHF)	cost (CHF)	cost (CHF)	cost (CHF)
Depreciation		348'000			288'000	404'000	167'000	250'000	
Maintenance Material		35'000			29'000	40'000	17'000	25'000	
Insurance	(0.01 X DFC)	37'000			30'000	42'000	18'000	26'000	
Local Taxes	(0.02 X DFC)	73'000			61'000	85'000	35'000	53'000	
Factory Expense	(0.05 X DFC)	183'000			152'000	212'000	88'000	132'000	
		676'000	0 ¹	0 ²	560'000	783'000	325'000	486'000	
B. LABOR-DEPENDENT ITEMS									
a. Operating labor		600'000			70'000	210'000	70'000	70'000	
b. Maintenance labor		189'000			21'000	63'000	21'000	21'000	
c. Fringe benefits	(0.40 X (a + b))	328'000			36'000	109'000	36'000	36'000	
d. Supervision	(0.20 X (a + b))	164'000			18'000	55'000	18'000	18'000	
e. Operating supplies	(0.10 X a)	63'000			7'000	21'000	7'000	7'000	
f. Laboratory	(0.15 X a)	95'000			11'000	32'000	11'000	11'000	
		1'439'000	0 ¹	0 ²	163'000	490'000	163'000	163'000	
C. ADMINISTRATION AND OVERHEAD EXPENSE									
	(0.6 ' (a+b+c))	688'000	0 ¹	0 ²	76'000	229'000	76'000	76'000	
D. RAW MATERIALS									
a. Carbon source	(0 CHF/tonne)								
b. NaOH	(360 Srf/tonne)	1'000				1'000			
c. H ₂ SO ₄	(320 Srf/tonne)	1'000				41'000			
d. others					1'412'000	29'000			
		2'000	0	0	1'412'000	71'000	0	0	
E. OTHER CONSUMABLES									
Membrane or filter cloth		42'000	0	0	0	0	0	0	
F. UTILITIES									
a. Steam	(50 Srf/tonne)	7'000 ³					387'000 ³	165'000 ³	
b. Water	(0.15 Srf/tonne)	14'000 ³			1'000	7'000 ³			
c. Energy	(100 CHF MWh)	235'000 ³	737'000		7'000	60'000 ³	12'000 ³	4'000 ³	
		256'000	737'000	0	8'000	67'000	399'000	169'000	
G. WASTE TREATMENT/DISPOSAL									
	(2 Srf/tonne)	9'000	0		0	0	13'000 ³	0	
H. TRANSPORT									
	(0.31 CHF/tonne km)	0	0	2'747'000	0	0	0	0	
I. BY PRODUCT VALORIZATION									
		-1'388'000							
Total annual operating cost		1'724'000	737'000	2'747'000	2'219'000	1'640'000	976'000	894'000	10'937'000

¹ is was assumed that local mil-producers already possess the necessary heat-exchange units

² expenses related to vehicles and salaries are already comprised in the transport costs

³ values obtained by simulations with ASPEN Plus

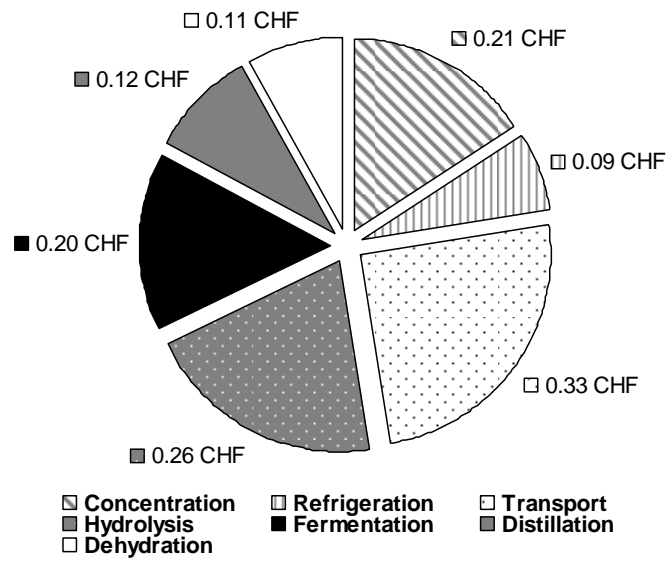

Figure 5. Contribution of the individual operating units to the total production cost of ethanol produced in a centralized production plant treating $325 \cdot 10^6$ L_{whey}/year with *Saccharomyces cerevisiae*.

5. Conclusions

The relative impact of the individual unit operations on the final ethanol production price could be identified by calculating equipment dimensions and facility requirements with a computer modeling software and adapting available earlier economic evaluations. The analysis of the multiple possible production pathways reduced the number of reasonable scenarios to 3, which are all hybrid strategies, where whey is (i) concentrated at the production site prior to transportation to a centralized treatment plant (ii) and/or hydrolyzed. A comparison of economic evaluation for two of those scenarios, which transformed 325 million tonnes of dilute cheese whey into ethanol, resulted in an almost equivalent production price for both envisaged strategies. By direct fermentation using *K. fragilis* (scenario I), a production price of 1.35 CHF/L_{EtOH} was achieved, while when fermenting using *S. cerevisiae* (scenario J), the production price was 1.32 CHF/L_{EtOH}. The EREP report [12] established an ethanol production price of 1.34 CHF/L_{EtOH} for scenario I, which differs by only 2% with the value obtained in the present study. On the other hand, a computer-aided simulation of ethanol fermentation from whey [25] was done with the software SuperPro Designer. This study, only based on computed values, reported an almost 2-fold higher production price (2.26 CHF/L_{EtOH}) and defined a breakeven point for 49.5 tonne/h of treated dilute whey permeate.

Transport and concentration were shown to be two critical steps of the global process and the profile depicted in Figure 1 would suggest an ideal concentration around 300 g/L glucose-galactose with hydrolyzed whey permeate. Whey instability is still a limiting factor of the process, since storage is limited to 3-4 days at 5°C. Evaporation would be an alternative, and additional operating costs may partially or totally offset refrigeration costs. Another possibility would, eventually, be to stabilize whey chemically. Relatively low ethanol production yield and tolerance are limiting parameters for using direct fermentation. The selection of lactose-utilizing strains must therefore focus on these two parameters.

As a perspective, more recent membrane technologies, such as pervaporation may represent an interesting alternative to molecular sieve dehydration although membrane viability would be a critical parameter to take into account before choosing such technologies.

6. Nomenclature

ASPEN	Advanced System for Process Engineering
DFC	Direct fixed costs
DM	Dry matter content
EREP	Etudes et Applications d'Energies Renouvelables et d'Epuration SA
NF	Nanofiltration
UF	Ultrafiltration
WPC	Whey protein concentrate

7. References

- [1] Fiduciaire de l'économie laitière S.à.r.l., editor. Statistique laitière de la Suisse. Brougg: Secrétariat de l'Union Suisse des paysans; 2006.
- [2] Rocha MH, Lora EES, Venturini OJ. Life Cycle Analysis of different alternatives for the treatment and disposal of ethanol vinasse. *Zuckerindustrie* 2008; 133(2): 88-93.
- [3] Thomsen MH, Hauggaard-Nielsen H. Sustainable bioethanol production combining biorefinery principles using combined raw materials from wheat undersown with clover-grass. *Journal of Industrial Microbiology & Technology* 2008; 35(5): 303-311.
- [4] Kotaka A, Bando H, Kaya M, Kato-Murai M, Kuroda K, Sahara H, Hata Y, Kondo A, Ueda M. Direct ethanol production from barley beta-glucan by sake yeast displaying *Aspergillus oryzae* beta-glucosidase and endoglucanase. *Journal of Bioscience and Bioengineering* 2008; 105(6): 622-627.
- [5] Carere CR, Sparling R, Cicek N, Levin DB. Third generation biofuels via direct cellulose fermentation. *International Journal of Molecular Sciences* 2008; 9(7): 1342-1360.
- [6] Mawson AJ. Bioconversions for whey utilization and waste abatement. *Bioresource Technology* 1994; 47: 195-203.
- [7] Tin CSF, Mawson AJ. Ethanol production from whey in a membrane recycle bioreactor. *Process Biochemistry* 1993; 28: 217-221.
- [8] Dale MC, Moelhman M, Walker S. Industrial scale production of ethanol from whey permeate mother liquor using a multi-stage continuous fermentation system. *Paper American Society of Agricultural Engineers* 1997; 3: 1-10.
- [9] Ostry ME, Anderson NA. Genetics and ecology of the *Entoleuca mammata*-*Populus pathosystem*: Implications for aspen improvement and management. *Forest Ecology and Management* 2009; 257(2): 390-400.
- [10] Nikoo MB, Mahinpey N. Simulation of biomass gasification in fluidized bed reactor using ASPEN PLUS. *Biomass & Bioenergy* 2008; 32(12): 1245-1254.
- [11] Jeon SK, Park CS, Kim SD, Song BH, Norbeck JM. Methane steam reforming for synthetic diesel fuel production from steam-hydrogasifier product. *Korean Journal of Chemical Engineering* 2008; 25(6): 1279-1285.
- [12] Fruteau de Lacos H, Membrez Y. Energie à partir de petit-lait : comparaison des filières biogaz et bioéthanol. In: Programme de recherche énergétique, biomasse. Office fédéral de l'énergie (OFEN). Aclens: EREP; 2004.
- [13] de Glutz FN, Dauriat A. Potentiel de réduction des coûts de la production de bioéthanol à partir de petit-lait. In : projet etha+. Rapport de synthèse. Lausanne : ENERS ; 2005.
- [14] Maguin-Interis. Etude budgétaire pour une unité de production d'alcool carburant à partir de petit-lait. 2270C-DE-01 Rev.0, 08.10.2002.
- [15] Vienne P, von Stockar U. Alcohol from whey permeate: strain selection, temperature and medium optimization. *Biotechnology and Bioengineering* 1983; 13: 421-435.
- [16] Thomet A, Rehberger B, Agroscope Liebefeld Posieux. Obtention de sirop de sucre à partir de lactosérum. *Revue Suisse Agricole* 2005; 37: 25-30.

- [17] Bacci Júnior M, Siqueira CG, Antoniazzi SA, Ueta J. Location of the β -galactosidase of the yeast *Kluyveromyces marxianus* var. *marxianus* ATCC 10022. *Antonie van Leeuwenhoek* 1996; 69: 357-361.
- [18] Singh RK, Shah BB. Characterisation of lactose crystallised in acidified aqueous ethanol. *Journal of the Science of Food and Agriculture* 1991; 58 (1): 161-164.
- [19] Jasewicz L, Porges N. Whey preservation by hydrogen peroxide. *Journal of Dairy Science* 1959; 42: 1119-1125.
- [20] Agence de l'Environnement et de la Maîtrise de l'Energie, 2007. Economies d'énergie. <http://www2.ademe.fr/servlet/KBaseShow?sort=-1&cid=96&m=3&catid=16051>
- [21] Fromarte, 2005. Molke-Potenzial Variantenstudie im Rahmen des Alcosuisse-Projektes etha+. www.fromarte.ch/services/molkebericht/de.pdf
- [22] Marison IW, Fromentin A, Biollay F, Dauriat A, Lucas-Porta H, Marchand JD, Sarlos G. Caractérisation de filières de production de bioéthanol dans le contexte helvétique. Bern : Office fédéral de l'énergie (OFEN) ; 2000.
- [23] Marison IW, Fromentin A, Biollay F, Dauriat A, Lucas-Porta H, Marchand JD, Sarlos G. Caractérisation de filières de production de bioéthanol dans le contexte helvétique: Annexes au rapport. Bern : Office fédéral de l'énergie (OFEN) ; 2000.
- [24] Krummenacher P, Kernen M. Développement d'une filière de carburant au bioéthanol. Planair; 2002.
- [25] Kotoupas A, Rigas F, Chalaris M. Computer-aided process design, economic evaluation and environmental impact assessment for treatment of cheese whey wastewater. *Desalination* 2007; 213: 238-252.

Chapter 3

Stabilization of whey permeate
to enable ethanol production by
Kluyveromyces marxianus

1. **Abstract**

A major limitation to the use of whey and whey permeate for the production of bioethanol is the high instability due to lactic acid bacteria present in the whey after the cheese production process, which grow and consume lactose during subsequent storage and transport. Thus even when stored at 4°C whey permeate is only stable for 2-3 days. In order to overcome this, seven compounds were tested for their ability to stabilize ultrafiltrated- and reverse osmosed-treated whey permeates over a period of 21 days. Of these compounds, formic acid was selected due to the high level of growth inhibition of lactic acid bacteria obtained at pH 4, and the non-toxicity for *Kluyveromyces marxianus* CBS 5795 at neutral pH. Ethanol production kinetics were determined using batch cultures of *K. marxianus* and a medium containing 40 g/L of lactose. Cultures containing 50 mM formic acid gave an ethanol production yield ($Y_{\text{EtOH/S}}$) of 0.67 C-mol/C-mol and final ethanol concentration of 19.1 g/L with 90.8% of the initial lactose concentration consumed within 30 hours. Formic acid preserved whey at room temperature for a three-week period without negatively influencing the subsequent yeast fermentation.

This chapter was submitted for publication in *Process Biochemistry* de Glutz FN, Viscasillas C, von Stockar U, Holliger C, Marison IW. Stabilization of whey permeate to enable ethanol production by *Kluyveromyces marxianus*.

2. Introduction

Cheese whey is the yellowish liquid remaining after the precipitation of milk casein during cheese making and represents more than 90% of the milk volume [1]. Composed mainly of lactose, soluble proteins, lipids and mineral salts it also contains, due to the activity of microorganisms naturally present in whey, lactic and citric acid [1-5]. Proteins from whey have a high nutritional value and are often collected by ultrafiltration (UF). The residual protein-free material is termed whey permeate [4].

The Swiss industry generates more than 4000 million tonnes of milk per year, of which a third is dedicated to cheese production [6]. The large volumes of whey produced cannot be simply discarded because of the high organic matter content, and thus represent an important environmental problem, as the 5-day biological oxygen demand (BOD₅) of whey is 30'000-50'000 g/m³ [1, 7-9]. Reduction of the BOD₅ to acceptable levels would require very expensive treatments. For this reason cheese manufacturers have explored the possibilities of valorization of whey. Generally proteins are first separated by ultrafiltration, dried and sold as food and feed supplements. Subsequently, a reverse osmosis process (RO) is often used to concentrate the resulting whey permeate to 12 % dry matter (DM) and used in the food industry (ice creams, cakes, and milk derivatives), baby food, dietetic products and certain alcohol-free beverages such as Rivella. However, use is limited due to the “salty” taste and lactose intolerance of large parts of the human population [7, 10]. Thus, these applications represent only a small part of the total production and whey permeate is mainly returned to farmers as animal feedstock in particular for the small cheese manufacturers [9, 11]. However, lactose intolerance of farm animals also limits the extensive use of whey in feed [12]. Whey permeate disposal is therefore a real problem for many small producers who cannot find an application for their production and thus have to assume expensive treatment/disposal costs. Nowadays, there are increasing efforts to reduce greenhouse gas emissions by the use of sustainable and renewable biofuels. Transformed into ETBE (Ethyl-tertio-buthyl-ether) or mixed with petrol or gasoline, bioethanol is being increasingly considered as a biofuel, particularly as a carburant, since it is considered to be CO₂ neutral, allows the maintenance of agricultural activities and a certain independency on fuel imports [11]. In addition, bioethanol can be formed from a wide range of crop surpluses and industrial waste products, such as whey permeate (Chapter 1). Ireland, USA and New Zealand are already producing bioethanol from whey permeate since they have large centralized dairy industries which enable bioethanol production plants to be directly associated [7]. In Switzerland more

than 1500 dairies of various sizes produce whey permeate throughout the country [5]. This wide distribution results in the need for transportation of whey to regional bioethanol plants together with storage. Since whey is a naturally very unstable, biologically degradable material, successful economic utilization of whey to produce bioethanol requires methods to conserve whey. Whey and whey permeate are unstable substrates because of microbial activity naturally present in whey and cheese industries, with concentrated whey retentate (12% DM) reported to be stable for only 2-3 days at 4°C [13]. The instability is mainly the result of growth of the bacterial flora causing conversion of lactose to lactic acid resulting in a reduction of pH and bioethanol production yield.

Considerable literature exists which report the difficulties in storing whey efficiently together with attempts to stabilize [13, 14]. In most cases, addition of preservatives was not efficient over long periods and the preservatives had subsequently to be removed enzymatically prior to alcoholic fermentation. Thus hydrogen peroxide was shown to be capable of stabilizing fresh whey for a period of ten-days [13] while a patent describes whey preservation using benzoic acid combined with reduction of the pH within about the range 3.0- 4.2 [15]. In the latter case the preserved whey was subsequently used as animal feed and no work was presented as to the applicability for yeast fermentation applications [15]. A combination of acidification, sugar concentration and potassium sorbate has been reported to protect whey [16] but once again without further application to fermentation. Hydrogen peroxide, propionic acid and formic acid have been used to control yeast contamination of whey, with formic acid shown to be highly effective over a four-day period [17]. Currently the only approved method of raw milk preservation, apart from refrigeration, is the lactoperoxidase system [18]. This method is applicable for milk products used for human consumption by inhibiting bacterial metabolism. Since it also inhibits yeast metabolism, it would require removal or inactivation prior to any subsequent ethanolic fermentation. Heat sterilization is a possibility, but would result in the loss of heat labile components including lactose, because of the Maillard reaction, peptides, vitamins and trace compounds. Pasteurization would be unsuitable for medium to long term preservation since it would still require refrigerated transport and storage conditions. Consequently the ideal preservation agent for whey, when it is to be used in bioethanol production, should prevent bacterial growth, be non-toxic for yeasts and should be cheap and efficient in low concentrations. In particular, it should not be necessary to remove the preservative prior to the ethanol production process. The present paper describes a simple and efficient method for preserving whey permeate over a three-week period at ambient temperature in order to use it subsequently for ethanol production.

3. Materials and Methods

3.1 Microorganisms, inocula preparation, media and preservative agents

The lactic acid bacteria, used as a positive control of the preservative activity, were isolated from a local cheese factory. The yeast *Kluyveromyces marxianus*, strain CBS 5795 (CBS, Utrecht, Netherlands), was used for assessment of the resistance to the preservatives and characterization of ethanol production. Stock cultures were stored as a suspension in 9 g/L NaCl and 10 g/L glycerol at -80°C. Cells were re-activated in a 1-liter baffled shake-flask containing 100 mL YPG medium at 30°C for 24h. Two cultures in baffled shake-flasks of 100 mL each were used to prepare the inocula. After 24 h at 30°C, the two pre-cultures were centrifuged at 4°C (10 minutes at 1500 g) and the cell pellets resuspended in 10 mL sterile water and used immediately. YPG medium contained 40 g/L glucose, 6 g/L yeast extract (Oxoid, Hampshire, England) and 5 g/L Bacto™Peptone (Becton, Le Pont de Claix, France) and was sterilized at 121°C for 20 min.

Since whey permeate is a non-defined medium of variable composition, all experimental bioreactor cultures were carried out using a chemically-defined medium [19]. The medium contained: 42.1 g/L of lactose monohydrate, 14.8 g/L of (NH₄)₂SO₄, 3 g/L of KH₂PO₄, 0.5 g/L of MgSO₄ · 7 H₂O, 10 mg/L of CaCl₂ · 2 H₂O, 2.67 mg/L of H₃BO₃, 0.8 mg/L of CuSO₄ · 5 H₂O, 0.27 mg/L of KI, 2.67 mg/L of MnCl₂, 1.07 mg/L of Na₂MoO₂ · 2 H₂O, 12 mg/L of ZnSO₄ · 7 H₂O, 40 mg/L of EDTA, 0.8 mg/L of CoCl₂, 8 mg/L of FeSO₄ · 7 H₂O, 2.67 mg/L of calcium pantothenate, 0.13 mg/L of biotin, 66.67 mg/L of m-inositol, 2.67 mg/L of nicotinic acid, 0.53 mg/L of para-amino benzoic acid (PABA), 2.67 mg/L of pyridoxine hydrochloride and 2.67 mg/L of thiamine hydrochloride.

All components were dissolved in ultrapure water (Elgastat UHP, O.Kleiner AG, Switzerland) and sterilized by filtration (0.22 µm, Steriltop, Millipore Corporation, Billerica, USA). Sterile antifoam agent (Structol J647; Schill+Seilacher, Germany), 1 mL/L was added to the sterile medium immediately prior to inoculation.

Cell density was determined spectrophotometrically by measuring optical density at 600 nm (OD₆₀₀). Viability was determined by counting colony-forming-units (CFU) after plating 100 µL of samples on solid medium (Plate-Count Agar, Merck, Germany) and incubating at 37°C for 48h.

Ultrafiltrated (UF) whey permeate (4% dry matter DM, 34.1 g/L of lactose), and reverse osmosis treated (RO) whey concentrate (12% DM, 106.7 g/L of lactose) were kindly supplied by Cremo AG (Villars-sur-Glâne, FR, Switzerland). Whey permeate was pasteurized at 65°C for 30 min and quickly cooled to 20°C before use.

The preservative agents tested were: acetaldehyde (Fluka, Germany), acetic acid (Acros, Germany), calcium propionate (Fluka, Germany), 30% hydrogen peroxide (Fluka, Germany), formic acid (Fluka, Germany), 37% formaldehyde (Sigma Aldrich AG, Germany) and propionic acid (Fluka, Germany).

3.2 Culture conditions

Shake-flask cultures were performed by adding 50 mL of UF or RO whey concentrate in the presence and absence of preservatives in 100 mL screw-capped flasks at 25°C, followed by inoculation with lactic acid bacteria to an initial cell density of 4×10^7 cells/L, and agitation on a rotary shaker at 100 rpm for five days.

Hydrolyzed lactose experiments were performed using a yeast extract (6 g/L) - peptone (5 g/L) medium to which 20 g/L glucose and 20 g/L galactose were added.

Ethanol production was undertaken using a 2-L bioreactor (1.5 L working volume, Bio-Engineering AG, Wald, Switzerland) operating at an agitation rate of 500 rpm. Temperature was maintained at 37°C and pH at 6.0 by automatic addition of 3M NaOH. A polarographic pO₂ probe (InPro 6800, Mettler Toledo, Greifensee, Switzerland) was used to monitor dissolved oxygen, with respect to air saturated medium. pO₂ was maintained below 3% by gassing with nitrogen in order to ensure anaerobic conditions.

3.3 Reagents and metabolite analysis

Lactose, acetaldehyde, acetic acid, calcium propionate, formic acid, formaldehyde, propionic acid, lactic acid and ethanol concentrations were determined by HPLC analysis (1100 series, Agilent Technologies, Palo Alto, USA). An ion exchange chromatography column (Supelcogel H, 30 cm x 4.6 mm; 9µm, Supelco, Bellefonte, USA) was used at 60°C. A 0.005 M H₂SO₄ solution in ultrapure water was applied at a constant eluent flow rate of 0.6 mL/min. Metabolites were measured using a refractive index detector.

3.4 Hydrogen peroxide titration

Hydrogen peroxide (H_2O_2) was measured by a new technique based on the xylenol orange complex method [20]. While standard methods can only measure H_2O_2 concentrations below $50 \mu\text{M}$ this method also enabled quantification at 2000-fold higher concentrations (100 mM) [21, 22].

Pure Xylenol orange tetrasodium salt (Merck, Germany) was used to prepare a 15 mM xylenol orange standard solution; ammonium iron(II) sulphate, $(\text{NH}_4)_2\text{Fe}(\text{SO}_4)_2 \cdot 6\text{H}_2\text{O}$ (Merck, Germany) was used to prepare a 15 mM Fe^{2+} solution; sulphuric acid 95-97% (Fluka, Germany) was used to prepare a solution of H_2SO_4 25 mM. Hydrogen peroxide 35% (Fluka, Germany) was used to prepare standard solutions. All compounds were dissolved in $0.20 \mu\text{m}$ filtered ultrapure water. The reagent solution was prepared by combining 98 mL of 25 mM H_2SO_4 solution with 1 mL of 15 mM xylenol orange solution and 1 mL of 15 mM Fe^{2+} solution. $5 \mu\text{L}$ of culture samples were added to 10 mL of reagent solution in a 15 mL screw-cap plastic bottle. After incubation at room temperature for 30 min, $100 \mu\text{L}$ of this solution were introduced into a 96-well PS micro plate and the absorbance measured spectrophotometrically at 560 nm against the reagent solution as reference. H_2O_2 concentration was determined from a standard calibration curve of absorbance at 560 nm versus H_2O_2 concentration. Since iron is oxidized very quickly in the presence of oxygen, the Fe^{2+} solution had to be prepared immediately prior to use and necessitated a new calibration curve for each experiment. Calibration curves were prepared using H_2O_2 standard solutions of the following concentrations: 4, 8, 16, 32, 64 and 97 mM (Figure 1).

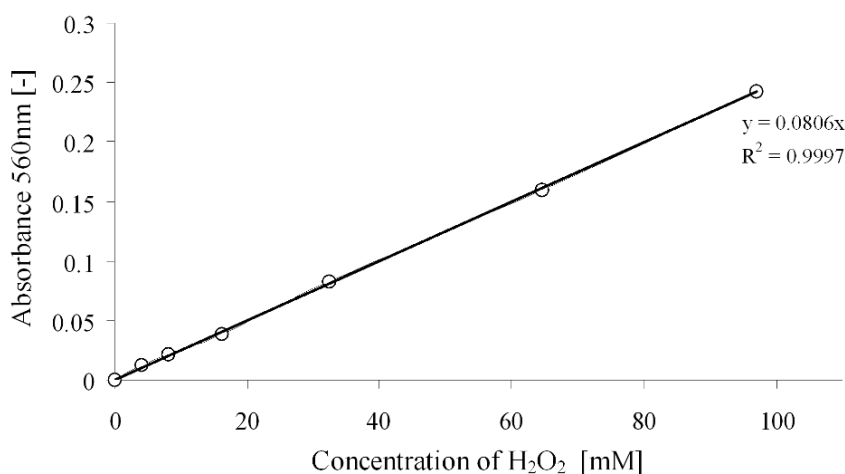

Figure 1. Calibration curve of modified ferric-xylenol orange complex method for determination of hydrogen peroxide (H_2O_2).

4. Results and Discussion

4.1 Screening of methods for whey permeate preservation

The seven preservative agents, acetaldehyde, acetic acid, calcium propionate, hydrogen peroxide, formic acid, formaldehyde and propionic acid, were screened for their efficiency in inhibiting bacterial growth in UF and RO whey permeate. While the preservative efficiency of hydrogen peroxide, formic acid and propionic acid have been reported [17], acetaldehyde and acetic acid find application in fruit preservation [23], and calcium propionate is commonly used in bread and baked goods but also in cosmetics and pharmaceuticals [22].

Of the selected compounds no stabilizing effect was measured in the tested concentration range with calcium propionate and propionic acid (Table 1). Experiments with acetic acid demonstrated poor antimicrobial properties and would thus required too large quantities for using it at industrial-scale.

Aldehyde compounds were found to be the preservative required in the smallest amount for complete inhibition of bacterial growth in UF whey permeate under the conditions studied (Table 1). However, formaldehyde at levels above 9 mM and acetaldehyde at levels above 35 mM, completely inhibited growth of *K. marxianus* and thus would have to be removed prior to fermentation enzymatically, which would result in a significant cost to the process.

A common physical method used in food industry to restrict microbial growth, is to reduce the water activity (a_w). This is often achieved through addition of high levels of sugars (40-70%). In the case of whey the principle sugar is lactose, which has a limited solubility and crystallizes at concentrations >24%, thus concentrating whey and whey permeate to reduce a_w has limited potential for whey stabilization. On the other hand it might be expected that, since hydrolysis of lactose yields glucose and galactose, both of which are highly soluble in water and do not readily crystallize, pre-treatment of the whey followed by concentration could be used to stabilize whey. However, in the present study, no reduction in the rate of bacterial growth was observed with either whey retentate concentrated to 205 g/L (600 mM) or hydrolyzed whey concentrated to 547 g/L (1.6 M) sugars (Table 1).

Another method reported for whey preservation is to add sodium benzoate while simultaneously lowering the pH [15]. However, in the present study, under the conditions

employed, no stabilization of the whey or reduction in the concentration of bacterial flora was observed over the pH range 3.0-7.0 (Table 1). This is not surprising considering that lactic acid bacteria are relatively resistant to low pH [24]. Furthermore the reported stabilization effect [15] is almost certainly due to benzoate being predominantly in the protonated form at low pH.

From these results of the compounds tested (Table 1), hydrogen peroxide and formic acid were retained for further studies since simple and inexpensive methods have been described for removing them.

The whey used in bioethanol production, may be whole whey which has not been subjected to ultrafiltration, and consequently contains high concentrations of proteins. Such proteins may provide a certain degree of protection of the lactic acid bacteria with respect to the preservation agents. Under the conditions used in the present study inhibition of bacterial growth over 3-5 days through addition of preservative, was identical for both whole whey and whey permeate (results not shown).

Table 1. Bacterial cell numbers in ultra-filtrated whey permeate stabilized by seven preservative agents and operating conditions after three and five days.

Preservative agent	Concentration mM	CFU/mL	
		day 3	day 5
Acetaldehyde	20	∞	∞
	≥35	<200	<20
Hydrogen peroxide	15 to 50	0	∞
	≥65	0	<3
Formic acid	25 to 40	∞	∞
	53	0	0
Propionic acid	15 to 70	∞	∞
Acetic acid	15 to 130	∞	∞
	175	15	6
Formaldehyde	9	0	∞
	≥18	0	0
Calcium propionate	5 to 80	∞	∞
Lactose	150 to 600	∞	∞
Hydrolyzed lactose	300 to 1600	∞	∞
pH	3.0 - 7.0	∞	∞

∞ refers to too numerous colonies to be counted

4.2 Stabilization of whey permeate using formic acid and hydrogen peroxide

From the results obtained for the range of preservation agents and conditions tested, formic acid and hydrogen peroxide were selected and the relative efficiency (ability to reduce the growth of lactic acid bacteria) tested in UF-treated and RO-treated whey permeates at two different temperatures (25°C and 6°C) over a period of three weeks.

For whey permeate (UF-treated whey), 50 mM of formic acid tested were sufficient to reduce the initial bacterial concentration by a factor of 100 during the first two days at 25°C and subsequently to maintain this level of bacterial concentration (approximately 10² cells/mL) for the whole 21 day period of the experiment (Figure 2a). Increasing the formic acid concentration to 100 mM resulted in a 100-fold reduction in the bacterial concentration and complete stabilization (Figure 2a). In the case of hydrogen peroxide, 100 mM was the minimum concentration necessary to stabilize whey permeate (Figure 2b). These results are in agreement with these of Spara *et al.* [17], who studied the efficiency of 50 mM formic acid, 40 and 80 mM propionic acid and 20 mM hydrogen peroxide to inhibit bacterial growth over four days. These authors showed that 50 mM formic acid could prevent bacterial growth while hydrogen peroxide (20 mM) had no stabilizing effect.

Interestingly, when whey retentate, concentrated by reverse osmosis to a lactose concentration of 106.7 g/L was tested with the preservation agents, the results were significantly different from those obtained with the same compounds using non-concentrated whey permeate (34.1 g/L lactose). Thus, 150 mM formic acid was now required to achieve the same level of bactericidal action and stability as that obtained with 50 mM formic acid for non-concentrated whey permeate (Figure 2c). By contrast, no difference was observed for the stabilization of whey permeate and RO-treated retentate using hydrogen peroxide as preservative (Figure 2d). This difference may be due to the buffering capacity of the medium. Addition of formic acid to whey permeate resulted in a decrease of the pH from 6.7 to 4.0- 4.2, whereas with RO-concentrated whey retentate the pH decreased considerably less and reached a value of 5.0- 5.5. Since the pK_a of formic acid is 3.75, this suggests that the protonated form is more active in stabilizing retentate. Hydrogen peroxide is not affected in the same way since the antimicrobial activity is not pH-dependent.

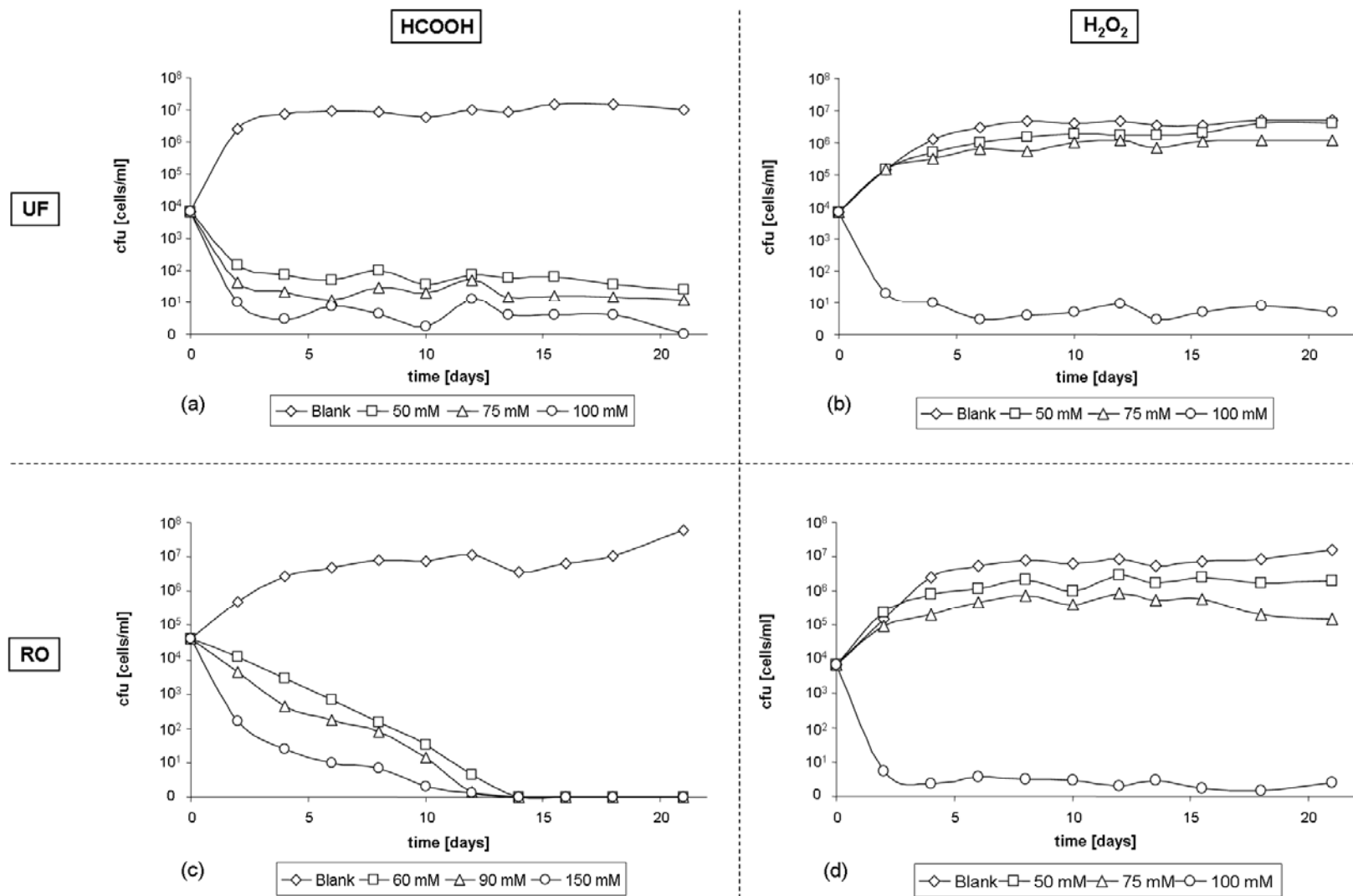

Figure 2. Bacterial cell numbers in (a) ultra-filtrated (UF) when permeate stabilized by formic acid at 25°C (b) UF when permeate stabilized by hydrogen peroxide at 25°C (c) reverse-osmosed (RO) treated when retentate stabilized by formic acid at 25°C (d) RO when retentate stabilized by hydrogen peroxide at 25°C. Cell density was measured as colony forming units after incubation on agar plate-count medium for 48h at 37°C.

Figures 2a-c also show the importance of stabilization of dilute and concentrated whey permeates, since at 25°C the bacterial concentration increased by 10^2 - 10^4 fold during the first two days of incubation. Similar experiments carried out at 6°C showed a reduced rate of bacterial growth, while the concentration of formic acid or hydrogen peroxide necessary to stabilize whey permeate and RO-concentrated whey retentate, remained unchanged. Since refrigeration of whey during storage and transport is extremely expensive, the ability to store at room temperature, providing sufficient preservative, greatly enhances the potential application of whey derivatives for bioethanol production.

The concentrations of the preservative agents were measured throughout the experiments and were shown to remain constant, thereby confirming that neither formic acid nor hydrogen peroxide was consumed during the three week duration of the experiments.

Since the aim of this work was to stabilize whey permeate such that it could be subsequently used for bioethanol production, it is essential to determine whether the preservatives inhibited the growth of *K. marxianus* CBS 5795, in which case they would need to be removed or broken down to inoffensive forms prior to the yeast fermentation. Batch cultures incubated in the presence of formic acid (50 mM) or hydrogen peroxide (100 mM) showed complete growth inhibition (Figure 3). This shows conclusively the requirement to remove the preservative from the whey permeate prior to bioethanol production. In the case of hydrogen peroxide it should be possible to break down through moderate heating, however, using the H_2O_2 developed here it was shown that even after heating to 85°C, significant inhibitory levels of H_2O_2 remained (Figure 3), which could only be removed through addition of catalase. On the other hand formic acid is believed to inhibit growth through its action on mitochondrial cytochrome oxidase, leading to a reduction in ATP synthesis whereas with the unprotonated form (formate) has no inhibitory effect [25, 26]. Thus it should be possible to remove the toxic effect of formic acid by raising the pH to 6.0, a value which is suitable for the growth of *K. marxianus* CBS 5795. Due to the simplicity of this procedure formic acid was selected for further testing as the preservative of choice for whey stabilization.

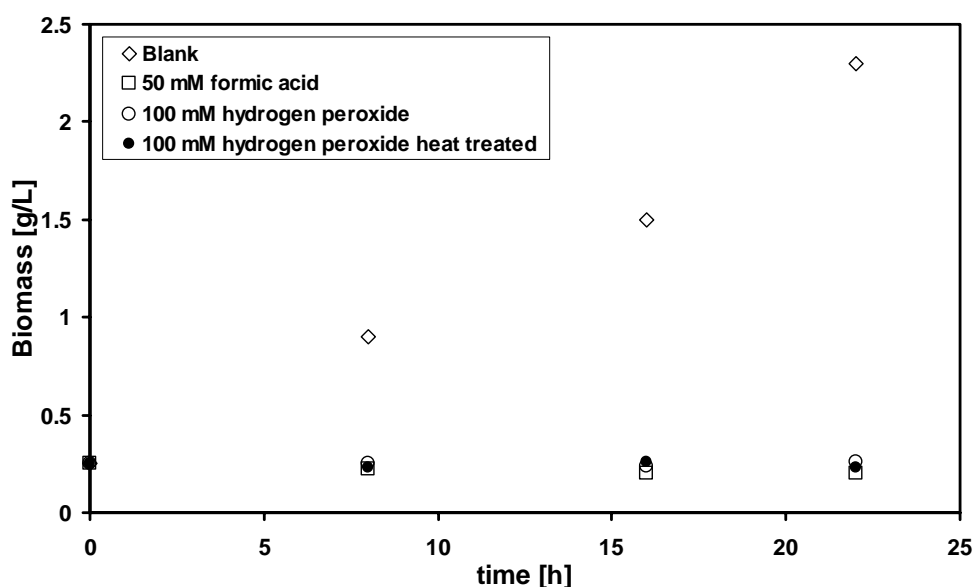

Figure 3. Growth of *K. marxianus* CBS 5795 in batch mode on ultra-filtrated whey permeate (◇) without preservative, (□) stabilized with 50 mM formic acid, (○) stabilized with 100 mM hydrogen peroxide and (●) stabilized with 100 mM hydrogen peroxide and heated at 85°C for 20 min prior to inoculation.

4.3 Ethanol production

Ethanol production was determined by comparing batch cultures of *K. marxianus* CBS 5795 grown on whey permeate in the presence and absence of 1.8 g/L (50 mM) formic acid.

In the absence of formic acid, over 91% of the initial lactose concentration (39.7 g/L) was consumed within 32 h at a maximum specific growth rate (μ_{\max}) of 0.055 h⁻¹. The biomass yield ($Y_{X/S}$) was determined to be 0.042 C-mol/C-mol (0.039 g/g), and a final ethanol concentration of 2.0 % (v/v) was obtained, corresponding to 16.4 g/L, and resulting in an ethanol yield ($Y_{\text{EtOH}/S}$) of 0.52 ± 0.03 C-mol/C-mol (0.42 ± 0.02 g/g).

By comparison, batch cultures of *K. marxianus* CBS 5795 on whey permeate containing 1.8 g/L formic acid resulted in 90.8 % of the initial lactose concentration (39.7 g/L) being consumed within 30 hours (Figure 4) at a maximum specific growth rate (μ_{\max}) of 0.047 h⁻¹. The biomass yield ($Y_{X/S}$) was 0.050 C-mol/C-mol (0.046 g/g) and a final ethanol concentration of 2.4 % (v/v) was obtained, corresponding to 19.1 g/L and resulting in an ethanol yield ($Y_{\text{EtOH}/S}$) of 0.67 ± 0.03 C-mol/C-mol (0.54 ± 0.02 g/g).

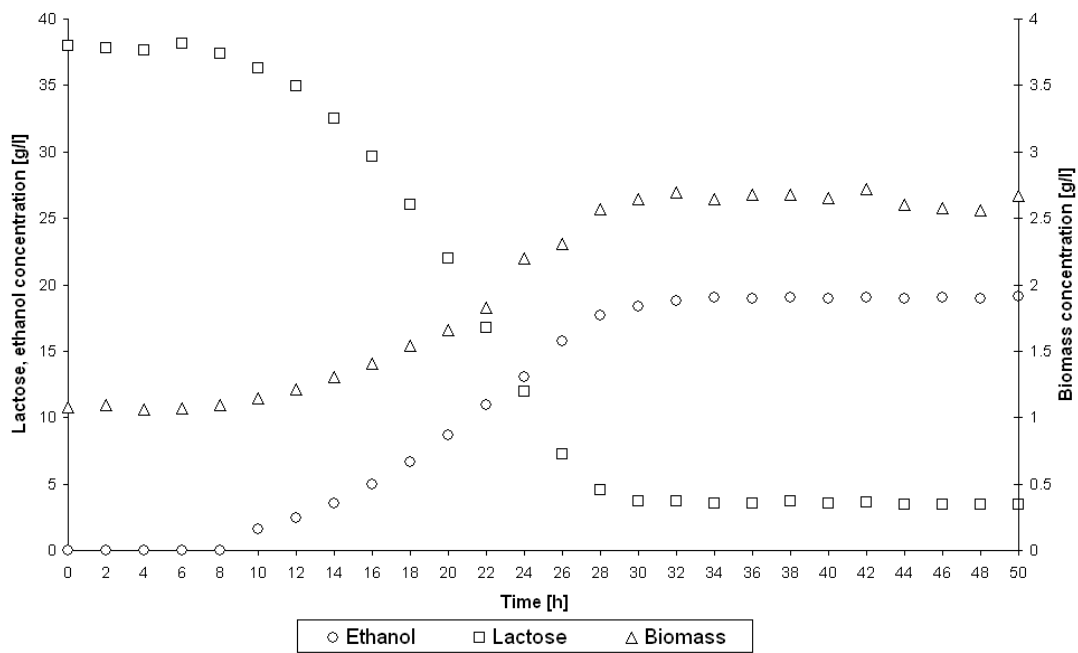

Figure 4. Kinetics of ethanol production from whey permeate containing 50 mM of formic acid with batch cultures of *K. marxianus* CBS 5795 at 37°C and pH 6.

These results compare very favorably with those reported for growth on spray-dried cheese-whey where the ethanol yield of *K. marxianus* DSMZ-7239 attained 0.54 g/g, although this was accompanied by a high growth yield, up to 1.2 g/g, which should result in sub-optimal ethanol production levels [9, 10].

The batch culture data show that the presence of formic acid had no negative effect on ethanol production, indeed the ethanol yield actually increased by 28%. An increase in ethanol yield, due to formic acid addition, has been reported for number of yeasts selected for wine production [27], thus it appears that formic acid is also capable of stimulating ethanol production from whey with *K. marxianus* CBS 5795.

5. Conclusions

Of the seven compounds, and a range of conditions, tested for their ability to stabilize and inhibit bacterial growth in whey permeate, hydrogen peroxide and formic acid were the most efficient in stabilizing whey permeate at 25°C over a period of three weeks. While a too complex procedure is needed to remove hydrogen peroxide from whey prior to ethanolic yeast fermentation, the fully dissociated form of formic acid was shown to be non-toxic for *K. marxianus* CBS 5795. Thus by simply adjusting the pH prior to inoculation, *K. marxianus* was able to produce ethanol at least as efficiently as in the absence of formic acid. Furthermore, a formic acid concentration of 50 mM even stimulated the ethanol yield possibly by serving as additional substrate resulting in mixed-substrate fermentation. These results open the possibility of transporting and storing highly unstable whey derivatives, such as permeate, at room temperature for periods of at least 3 weeks, by the simple addition of a cheap and innocuous substance, formic acid at low concentrations, followed by a straightforward adjustment of the pH immediately prior to yeast inoculation. Such a method should result in significantly improved process economics, since the use of whey permeate to produce ethanol is currently limited to large dairies, which must use permeate directly after production, or the whey and whey permeate must be dried to enable transportation and storage prior to fermentation at a distant site.

6. Nomenclature

ATP	Adenosine triphosphate	
BOD ₅	5-day biological oxygen demand	$\text{g}\cdot\text{m}^{-3}$
CFU	Colony forming units	$\text{cell}\cdot\text{L}^{-1}$
DM	Dry Matter content	
ETBE	Ethyl-tertio-buthyl-ether	
RO	Reverse osmosed	
UF	Ultrafiltrated	
X	Cell dry weight	$\text{g}\cdot\text{L}^{-1}$
$Y_{j/i}$	Yield coefficient of substance j on substance i	$\text{C}\cdot\text{mol}\cdot\text{C}\cdot\text{mol}^{-1}$
		$\text{g}\cdot\text{g}^{-1}$
YPG	Yeast extract-Peptide-Glucose rich medium	
μ	Maximum specific growth rate	h^{-1}

Subscripts

EtOH	Ethanol
i	Refers to compound i
j	Refers to compound j
max	Maximal
S	Refers to limiting nutrient
w	Water
X	Refers to the produced biomass

7. Acknowledgments

We particularly thank Mrs. Laure Stalder for kindly providing whey and whey permeate (Crema Ltd, Freiburg, Switzerland). This work was undertaken with financial support from Alcosuisse Ltd, Bern, Switzerland.

8. References

- [1] Siso MIG. The biotechnological of utilization of cheese whey: a review. *Bioresource Technology* 1996; 57: 1-11.
- [2] Domingues L, Lima N, Teixeira JA. Alcohol production from cheese whey permeate using genetically modified flocculent yeast cells. *Biotechnology and Bioengineering* 2001; 72: 507-514.
- [3] Silveira WB, Passos FJV, Mantovani HC, Passos FML. Ethanol production from cheese whey permeate by *Kluyveromyces marxianus* UFV-3: a flux analysis of oxidoreductive metabolism as a function of lactose concentration and oxygen levels. *Enzyme and Microbial Technology* 2005; 36: 930-936.
- [4] Zafar S, Owais M. Ethanol production from crude whey by *Kluyveromyces marxianus*. *Biochemical Engineering Journal* 2006; 27: 295-298.
- [5] Fiduciaire de l'économie laitière S.à.r.l., editor. Statistique laitière de la Suisse. Brougg: Secrétariat de l'Union Suisse des paysans; 2006.
- [6] Marwaha SS, Kennedy JF. Review: whey-pollution problem and potential utilization. *International Journal of Food Science & Technology* 1988; 23: 323-336.
- [7] Mawson AJ. Bioconversions for whey utilization and waste abatement. *Bioresource Technology* 1994; 47: 195-203.
- [8] Kemp DL, Quickenden J. Whey processing for profit - a worthy alternative. In: Greenshield R editors. *Resources and applications of biotechnology- the new wave*. Basingstoke: Macmillian; 1989. p. 323-331.
- [9] Kargi F, Ozmihci S. Utilization of cheese whey powder for ethanol fermentations: effects of operating conditions. *Enzyme and Microbial Technology* 2006; 38; 711-718.
- [10] Ozmihci S, Kargi F. Kinetics of batch ethanol fermentation of cheese-whey powder solution as function of substrate and yeast concentration. *Bioresource Technology* 2007; 98: 2978-2984.
- [11] von Stockar U, Marison IW. Unconventional utilization of whey in Switzerland. In: Ghose TK editors. *Bioprocess Engineering*. Oxford: IRS Press; 1989. p. 343-365.
- [12] Schingoethe DJ. Whey utilization in animal feeding: a summary and evaluation. *Journal of Dairy Science* 1976; 59(3): 556-570.
- [13] Jasewicz L, Porges N. Whey preservation by hydrogen peroxide. *Journal of Dairy Science* 1959; 42: 1119-1125.
- [14] Rao RD, Wendorff WL, Smith K. Changes in galactose and lactic acid content of sweet whey during storage. *Journal of Food Protection* 2004; 67(2): 403-406.
- [15] Sawhill JW. Preservation of whey. USA Patent 4081555. 06.09.1976.
- [16] De Kanterwicz RJ, Chirife J, Amato De Lagarde E. Preservation of concentrated cheese whey by combined factors. *Journal of Food Science* 1985; 50(6): 1629-1632.
- [17] Spara AF, Gutzwiller A, Gafner JL, Stoll P. Comparaison d'agents conservateurs pour les sous-produits laitiers. *Revue Suisse Agricole* 2003; 35(6): 283-287.
- [18] Hoffmann I. The lactoperoxidase system of raw milk preservation. In: Food and Agriculture Organization of the United Nations editors. *Call for data and expertise*. Rome: World Health Organization; 2005.

- [19] Verduyn C, Postma E, Sheffers WA, van Dijken JP. Effect of benzoic acid on metabolic fluxes in yeast: a continuous culture study on the regulation of respiration and alcoholic fermentation. *Yeast* 1992; 8: 501-517.
- [20] Gay C, Collins J, Gebicki JM. Determination of hydrogen peroxides by the ferric-xylenol orange method. *Analytical Biochemistry* 1999; 273: 143-148.
- [21] Banerjee D, Kumar PA, Madhusoodanan UK, Nayak S, Jacob J. Determination of absolute hydrogen peroxide concentration by spectrophotometric method. *Current Science* 2002; 83(10): 1193-1994.
- [22] Katsinis G, Rigas F, Doulia D. Synergistic effect of chemical preservatives with ethanol on the microbial shelf life of bread by factorial design. *International Journal of Food Science and Technology* 2008; 43(8): 208-215.
- [23] Simpson T, Bikoby V, Mitcham EJ. Effects of acetaldehyde on fruit quality and target pest mortality for harvested strawberries. *Postharvest Biology and Technology* 2003; 28(3): 405-416.
- [24] Brink M, Todorov SD, Martin JH, Senekal M, Dicks LMT. The effect of prebiotics on production of antimicrobial compounds, resistance to growth at low pH and in the presence of bile, and adhesion of probiotic cells to intestinal mucus. *Journal of Applied Microbiology* 2006; 4: 813-820.
- [25] Mahieu P. Le méthanol. In: Société de Toxicologie Clinique. Mise au point sur la toxicité des pyréthriinoïdes. Dublin: Bulletin Infotox n°8; 1999.
- [26] Keyhani J, Keyhani E. EPR study of the effect of formate on cytochrome C oxidase. *Biochemistry and Biophysics Resource Community* 1980; 92(1): 327-333
- [27] Schuller D, Corte-Real M, Leao CA. A differential medium for the enumeration of the spoilage yeast *Zygosaccharomyces bailii* in wine. *Journal of Food Protection* 2000; 63(11): 1570-1575.

Chapter 4

Enhancement of ethanol
productivity by controlling
pre-culture conditions

1. Abstract

Global productivity of a fermentation unit operation can be considerably reduced as a result of a long non-productive lag phase or by a slow initial growth rate. In order to improve the understanding of the principle parameters which influence the duration of the lag phase, six pre-culture parameters were tested alone or in combination on two ethanol-producing yeasts, *Kluyveromyces marxianus* CBS 5795 and CBS 397, using whey permeate as substrate through the application of design of experiment procedures. The key parameters identified through this strategy were influence of temperature, type of sugar, culture mode, initial biomass concentration and initial sugar concentration. Careful selection and control of these parameters enabled reducing the lag phase from 154 minutes to zero, while positively influencing growth rate. The conditions for the production of the culture inocula, during the pre-culture phase, were subsequently integrated into the process design. Optimum ethanol productivity was achieved by cultivating the pre-culture anaerobically on 100 g/L lactose medium. The other studied parameters showed less importance in influencing ethanol productivity.

This chapter was submitted for publication in *Process Biochemistry*
de Glutz FN, Holliger C, Marison IW. Enhancement of ethanol productivity by controlling pre-culture conditions.

2. Introduction

The productivity of a single unit operation is given by the quantity of product obtained per unit time [1]. For bioprocesses, unrealistically high productivities are frequently reported since they often do not take into account the down time from preparation of reactor through to harvesting. Of the reports, Ghaly and El-Toweel [2] provided details of the different phases of batch growth, including the lag phase. For the conversion of 100 g/L whey permeate to ethanol by using *Kluyveromyces fragilis* ATCC 8619. In this work they reported a lag phase of 19.5h for a total culture duration of 68h, which reduced the overall system productivity by over 15% [2]. In another case, the duration of the lag phase was as long as that of the ethanol production period. This occurred for the fermentation of 100 g/L whey permeate with *Kluyveromyces marxianus* NRRL-1195. In this study total sugar consumption was achieved after 96 hours of which more than 48h represented the down time [3]. While these examples represent extreme cases that illustrate how important it is to reduce the initial lag phase, more common values of 4 to 10 hours have been observed, which still represents a loss of productivity of 10% to 30% during the ethanol production phase [4-6]. In chapter 3, when fermenting 40 g/L whey permeate in batch cultures with *K. marxianus* CBS 5795, the lag phase represented 8 to 9 hours of an overall 32 hour fermentation, which represents an almost 30% reduction in productivity. Since the down time, required for filling, emptying and sterilizing the fermentation vessel, is relatively constant, it is vitally important to reduce the lag phase during which the microorganisms adapt to the new growth and production conditions.

Batch fermentation operation generally ends when the main carbon and energy source has been consumed and the culture enters the stationary phase of the process. While it is commonly admitted that certain parameters, such as temperature, aeration rate or the carbon source are parameters, may influence the lag phase period [7], no clear assessment has been made with respect to the yeasts currently employed in bioethanol production from whey. Key questions such as: (i) what is the real effect of the single parameters on the reduction or the extension of the lag phase period? (ii) do these parameters present interactions of second or third level between each other? and finally, (iii) what are the key parameters for reducing the lag phase? These are the questions this study aims to answer. In general, the growth history of the yeast is responsible for variations in the lag phase due to choice of inappropriate conditions, age of pre-culture and significant changes between the conditions of the

production culture compared with the pre-culture [8-11]. Thus it is important to optimize the conditions in the pre-culture. This has been achieved by studying the impact of five pre-culture parameters on ethanol production from whey permeate. These parameters were: temperature, type of sugar, pre-culture mode, initial sugar concentration and initial biomass concentration. Applicability of the results to a range of similar organisms has been verified by comparing two ethanol producing yeasts: *K. marxianus* CBS 5795 and another lactose-fermenting yeast, *K. marxianus* CBS 397 [12].

Identification of the effects of single parameters is relatively straight forward; however a precise strategy must be developed if the aim is to characterize all of the cross-interactions between these parameters. A design of experiment (DOE) strategy facilitates the choice of an experimental set of experiments, suitable for achieving the desired goals and will be described in more detail.

2.1 Design of experiment methodology

The conclusions that are obtained from a series of experiments depend on the care with which the experimental strategy is made, keeping in mind how the results will be analyzed. Too often the focus is on technical aspects concerning the way measurements will be performed, while a check at the experiments to see whether they allow the interpretation level expected is often forgotten. As a result, the procedure often ends in very poor information. The methodology of experimental design aims to choose the strategy carefully and then gives an important place to the planning of the experiments.

The most usual design used, unfortunately, consists in varying one factor at a time (OFAT). This way of doing things has the drawback of not taking into account interactions between factors. For this aspect, alone factorial design brings a major improvement to the experimental strategy. The advantage of factorial design compared to the OFAT design lies in varying all the factors simultaneously but in a structured way. This technique allows getting results of a better quality because the system transfers less experimental variance, each parameter being tested as many times as possible. A second advantage is the width of the experimental surface covered by the measurements. In the example with two parameters tested at two levels, this area is two-fold higher with factorial design (Figure1b), compared to OFAT design (Figure1a).

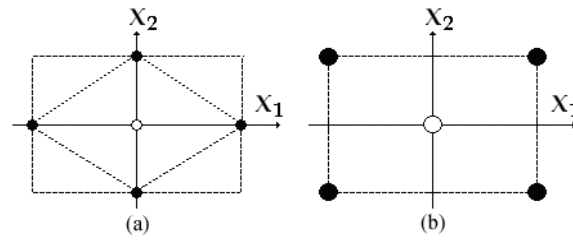

Figure 1. Comparison of the experimental surface covered by (a) the “one factor at a time” method and (b) the corresponding design of experiment model.

For ensuring a total comprehension of the terminology that will be used further, some important concepts need to be defined. Thus, a response is the consequence of a phenomenon; a factor is a parameter which has an influence on the studied phenomenon; the levels are the values a factor can take; the matrix of experiments is the matrix of N lines and k columns whose elements x_{ij} correspond to the level of the factor j in the experiments I; the matrix of the model is the matrix X which has one line per experiment, one column per coefficient of the model such as:

$$y = a_0 + \sum_{i=1}^N a_i x_j + \sum_{i,j \neq 1}^N a_{ij} x_i x_j + e_i \quad (1)$$

Several possibilities exist to represent a factorial design. Usually the indices used are “-1” and “+1”, which have the advantage of creating a transitive group with the operation multiplication of column. The state of the system is then fully determined by a vector of state containing the indices of each factor and, for each factor, the real physical values corresponding to the indices.

The matrix of the model X is constructed from the matrix of experiments E. The matrix of the model has the same number of columns as the number of coefficients of the model. The column corresponding to the interaction $x_i x_j$, which is used to calculate the coefficient a_{ij} , is the product of the columns i and j of the matrix of experiments. The product of two columns is a column with the same number of elements as the multiplied columns and whose elements are the products two by two of the original elements as showed in Equation 2:

$$\begin{bmatrix} a_1 \\ \vdots \\ a_N \end{bmatrix} \begin{bmatrix} b_1 \\ \vdots \\ b_N \end{bmatrix} = \begin{bmatrix} a_1 b_1 \\ \vdots \\ a_N b_N \end{bmatrix} \quad (2)$$

For the factorial designs, the number of coefficients (and of experiments) grows exponentially with the number of factors. For this reason, the plans can rapidly become too costly and unusable.

Fractional designs are of major importance because they avoid this exponential expansion by dividing the number of experiments by a factor 2, 4, 8, etc... As the system is no longer “complete” the concept of resolution appears. The resolution R is then an important concept for selecting a fractional design. It describes the type of alias by the reduction of the full factorial design. The resolution thus indicates which levels of interaction two responses can or not be distinguished from one another. A table of resolution and generators is presented in Table 1.

Table 1. Table of available factorial design and resolution [13].

	3 ^a	4	5	6	7	8	9	10	11
4 ^b	2 ^{3-1c} _{III^d} ±3=12 ^c								
8	2 ³	2 ⁴⁻¹ _{IV}	2 ⁵⁻² _{III}	2 ⁶⁻³ _{III} ±4=12 ±5=13 ±6=23	2 ⁷⁻⁴ _{III} ±4=12 ±5=13 ±6=23 ±7=123				
16	2 ³ 2 times	2 ⁴	2 ⁵⁻¹ _V ±5=1234	2 ⁶⁻² _{IV} ±5=123 ±6=234	2 ⁷⁻³ _{IV} ±5=123 ±6=234 ±7=134	2 ⁸⁻⁴ _{IV} ±5=234 ±6=134 ±7=123 ±8=124	2 ⁹⁻⁵ _{III} ±5=123 ±6=234 ±7=134 ±8=124 ±9=1234	2 ¹⁰⁻⁶ _{III} ±5=123 ±6=234 ±7=134 ±8=124 ±9=1234 ±10=12	2 ¹¹⁻⁷ _{III} ±5=123 ±6=234 ±7=134 ±8=124 ±9=1234 ±10=12 ±11=13
32	2 ³ 4 times	2 ⁴ 2 times	2 ⁵	2 ⁶⁻¹ _{VI} ±6=12345	2 ⁷⁻² _{IV} ±6=1234 ±7=1245	2 ⁸⁻³ _{IV} ±6=123 ±7=134 ±8=2345	2 ⁹⁻⁴ _{IV} ±6=2345 ±7=1345 ±8=1245 ±9=1345 ±10=2345	2 ¹⁰⁻⁵ _{IV} ±6=1234 ±7=1235 ±8=1245 ±9=1345 ±10=2345	2 ¹¹⁻⁶ _{IV} ±6=123 ±7=234 ±8=345 ±9=134 ±10=145 ±11=245
64	2 ³ 8 times	2 ⁴ 4 times	2 ⁵ 2 times	2 ⁶	2 ⁷⁻¹ _{VII} ±7=123456	2 ⁸⁻² _V ±7=1234 ±8=1256	2 ⁹⁻³ _{IV} ±7=1234 ±8=1256 ±9=3456	2 ¹⁰⁻⁴ _{IV} ±7=2346 ±8=1346 ±9=1245 ±10=1235	2 ¹¹⁻⁵ _{IV} ±7=345 ±8=1234 ±9=126 ±10=2456 ±11=1356
128	2 ³ 16 times	2 ⁴ 8 times	2 ⁵ 4 times	2 ⁶ 2 times	2 ⁷	2 ⁸⁻¹ _{VIII} ±3=1234567	2 ⁸⁻² _{VI} ±8=13467 ±9=23567	2 ¹⁰⁻³ _V ±8=1237 ±9=2345 ±10=1346	2 ¹¹⁻⁴ _V ±8=1237 ±9=2345 ±10=1346 ±11=1234567

^a number of screened factors

^b number of required experiments for DOE interpretation

^c partial factorial design obtained by reducing full factorial by a defined number of factors

^d resolution of the factorial design

^e generator which needs to be used for obtaining an orthogonal matrix. The number of generators depends of the degree of system simplification. Here, the third column of the matrix is generated by the product of columns 1 and 2.

Normal plot

A normal plot is a technique that allows making an error analysis when there are no replications of factorial design, so no available degree of freedom. In this case the system is said to be orthogonal by making an analysis of variance. In a normal distribution (Figure 2a), the probability that a value smaller than x occurs is proportional to the darkened surface P . If $P(x)$ is reported graphically as a function of x , a cumulative distribution function is obtained called a sigmoid. The normal plot is obtained by adjusting the vertical axis as shown in Figure 2c, in such a way that the curve of $P(x)$ is a straight line. This technique is used for selecting the significant effects and to test the residual errors. Interpretation is the following: if the effects are normally distributed, there is a presumption that they proceed from a random process and that they are caused by the experimental noise. In this case the effects, which are aligned on a straight line, are disqualified. As a consequence the significant effects will not be aligned with the “noise” line. A normal plot compares the mean value with one of the extrema which leads to a half-effect, in which the effect of changing from the “-1” to the “+1” state is obtained by doubling the results of the normal plot analysis.

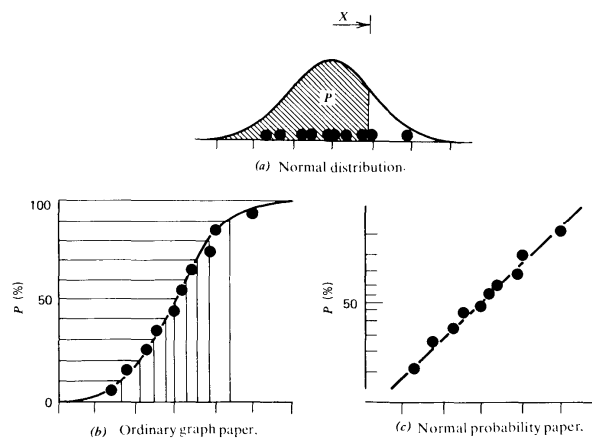

Figure 2. Interpretation of normal plot method for identifying the significant effects. (a) Experimental data; (b) normalization of experimental data; (c) Fisher transform of normalized data. Significant factor is not aligned with linear randomly distributed effects.

Analysis of Variance (ANOVA)

The experimental data vector Y is decomposed into orthogonal components. The mean vector is perpendicular to the effect vector and also with the residual vector. Using Pythagoras theorem, the sum of the squares of the data is equal to the sum of the squares of the components. The analysis of variance consists in comparing the size of the model vector with the size of the residual vector.

3. Materials and Methods

3.1 Microorganisms and culture conditions

The yeasts *K. marxianus*, CBS 5795 and CBS 397 (CBS, Utrecht, Netherlands), are able to use glucose and lactose as sole carbon and energy source. They are Crabtree negative facultative anaerobes which produce ethanol as the primary product of fermentative metabolism. Cultures were carried out in 500 mL screw-capped bottles housing a stopper, containing a hermetic septum to facilitate sterile sampling. The bottles were placed on a rotary shaker, set to provide a constant agitation rate of 200 rpm and a temperature of 37°C. The pH of the culture medium was adjusted 6.0 by addition of 3M NaOH and the dissolved oxygen concentration was set to 1% with respect to air saturation by addition of nitrogen prior to inoculation. The initial cell density after inoculation was fixed to 1 g biomass/L culture medium.

3.2 Analytical methods and pre-culture media

Cell density was determined spectrophotometrically by measurement of optical density at 600 nm (OD₆₀₀). The culture medium was whey permeate powder (Cremo, Villars-sur-Glâne, Switzerland) reconstituted to 40 g/L and pasteurized at 65°C for 30 min, then quickly cooled to 37°C just before the beginning of the experiment. Stock cultures were stored as a suspension in 9 g/L NaCl and 10 g/L glycerol at -80°C. Cells were re-activated in shake-flasks containing 200 mL of a rich pre-culture medium for 24h, the composition of which depended on the experimental plan. Anaerobic pre-culture experiments were performed in 250 mL Erlenmeyers while aerobic pre-culture experiments were carried out in 500 mL baffled shake-flasks, both of which were stirred at 200 rpm. The pre-culture medium contained 6 g/L yeast extract (Oxoid, Hampshire, England) and 5 g/L Bacto™Peptone (Becton, Le Pont de Claix, France). Depending on the experimental plan either glucose or lactose was used in the following concentrations: 20 g/L lactose, 20 g/L glucose, 100 g/L lactose and 100 g/L glucose. All components were dissolved in ultrapure water and sterilized by filtration (0.22 µm, Steriltop, Millipore Corporation, Billerica, USA). After 24 hours, the pre-cultures were centrifuged at 4°C (10 minutes at 1500 g) and the cell pellets resuspended in 10 mL sterile water and used immediately to inoculate whey permeate in culture experiments.

4. Results and discussion

4.1 Experimental parameters

The first step in the DOE methodology was to choose the optimum experimental plan in order to be able to interpret the effect of screened factors at the desired interpretation level. The factors studied, and their corresponding values, are reported in Table 2.

Since the six parameters might be strongly interdependent, the system needs to provide the highest resolution possible. A fractional plan of $2^{(6-1)}$ experiments (32) was therefore preferred to (i) full factorial (Table 1) for the reduction of experiments by a half and to (ii) a fractional plan of $2^{(6-2)}$ due to the 2-fold higher degree of resolution enabling the interpretation of third order interactions. Experimental conditions for the 32 experiments can be found in Table 3.

Table 2. Experimental factors with their corresponding levels and values.

Factor	Level	Value	Unit
(F1) Yeast Strain	-1	CBS 5795	
	1	CBS 397	
(F2) ¹ Initial biomass	-1	0.5	g·L ⁻¹
	1	2	g·L ⁻¹
(F3) ² Type of sugar	-1	glucose	
	1	lactose	
(F4) ² Culture mode	-1	aerobe	
	1	anaerobe	
(F5) ² Available sugar	-1	20	g·L ⁻¹
	1	100	g·L ⁻¹
(F6) ² Temperature	-1	25	°C
	1	37	°C

¹ in fermentation cultures

² in pre-cultures

Pre-culture conditions do not only influence the lag phase but also act on other parameters which are equally important to take into account when targeting maximal ethanol productivity. Three effects were thus studied with respect to an optimal strategy for production of bioethanol from whey permeate. These were the (1) lag phase period; (2) the growth rate (μ) in the fermentation experiments and (1) the biomass concentration produced after the pre-culture period. Each experiment was followed over a period of 12 h in order to provide enough data for establishing accurate growth curves.

Table 3. Matrix of experiments. Each row corresponds to an experiment, which factors (columns) take specific levels ensuring orthogonality of the matrix.

experiment	Operating factors					
	yeast strain	biomass concentration	type of sugar	culture mode	sugar concentration	temperature
	F1	F2	F3	F4	F5	F6
1	-1	-1	-1	-1	-1	-1
2	1	-1	-1	-1	-1	1
3	-1	1	-1	-1	-1	1
4	1	1	-1	-1	-1	-1
5	-1	-1	1	-1	-1	1
6	1	-1	1	-1	-1	-1
7	-1	1	1	-1	-1	-1
8	1	1	1	-1	-1	1
9	-1	-1	-1	1	-1	1
10	1	-1	-1	1	-1	-1
11	-1	1	-1	1	-1	-1
12	1	1	-1	1	-1	1
13	-1	-1	1	1	-1	-1
14	1	-1	1	1	-1	1
15	-1	1	1	1	-1	1
16	1	1	1	1	-1	-1
17	-1	-1	-1	-1	1	1
18	1	-1	-1	-1	1	-1
19	-1	1	-1	-1	1	-1
20	1	1	-1	-1	1	1
21	-1	-1	1	-1	1	-1
22	1	-1	1	-1	1	1
23	-1	1	1	-1	1	1
24	1	1	1	-1	1	-1
25	-1	-1	-1	1	1	-1
26	1	-1	-1	1	1	1
27	-1	1	-1	1	1	1
28	1	1	-1	1	1	-1
29	-1	-1	1	1	1	1
30	1	-1	1	1	1	-1
31	-1	1	1	1	1	-1
32	1	1	1	1	1	1

4.2 Lag phase

The difficulty in accurately determining the end of the lag phase of a batch culture resulted in the need for a rule which defined when the system entered into the exponential phase. Biomass concentration was determined by measurement of optical density and replicate experiments determined to a confidence interval of 0.02 absorbance units. The lag phase was considered to be over when two consecutive OD measurements increased by greater than 0.02 absorbance units. Figure 3 presents the values of the measured effects for the 32 experiments. The lag phase period varied considerably thereby showing the importance of pre-culture conditions. An average lag phase of 154 min was determined based on the 32 experiments. However, this value varied from 20 to 440 minutes depending on the experimental conditions. Due to the criteria used for determination of the end of the lag phase, 20 minutes was the resolution of the measurements, consequently a lag phase of 20 minutes is equivalent to no lag phase. Such long adaptation periods have been reported previously, with lag phases varying from 4 to 10 hours [4-6]. In chapter 3 with *K. marxianus* CBS 5795, when pre-cultures were performed aerobically with glucose as a carbon source, 9 hours of lag phase were observed and, using similar culture conditions as in this study, a lag phase of 430 min was measured. The published values are very similar to the range of values measured here. Linearization of the raw data (Figure 4) showed which factors were the most significant for reducing the lag phase. Relevant factors are identified if their effects were not linear with respect to random effects contained within the two dashed limits. To obtain the real improvement of a factor, the value of the abscissa must be multiplied by a factor of two.

Two main factors appear to influence the duration of the lag phase: the type of sugar (F3), which reduced the lag phase period by 130 min \pm 12 min when the pre-culture was performed on lactose, and the culture mode (F4), which reduced the lag phase period by 114 min \pm 10 min when the pre-culture was carried out anaerobically. Less significantly, the initial biomass concentration (F2) could be implied as well, the lag phase being shortened when high initial biomass is present. While the effect of first order factors were the most significant, combinations of factors also acted on the lag phase. Interaction of the type of sugar and the culture mode (F3F4) extended the lag phase period by 72 min \pm 7 min. This result means that the reduction on the lag phase, by a combination of these two factors, does not correspond to the sum of their individual contributions.

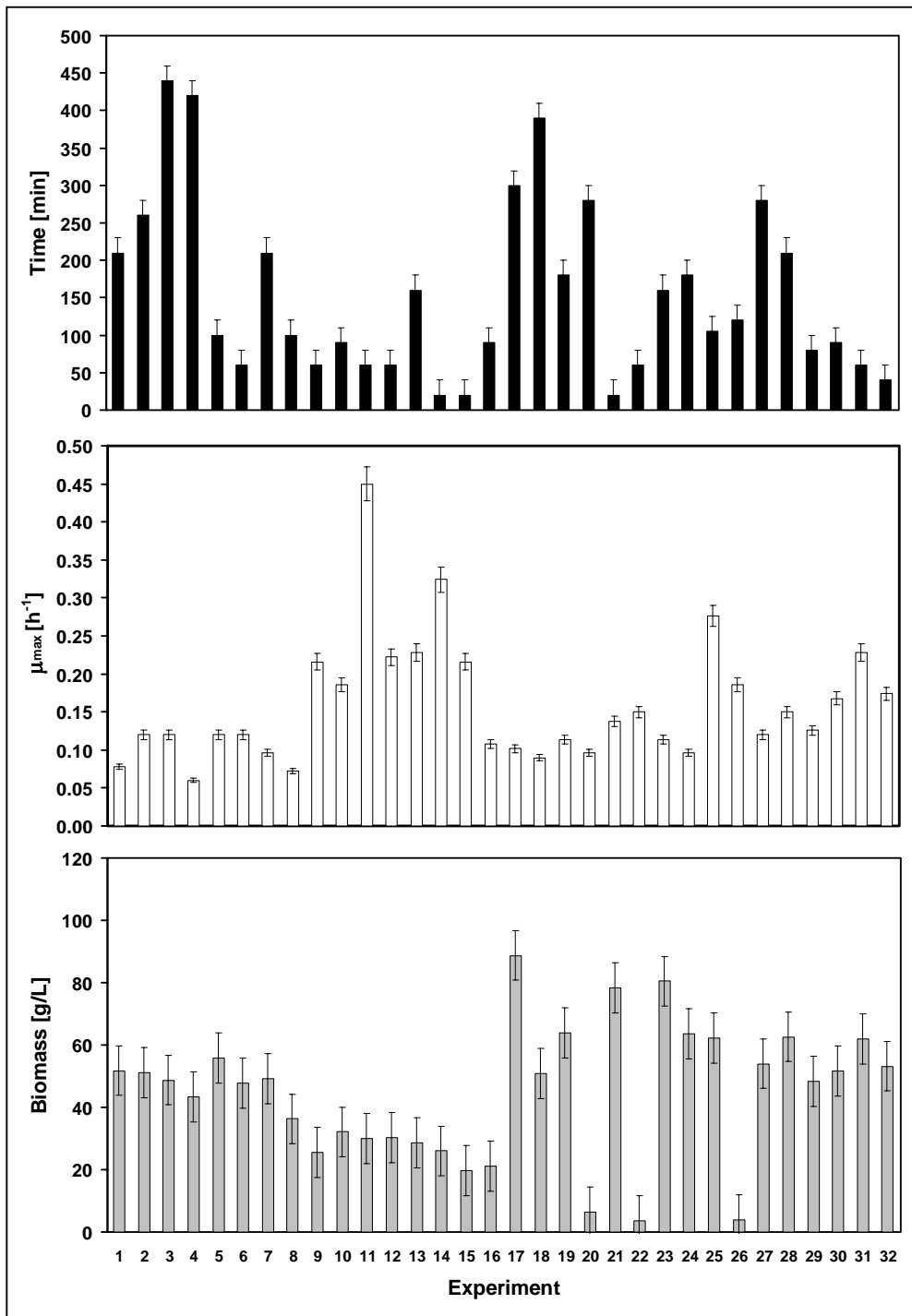

Figure 3. Effects measured for the selected experimental factorial design. (■) Lag phase period in fermentation experiments (min); (□) growth rate in fermentation experiments (h^{-1}); (■) biomass produced after 24 hours of pre-culture.

The average lag phase was measured to be 154 min but the sum of F3 and F4 effects represents 243 min \pm 22 min. This increase of lagphase period corresponds to this difference. The combination of temperature and yeast strain (F1F6) shows that *K. marxianus* CBS 397 was more sensitive to temperature than CBS 5795. Finally, the effect of the culture mode combined with the sugar concentration of the pre-culture (F4F5) suggests that anaerobic pre-cultures grown on low sugar concentrations would extend the lag phase.

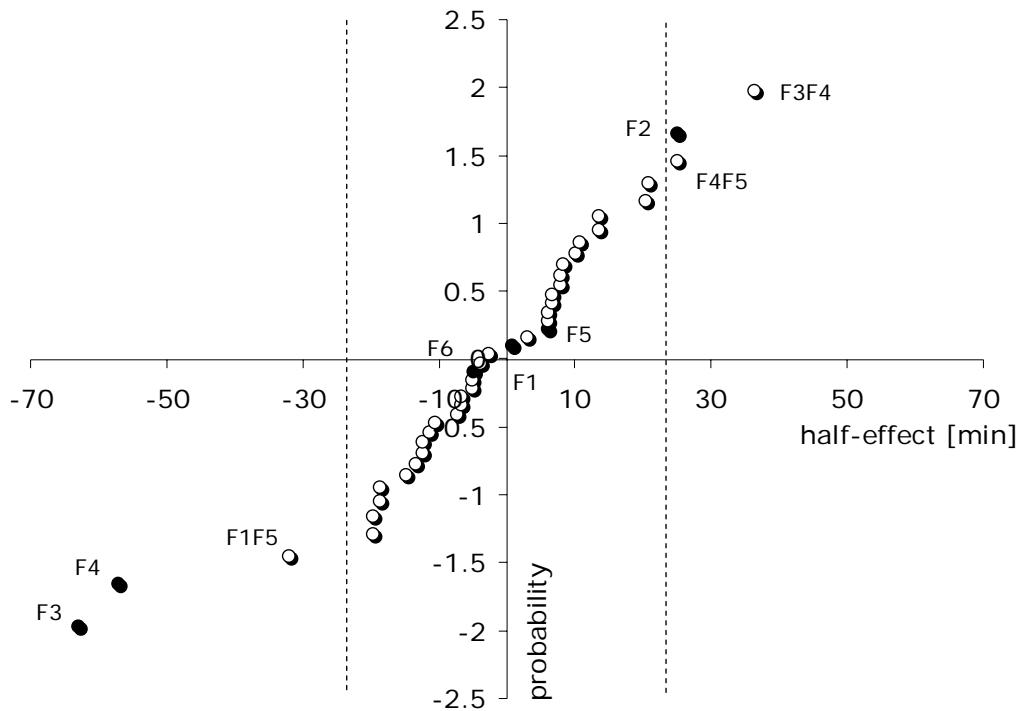

Figure 4. Plot of the normal half-effects on lag phase, where F1 is the biomass concentration, F2 the initial biomass concentration, F3 the type of sugar, F4 the culture mode, F5 the initial sugar concentration and F6 the temperature. Two levels were tested for each factor.

When considering a confidence interpretation of 95% in ANOVA calculations, reported in Table 4, the culture mode (F4) and the type of sugar (F3) were thus confirmed to be reliable effects with 100% of probability, and less clearly interpreted effects could now be characterized more accurately. The combined effect of temperature with the yeast strain (F1F6) and the type of sugar with the culture mode (F3F4) were also shown to be reliable effects, the probability being higher than 99%. While the initial biomass concentration (F2), the combination of culture mode and effect of sugar concentration (F4F5) and third order interactions (F2F4F5) were discarded because they do not present high enough accuracy.

Table 4. Analysis of variance of identified significant effects for the lagphase. Each factor, or combination of factors, is depicted as the probability that it is significant.

Anova				
Factor	Standard deviation	Degree of freedom	Fisher transform	Probability
Constant	754913	1		
F3	126882	1	35.92	100.0%
F4	104082	1	29.47	100.0%
F3F4	42413	1	12.01	99.8%
F1F6	32832	1	9.30	99.4%
F2	13820	1	3.91	93.8%
F4F5	13407	1	3.80	93.4%
F1F5F6	12207	1	3.46	92.2%
Residual	84769	24		
Total	1185325	32		

4.3 Specific growth rate

Culture experiments were followed during 12 hours thus providing enough data points to determine the specific growth rate with a regression on at least five points of exponential growth period. The specific growth rate values varied from 0.06 to 0.45 h⁻¹ (Figure 3) revealing the high impact of screened factors. In the literature a very broad range of values are reported for *K. marxianus* species. Vienne [12] screened various *K. marxianus* species for ethanol production from whey permeate and specific growth rate varied from 0.164 h⁻¹ for NRRL 665 to 0.318 h⁻¹ when varying the pre-culture and culture conditions. Zafar and Owais [14] reported, with *K. marxianus* MTCC 1288, specific growth rate values from 0.027 h⁻¹ to 0.157 h⁻¹ or even higher values of 0.56 h⁻¹ were reported by Fonseca [15] using *K. marxianus* ATCC 26548.

Normal plot linearization (Figure 5) shows that this variation is mainly due to one factor, namely the culture mode (F4). Indeed the growth rate increased by almost 70% ±5% when the pre-culture was performed anaerobically. This can be explained by the fact that switching from aerobic to anaerobic conditions induces an important adaptation of the metabolism the cells, which results in slower growth. With a probability higher than 99.9%, the ANOVA confirms the normal plot identification (Table 5).

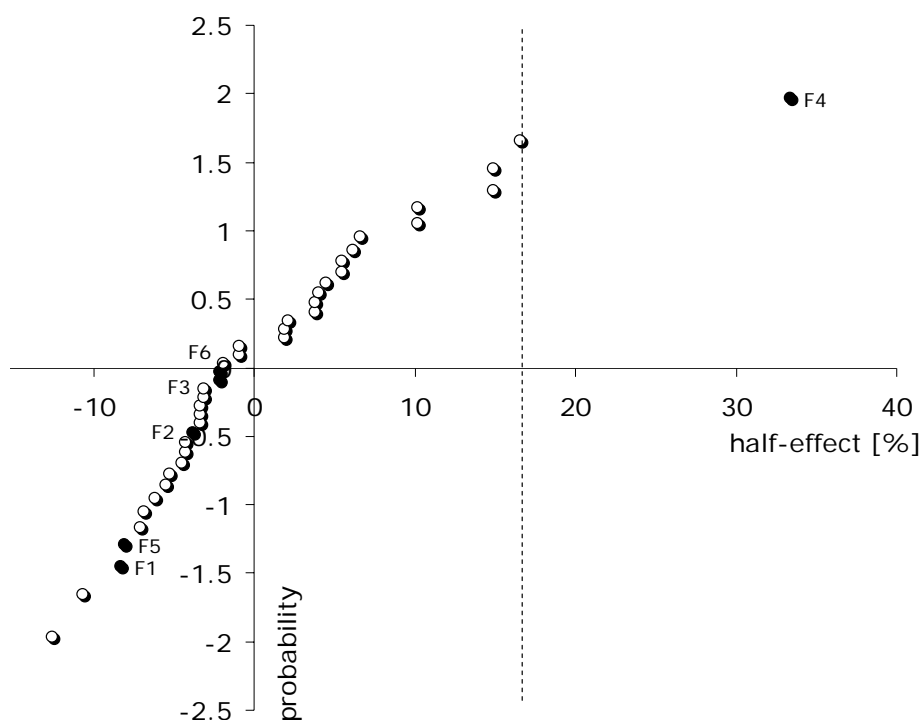

Figure 5. Plot of the normal half-effects on specific growth rate, where F1 is the biomass concentration, F2 the initial biomass concentration, F3 the type of sugar, F4 the culture mode, F5 the initial sugar concentration and F6 the temperature. Two levels were tested for each factor.

Table 5. Analysis of variance of identified significant effects for the specific growth rate. Each factor, or combination of factors, is depicted as the probability that it is significant.

Anova				
Factor	Standard deviation	Degree of freedom	Fisher transform	Probability
Constant	$8.0 \cdot 10^{-1}$	1		
F4	$8.9 \cdot 10^{-2}$	1	35.4	99.9%
F1F6	$2.2 \cdot 10^{-2}$	1	8.7	99.2%
F4F5	$1.3 \cdot 10^{-2}$	1	5.0	96.3%
F1F2	$9.1 \cdot 10^{-3}$	1	3.6	92.8%
F1	$5.5 \cdot 10^{-3}$	1	2.2	84.5%
F5	$5.2 \cdot 10^{-3}$	1	2.1	83.3%
Residual	$6.3 \cdot 10^{-2}$	25		
Total	1	32		

4.4 Pre-culture biomass

When identifying pre-culture biomass in shake-flasks, it is most important to compare similar inocula. These could not be standardized for the two strains, and therefore the discussion on biomass produced within 24 hours is described separately for each strain. Interpretation of the results obtained for both strains were very similar, consequently it was thus decided to present CBS 5795 as a model. The results varied from 4 ± 0.3 g/L to 63 ± 2 g/L depending on the pre-culture conditions (Figure 3). The biomass produced during the lag phase is normally not reported and thus no comparison with other data could be presented. Discussion will thus focus on data comparison of this work. Interpretation of the normal plot obtained with CBS 5795 (Figure 6) revealed that this variation was mainly due to the culture mode (F4) and the initial sugar concentration (F5). When producing biomass anaerobically, the energetic efficiency per mole of sugar was lower than when growing aerobically, with the result that $44\% \pm 3\%$ less biomass was obtained when switching from aerobic to anaerobic culture mode, while the highest sugar concentration increased the final biomass concentration by $54\% \pm 3\%$.

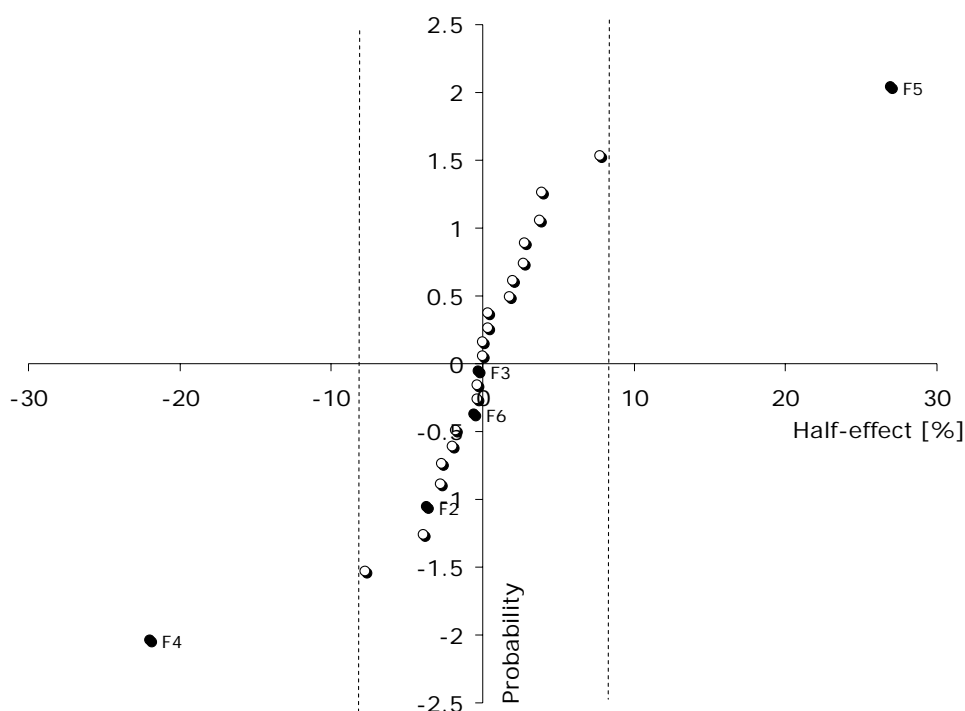

Figure 6. Plot of the normal half-effects on pre-culture biomass, where F1 is the biomass concentration, F2 the initial biomass concentration, F3 the type of sugar, F4 the culture mode, F5 the initial sugar concentration and F6 the temperature. Two levels were tested for each factor.

The latter measured effect could be the result of a carbon source limitation when yeasts are cultivated with only 20 g/L of sugar. The confidence interval of $\pm 16\%$ representing the experimental noise, tells us that under the experimental conditions employed, effects contained within this interval are not interpretable with enough accuracy. Similar results were obtained with CBS 397. ANOVA (Table 5) of these data confirms that a variation, between the two studied levels of sugar concentration and aeration mode, were significant factors for influencing the pre-culture biomass with an accuracy of respectively 98.3% and 97.9%. Relatively high values for F4F6 (94%) suggests temperature influences cells growth more when pre-culture is done aerobically compared to anaerobic conditions.

Table 6. Analysis of variance of identified significant effects for the pre-culture biomass. Each factor, or combination of factors, is depicted as the probability that it is significant.

Anova				
Parameter	Standard deviation	Degree of freedom	Fisher transform	Probability
Constant	44896	1		
F5	3267	1	1338	98.3%
F4	21709	1	889	97.9%
F4F6	269	1	110	94.0%
F2F3F5	269	1	110	94.0%
Residual	27	11		
Total	50898	16		

4.5 General discussion

While the effects resulting from the variation of our experimental factors could be made for both yeast strains, the yeast strain (F1) was not relevant for the interpretation of significant effects when comparing *K. marxianus* strains. Initial biomass (F2) was shown to have little impact on studied effects. Only the lag phase was reduced by 30 min when cultures were initiated with lower initial biomass. *K. marxianus* is capable of assimilating both lactose and glucose (F3) but switches from one metabolism to the other requires a certain time, resulting in a longer average lag phase of 130 min although this does not seem to affect either the μ or the pre-culture biomass. It is thus important to operate the pre-culture phase with the same carbon source as used in the fermentation experiments. Bioreactor fermentation experiments (chapter 3) demonstrated a fermentation period of 22 hours since the lag phase was minimized with CBS 5795. Reducing the lag phase by on average of 2.5 hours over this fermentation

period would result in an increase of 8% in overall productivity of the fermentation process. Choosing between aerobic or anaerobic conditions (F4) is more sensitive because this factor influences the lag phase, the growth rate and the produced biomass. Anaerobic conditions decrease the lag phase by 74% which, combined with a suitable sugar, results in no lag phase at all. Anaerobic conditions positively influenced cell growth during the fermentation culture by increasing μ >70%. However, cultivation of *K. marxianus* aerobically would result in almost 50% more biomass, which would be a considerable advantage since the ethanol production rate is proportional to biomass. This limitation was shown to be balanced by a higher growth rate in fermentation experiments, which resulted in an improvement of the global ethanol productivity. The carbon source concentration of 20 g/L was shown to be limiting with the consequence that *K. marxianus* was in stationary phase after pre-culturing. An initial sugar concentration of 100 g/L ensured that yeast cells were in exponential growth phase when introduced in the fermentation cultures. Finally a difference of temperature between pre-cultures and fermentation cultures was not identified as a relevant factor for either the lag phase or the growth rate but more surprisingly it did not affect pre-culture biomass. This could be explained if the optimal temperature for growth of the studied yeasts was between the two factor levels.

5. Conclusions

DOE methodology was efficiently used to establish a suitable set of experiments for obtaining as much information as possible from the fewest experiments. This experimental design showed that pre-culture conditions had an influence not only on the lag phase but also on the growth rate μ and the biomass produced.

The specific control of the pre-culture conditions was shown to help improving overall productivity by mainly reducing the lag phase. Of the studied factors, the type of sugar and the culture mode influenced the most the response parameters. Pre-culturing *K. marxianus* CBS 5795 and 397 anaerobically on lactose resulted in no lag phase during batch fermentation of whey permeate. Considering the lag phase reduction with the impact of the pre-culture on biomass and growth rate it was possible to increase the overall productivity of the fermentation process by 10-11%.

6. Nomenclature

ANOVA	Analysis of variance	
DOE	Design of experiment	
OFAT	One factor at a time	
μ	Specific growth rate	h^{-1}

Matrices

a_{ij}	Coefficient of the matrix of the model resulting from the producing of columns i and j of the matrix of experiments
E	Matrix of experiments
i	Refers to the experiment i
j	Refers to the level of the factor j
k	Number of columns of a matrix
N	Number of lines of a matrix
P	Probability of occurrence
R	Resolution of the factorial design informing on the interpretation degree of aliased effects
x	Element of a matrix
X	Matrix of the model
Y	Experimental data vector

7. References

- [1] Guimarães PMR, Teixeira JA, Domingues L. Fermentation of high concentrations of lactose to ethanol by engineered flocculent *Saccharomyces cerevisiae*. *Biotechnology Letters* 2008; 30(11): 1953-1958.
- [2] Ghaly AE, El-Taweel AA. Kinetics of batch production of ethanol from cheese whey. *Biomass and Bioenergy* 1994; 6(6): 465-478.
- [3] Kargi F, Ozmihci S. Utilization of cheese whey powder for ethanol fermentations: effects of operating conditions. *Enzyme and Microbial Technology* 2006; 38; 711-718.
- [4] Domingues L, Dantas MM, Lima N, Teixeira JA. Continuous ethanol fermentation of lactose by a recombinant flocculating *Saccharomyces cerevisiae* strain. *Biotechnology and Bioengineering* 1999; 64(6): 692-697.
- [5] Ghaly AE, Kamal M. Submerged yeast fermentation of acid cheese whey for protein production and pollution potential reduction. *Water Resource* 2004; 38: 631-644.
- [6] Ozmihci S, Kargi F. Kinetics of batch ethanol fermentation of cheese-whey powder solution as function of substrate and yeast concentration. *Bioresource Technology* 2007; 98: 2978-2984.
- [7] Ozmihci S, Kargi F. Ethanol fermentation of cheese whey powder solution by repeated fed-batch operation. *Enzyme and Microbial Technology* 2007; 41; 169-174.
- [8] Rosenberg AM, Wood TH. The modifying effect of culture age on heat sensitivity of Yeast. *Experimental Cell Research* 1957; 12(3): 692-694.
- [9] Perry SR, Knights AJ. Aerobic immobilized yeast cell culture: Influence of cell crowding and age in the immobilizing matrix on continuous culture performance. In: Jubilee Research Event, Inst Chem Engineers (eds), vols 1&2, Colorado; 1997: 849-852.
- [10] Smart KA, George E, Hodgson JA. Brewing Yeast-cell surface physical characteristics vary with culture age and condition. Kinetics of batch ethanol fermentation of cheese-whey powder solution as function of substrate and yeast concentration. *Bioresource In: Conference on Fermentation physiology-Biotechnology '94*, Inst Chem Engineers (eds), Colorado; 1994: 13-15.
- [11] Domingues L, Lima N, Teixeira JA. Alcohol production from cheese whey permeate using genetically modified flocculent yeast cells. *Biotechnology and Bioengineering* 2001; 72: 507-514.
- [12] Vienne P. La production d'alcool éthylique à partir d'un perméat de lactosérum doux. Switzerland: Swiss Federal Institute of Technology; Ph.D. thesis; 1984. p.80-ss.
- [13] Box GEP, Hunter WG, Hunter JS. *Statistics for Experimenters: An Introduction to Design, Data Analysis, and Model Building*. In: John Wiley and Sons; 1978.
- [14] Zafar S, Owais M. Ethanol production from crude whey by *Kluyveromyces marxianus*. *Biochemical Engineering Journal* 2006; 27: 295-298.
- [15] Fonseca GG, Henzle E, Wittmann C, Gombert AK. The yeast *Kluyveromyces marxianus* and its biotechnological potential. *Applied Microbial Biotechnology* 2008; 79: 339-354.

Chapter 5

Ethanol fermentation of whey and hydrolyzed whey permeate: yeast strain selection and performance optimization

1. Abstract

The principal organism studied for ethanol fermentation from whey permeate is *Kluyveromyces fragilis* due to its ability to directly ferment lactose. However, such direct fermentation yeasts generally suffer from low conversion yields and poor tolerance to ethanol, which results in large volumes of diluted ethanol and thus high energy demands for distillation and purification. An alternative is to utilize indirect fermentation yeasts, such as *Saccharomyces cerevisiae*, which show considerably better ethanol fermentation performance but has the disadvantage that an expensive enzymatic hydrolysis step is required prior to fermentation. In this study both types of process have been characterized involving eight ethanol producing yeasts. The culture conditions were optimized for each strain using a design of experiment methodology. Highest conversion yield and alcohol tolerance were achieved with *S. cerevisiae* Ethanol Red ($Y_{P/S} = 0.662$ C-mol/C-mol, $c_{EtOH_{max}} = 148$ g/L), of the indirect fermentation yeasts, and with *K. marxianus* CBS 5795 ($Y_{P/S} = 0.660$ C-mol/C-mol, $c_{EtOH_{max}} = 79$ g/L) of the direct fermentation yeasts studied. From an economic point of view, for an equal ethanol yield, the difference in alcohol tolerance does not compensate for the pretreatment costs, which are required for lactose hydrolysis when utilizing Ethanol Red. As a result, direct fermentation should be preferred for fermenting whey permeate to ethanol and a maximum productivity of 6.24 g/(L·h) at 37°C and pH 4 was achieved with *K. marxianus* CBS 5795.

This chapter was submitted for publication in *Bioresource Technology*
de Glutz FN, Holliger C, Marison IW. Ethanol fermentation of whey permeate and hydrolyzed whey permeate: yeast strain selection and performance optimization.

2. Introduction

The disposal of whey through the fermentation of lactose to ethanol has received widespread attention, and several production technologies have been developed. In one approach the lactose contained in whey is hydrolyzed enzymatically using β -D-galactosidase and then fermented by non-lactose-utilizing yeasts such as *Saccharomyces cerevisiae* [1, 2]. In an extension of this method the enzymes and yeast may be co-immobilized [3]. A second, more practical and economical approach, is to directly ferment whey, either in the raw form, deproteinized or mixed with other sugar sources, by lactose-utilizing yeasts [4-14]. Although reports exist on the screening of yeasts with the capacity of producing ethanol directly from lactose [15], no clear assessment has been reported so far on the relative efficiency of direct whey permeate fermentation compared to the indirect systems. The result is that *Kluyveromyces fragilis* has been the yeast applied in most commercial plants for many years [16, 17]. In batch fermentations *K. fragilis* utilizes more than 95% of the lactose of non-concentrated whey with a conversion efficiency of 80-85% of the theoretical value of 0.538 kg ethanol / kg lactose [18].

In Switzerland, and other countries where there is decentralized cheese manufacturing, the production of ethanol from non-concentrated cheese whey is not economically feasible, mainly because the levels of ethanol obtained reach only about 2% (v/v), making distillation and transport costs too high [19]. In order to obtain higher alcohol concentration, ultrafiltered (UF) whey permeate concentrate must be used with specific alcohol tolerant strains [15-18]. Direct fermentation yeasts are reported to be highly alcohol intolerant showing significant loss of viability at ethanol concentrations as low as 20 g/L. Such yeasts also ferment lactose less efficiently than *Saccharomyces cerevisiae* does when fermenting glucose. Typical yields of 0.400 kg ethanol / kg lactose are reported for direct fermentation [20], resulting in considerably lower productivity than for indirect fermentation processes. Thus indirect fermentation organisms represent an interesting alternative because ethanol production yields (0.520 kg ethanol / kg lactose) and relative alcohol tolerance (100-120 g/L) are much higher [21]. The fact that the latter yeast are incapable of directly assimilating lactose results in the need for an enzymatic hydrolysis step, which renders comparison of both production pathways and the best strategy for bioethanol production from whey difficult.

For this reason the production of ethanol from whey permeate has been characterized for four direct fermentation yeasts, and four indirect ones, and the fermentation performance discussed in view of an industrial ethanol production process.

2.1 Microbial Growth Kinetics

Fermentations can be carried out as batch, continuous or fed-batch experiments. Batch culture is an example of a closed culture system containing a limited initial amount of nutrient. After inoculation the growing cells go through a defined number of phases. The first phase, termed lag phase, corresponds to the transition step between an initial physiological state and the growth phase. Following a period during which the growth rate of the cells is kept at its maximal value, this phase is known as the log or exponential phase [22]. The exponential phase may be described by:

$$\frac{dx}{dt} = \mu x$$

where x is biomass concentration (g/L)

t is time [h]

μ is specific growth rate [h^{-1}]

On integration this yields:

$$x_t = x_0 e^{\mu t}$$

where x_0 is initial biomass concentration (g/L)

x_t is biomass concentration after time t [h]

Taking natural logarithm, we obtain:

$$\ln x_t = \ln x_0 + \mu t$$

A plot of the natural logarithm of the biomass concentration versus time during the exponential phase should yield a straight line, the slope of which is the maximum specific growth rate, μ_{max} . It should be pointed out that this is only valid during the exponential growth phase, with growth generally becoming limited through the depletion of substrate, accumulation of inhibitory products or changes to the physical environment [23]. Thus the growth rate slows and the cells enter the stationary phase, and ultimately the decline or death phase where the specific death rate is higher than the specific growth rate.

The decrease in growth rate and cessation of growth, due to the depletion of substrate, may be described by the relationship between μ and the residual growth-limiting substrate and can be described by the Monod relation. The similarity in behavior of limited enzymatic kinetic and cell growth leads to the following equation:

$$\mu = \mu_{\max} \frac{s}{K_s + s}$$

where s is the limiting substrate concentration [g/L]

K_s is the saturation constant for substrate s [g/L]

This relation can take other forms when describing specific inhibition:

By the substrate:
$$\mu = \mu_{\max} \frac{s}{K_s + s + s^2 / K_{is}}$$

By the product (non competitive):
$$\mu = \mu_{\max} \frac{s}{K_s + s} \frac{K_p}{K_p + p}$$

where K_{is} and K_p are the inhibition constants of the various substrates and products respectively [g/L]

p is the concentration of the product [g/L]

As an analogy with growth, the specific production rate, q_p , can be defined as:

$$q_p = (dP / dt) / X \quad [\text{g}_{\text{product}} / \text{g}_{\text{cells}} \cdot \text{h}]$$

and the specific substrate consumption rate, q_s :

$$q_s = (dS / dt) / X \quad [\text{g}_{\text{substrate}} / \text{g}_{\text{cells}} \cdot \text{h}]$$

In addition to the kinetic parameters of growth, the metabolic activities of microorganisms can be characterized by their respective yields.

The biomass yields, $Y_{X/S}$, is defined as:

$$Y_{X/S} = \Delta X / \Delta S \quad [\text{g}_{\text{cells}} / \text{g}_{\text{substrate, consumed}}]$$

In this case, the substrate is considered as the reference component for yield calculations. When the microorganisms produce metabolic products in addition to cells (such as fermentation products like ethanol), specific product yields must also be defined [24]. For ethanol, the specific product yield, $Y_{P/S}$, is described by:

$$Y_{P/S} = \Delta P / \Delta S \quad [\text{g}_{\text{ethanol}} / \text{g}_{\text{substrate, consumed}}]$$

The theoretical maximum yield of ethanol, assuming that all of the initial sugar is converted into ethanol (Equation 1'), is 0.667 C-mol ethanol / C-mol lactose.

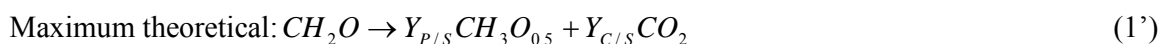
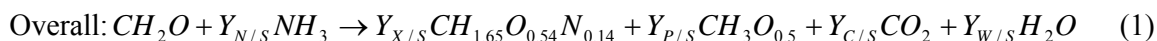

2.2 Ethanol fermentation

The word metabolism comes from the Greek word “*metabole*” which means “change”, and refers to the chemical transformations which occur in living organisms. Enzyme-catalyzed reactions are characterized by very small changes of the molecules. However our metabolism implies lots of chain reactions so that very substantial chemical changes can occur [25]. These sequences of reactions are termed metabolic pathways. Metabolism can be divided in anabolism and catabolism.

Anabolism is the set of reactions involved in the building-up of complex molecules from simple precursors or biosynthesis ultimately leading to an increase in cell number. Catabolism consists in breaking-down complex compounds into simple molecules for two main goals: provision of appropriate compounds for subsequent biosynthetic reactions and by providing chemical energy and reducing power to drive biosynthesis.

2.2.1 Catabolism

Kluyveromyces fragilis and *K. lactis*, which unlike *S. cerevisiae* can metabolize lactose aerobically, contain a lactose permease system for lactose transport [26] into the cell where it is hydrolyzed to glucose and galactose which enter glycolysis (Figure 2).

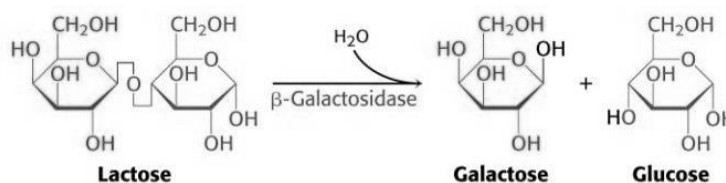

Figure 2. Enzymatic conversion of lactose in glucose and galactose

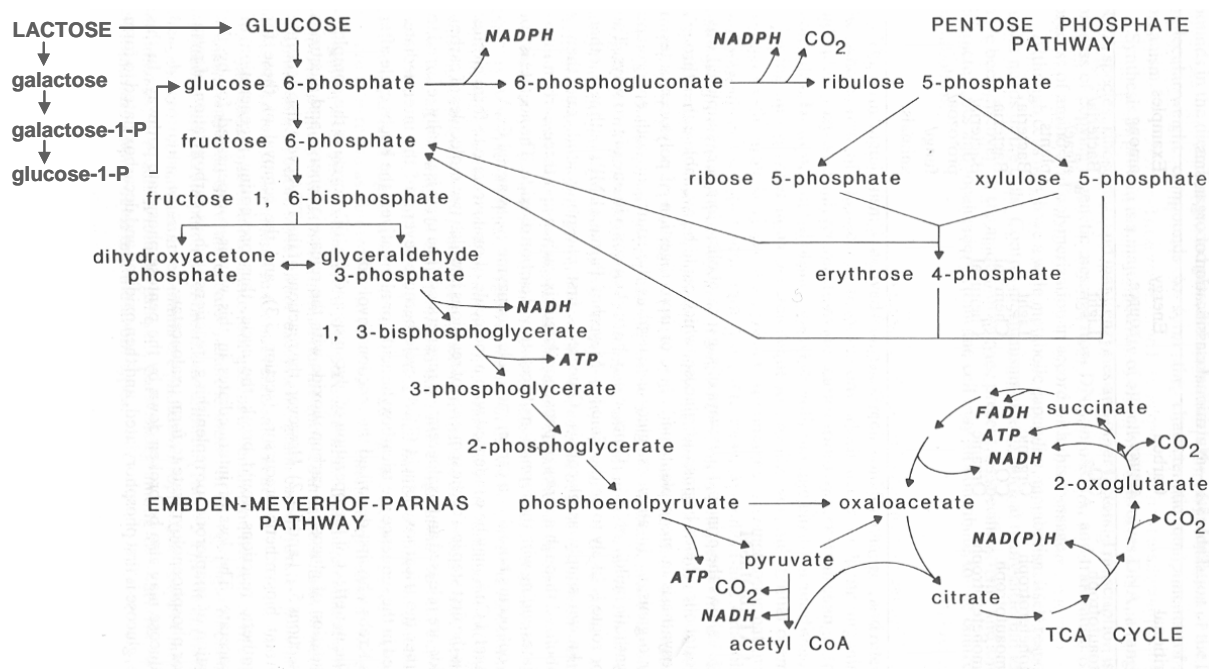

Figure 3. Embden-Meyerhof-Parnas and Pentose phosphate metabolic pathways [27].

Figure 3 shows the main pathways of sugar catabolism in a very simplified way. Complex sugars are first reduced to sugar monomers by enzyme-catalyzed reactions before entering the various metabolic pathways [28].

The major metabolic route for the breakdown of glucose is glycolysis, also called the Embden-Meyerhof-Parnas (EMP) pathway. Glucose is first phosphorylated and then metabolized through a series of phosphorylated intermediates of six and three carbons ending with the formation of acetate and carbon dioxide. This acetate is, bound to a carrier molecule, coenzyme A, to form acetyl CoA. Acetyl CoA may form citrate by condensing with a molecule of oxaloacetate. This is the first step in a cyclic sequence of reactions in which two molecules of CO_2 are released. This cycle is termed the tricarboxylic acid (TCA) cycle, because a number of the intermediates are tricarboxylic acids.

Glucose can also be broken down by the pentose phosphate pathway. By this way, glucose is first phosphorylated and then oxidized and decarboxylated to form ribulose 5-phosphate, then, by a series of complex reactions, transformed into 6-phosphate and glyceraldehydes 3-phosphate. Metabolism of six molecules of glucose 6-phosphate, via the pentose phosphate pathway, results in the degradation of one complete molecule of glucose to carbon dioxide. The principal function of this pathway is the provision of NADPH and precursors for biosynthetic reactions.

2.2.2 Fermentation

Fermentation is the simplest mode of energy generation and is used by microorganisms growing under anaerobic conditions. Glucose is metabolized by glycolysis with the production of pyruvic acid, ATP and NADH (Figure 4).

First glucose is converted into fructose-1,6-bisphosphate implying the consumption of two molecules of ATP. Fructose-1,6-bisphosphate is then cleaved into two triose phosphate. Glyceraldehyde-3-phosphate is oxidized by the reduction of NAD^+ , and then esterified with inorganic phosphate resulting in 1, 3-bisphosphoglyceric acid which is then converted to pyruvic acid with the production of two molecules of ATP [27, 29].

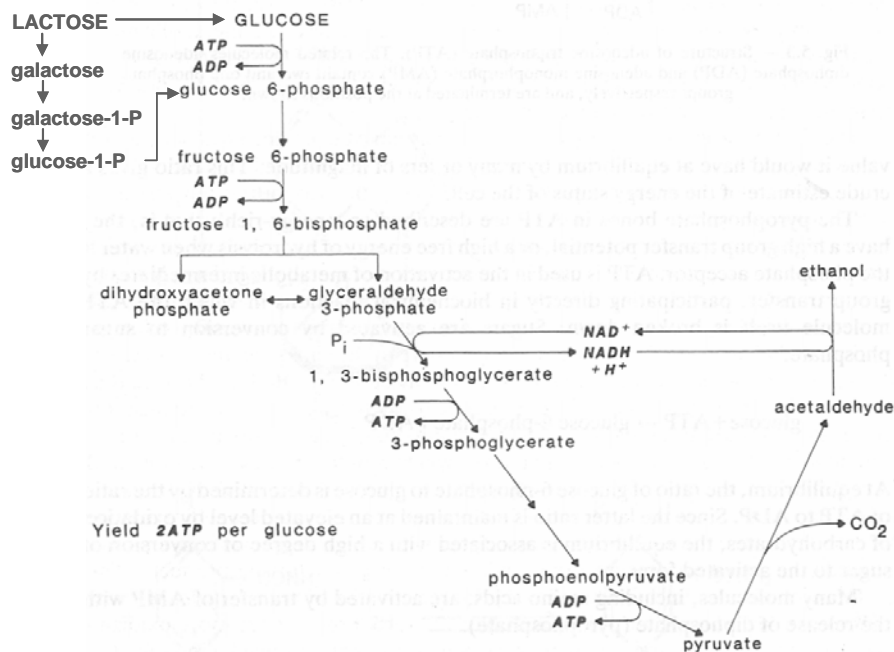

Figure 4. Alcoholic fermentation of the yeast *S. cerevisiae*. All ATP is produced by substrate-level phosphorylation, and NAD is cycled between the oxidized and reduced forms [27].

Synthesis of ATP usually occurs in reactions which involve the participation of ADP and either 1,3-bisphosphoglycerate or phosphoenolpyruvate.

The NADH produced during the glycolytic pathway must be reoxidized. This is the main characteristic of this type of fermentations, namely that the electron acceptor is an organic compound. In the alcoholic fermentation, pyruvate is decarboxylated to acetaldehyde, which plays the role of electron acceptor [30]. It is then reduced to ethanol by electrons coming from

NADH, in the process regenerating NAD required for continued functioning of the glycolytic pathway. Most fermentations result in the production of several major end-products, the formation of which is influenced by environmental and physiological factors and is a property of each individual organism. Products, such as acetate, butyrate, butanol, isopropanol, propionate, lactate, glycerol or butanediol, can be formed by metabolism of pyruvate from multiple microorganisms (bacteria and yeasts) and via different pathways (Figure 5).

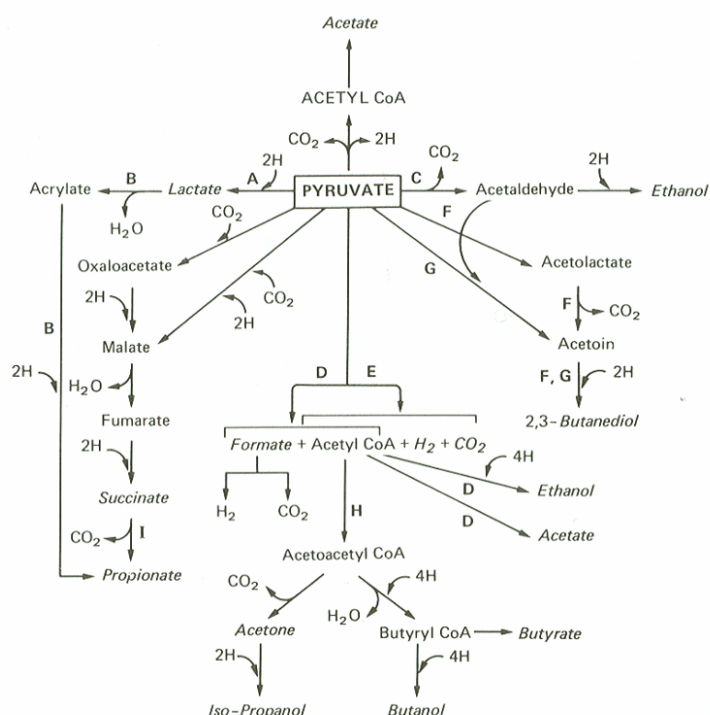

Figure 5. Possible fermentation products of pyruvate. Pyruvate formed by the catabolism of glucose is further metabolized by pathways which are characteristic of particular organisms and which serve as a biochemical aid to identification [31].

By comparison with respiration and photosynthesis, fermentation is only producing ATP by substrate-level phosphorylation, which is associated with a low yield of ATP (2 mole ATP/mole glucose) and results in the need for consumption of large quantities of substrate in order to support modest growth. A consequence of this is that most of the carbon and energy of the substrate consumed ends up in the reduced fermentation end-products, e.g. in the ethanol. Although these products are in fact metabolic wastes, many have considerable value as commercial products. In our case ethanol results from this low efficiency pathway. There is also a great interest in exploiting biological fermentations as an alternative to chemical synthesis for the economic production of fuels, solvents, and fine chemicals, being termed green biotechnology of which biofuels are a major part [32-35].

3. Materials and Methods

3.1 Yeast strains and inocula

The yeast strains characterized in this study were selected from yeast culture collections. Among them, four strains were capable of directly fermenting whey and whey permeate: *Kluyveromyces marxianus* strains CBS 6432, CBS 397 and CBS 5795 (Centraalbureau voor Schimmelculturen, Utrecht, The Netherlands) and ATCC 8619 (American Type Culture Collection, Teddington, UK). The other four studied strains were glucose/galactose-utilizing yeasts, capable of fermenting hydrolyzed whey permeate: *Saccharomyces cerevisiae* ATCC 200062 (ATCC, Teddington, UK), Ethanol Red and Safdistil C-70 (Fermentis-Lesaffre, France) and *Saccharomyces bayanus* (Avidor, Switzerland). Stock cultures were stored as suspensions in 9 g/L NaCl and 10 g/L glycerol at -80°C. Cells were re-activated in a 1 liter baffled shake-flask containing 100 mL YPL medium at 30°C for 24h on rotary shaker at 200 rpm. Two cultures in baffled shaken flasks of 100 mL each were used to prepare the inocula. After 24 h of incubation at 30°C, the two precultures were centrifuged at 4°C (10 minutes at 1500 g) and the cell pellets resuspended in 10 mL sterile water and used immediately. YPL medium contained 40 g/L lactose, 6 g/L yeast extract (Oxoid, Hampshire, England) and 5 g/L Bacto™Peptone (Becton, Le Pont de Claix, France) and was sterilized at 121°C for 20 min.

3.2 Fermentation media

Direct fermentation culture medium was whey permeate powder (Cremo, Villars-sur-Glâne, Switzerland) reconstituted to a lactose concentration of 40 g/L, completed with 3.75 g/L yeast extract (Oxoid, Hampshire, England) to avoid nitrogen limitation [4], in ultra-pure water and sterilized by filtration (0.22 µm, Steriltop, Millipore Corporation, Billerica, USA). Sterile antifoam agent (Structol J647, Schill&Seilacher, Germany), 1 mL/L was added to the sterile medium immediately prior to inoculation.

Indirect fermentation culture medium mimicked a hydrolyzed lactose medium by dissolving yeast extract (6 g/L), peptone (5 g/L) and glucose-galactose in equal quantities (20g : 20g) into ultra-pure water and sterilized by filtration (0.22 µm, Steriltop, Millipore Corporation, Billerica, USA). Sterile antifoam agent (Structol J647, Schill&Seilacher, Germany), 1 mL/L was added to the sterile medium immediately prior to inoculation.

3.3 Culture conditions

Characterization of yeast productivity was performed using the BioXplore system (HEL, Barnet, UK) comprising four 1-liter bioreactor vessels in each of which temperature, dissolved oxygen, agitation and pH were monitored and controlled.

Ethanol production yield, biomass evolution and final ethanol concentrations were characterized for pH values of 4, 5 and 6; an initial sugar concentration of 40 g/L, and fermentation temperatures of 25, 30 and 37°C. pO_2 was maintained below 3% throughout the experiments by gassing with nitrogen in order to ensure anaerobic conditions.

Determination of ethanol tolerance was achieved by a fed-batch operation. Shake-flask cultures were performed in 500 mL Erlenmeyers with initially 100 g/L lactose whey permeate. Mixing was achieved by stirring with a magnetic stirrer at 200 rpm in a temperature controlled incubator. Successive additions of 50g/L pure lactose or glucose-galactose (according to the yeast strain) were repeated until no more ethanol was produced.

3.4 Reagents and metabolite analysis

Glucose, galactose, lactose and ethanol concentrations were determined by HPLC analysis (1100 series, Agilent Technologies, Palo Alto, USA). An ion-exchange chromatography column (Supelcogel H, 30 cm x 4.6 mm; 9 μ m, Supelco, Bellefonte, USA) was used at 60°C and a 0.005 M H_2SO_4 solution in ultrapure water was applied at a constant eluent flow rate of 0.6 mL/min. Metabolites were then measured using a refractive index detector. Cell density was determined spectrophotometrically by measuring optical density at 600 nm (OD_{600}).

4. Results

Kinetic and stoichiometric characteristics were compared for eight different ethanol-producing yeasts. To facilitate characterization and comparison, it was important to grow the yeasts under optimal conditions. This was achieved by a series of cultures carried out with each yeast for different temperatures and pH conditions. Response surfaces were generated from 5 experimental conditions for each strain, four at the extrema and one middle value.

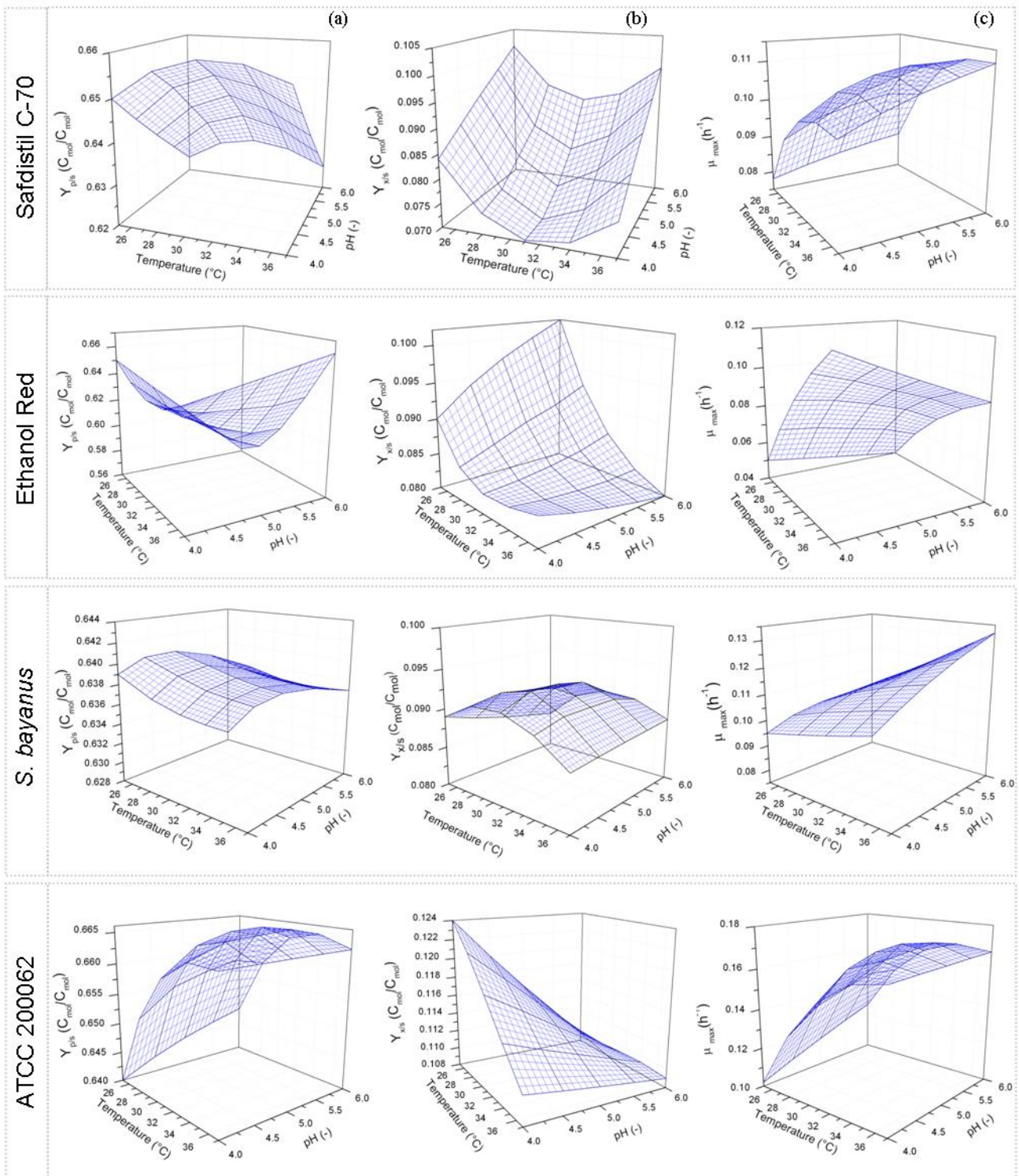

Figure 6. Performance of batch cultures of indirect ethanol producing yeast from synthetic hydrolyzed whey permeate of *S. cerevisiae* Safdistil C-70, Ethanol Red, ATCC 200062 and *S. bayanus*. The effect of pH and temperature was measured on (a) ethanol production yield ($Y_{p/s}$), (b) biomass production yield ($Y_{x/s}$) and (c) maximum specific growth rate (μ_{max}).

4.1 Indirect whey fermenting yeasts

Figure 6 presents the results for the characterization of *S. bayanus* and *S. cerevisiae* ATCC 200062, Ethanol Red and Safdistil C-70 on hydrolyzed lactose medium. The influence of culture conditions on the ethanol production yield, the biomass production yield and the maximum specific growth rate, is apparent and shows the importance of comparing data for yeast strains under multiple conditions.

Figure 6 shows that each yeast responds differently to variations in culture conditions, with certain strains being pH-sensitive (*S. cerevisiae* Ethanol Red and Safdistil C-70), others temperature-sensitive (*S. cerevisiae* ATCC 200062) while certain strains (*S. bayanus*) are sensitive to neither. However the optimum responses, listed in Table 1, show that most of the selected strains approach the theoretical ethanol production yield ($Y_{P/S}$) of 0.67 C-mol/C-mol with little variation. Maximal biomass production yields ($Y_{X/S}$) and maximum specific growth rate (μ_{\max}) of ATCC 200062 appears to be significantly higher than the other yeast strains studied resulting in a shorter fermentation period. Total carbon balance measurements revealed a good match of values exposed in Table 1 ($\pm 11-18\%$).

Table 1. Optimized ethanol performance and culture conditions for indirect fermentation yeasts grown on synthetic hydrolyzed whey showing maximum ethanol production yields ($Y_{P/S}$), biomass production yields ($Y_{X/S}$) and maximal specific growth rate (μ_{\max}).

Yeast strain	Temperature °C	pH -	$Y_{P/S}$ Cmol·Cmol ⁻¹	$Y_{X/S}$ Cmol·Cmol ⁻¹	μ_{\max} h ⁻¹
<i>S. cerevisiae</i> ATCC 200062	30	5	0.664 ± 0.020	0.114 ± 0.006	0.163 ± 0.014
<i>S. cerevisiae</i> Ethanol Red	37	6	0.662 ± 0.020	0.080 ± 0.004	0.090 ± 0.020
<i>S. cerevisiae</i> Safdistil C-70	37	4	0.656 ± 0.019	0.077 ± 0.004	0.112 ± 0.020
<i>S. bayanus</i>	37	4	0.642 ± 0.019	0.087 ± 0.005	0.125 ± 0.018

Kinetics of fed-batch fermentations, under the optimized culture conditions enabled the identification of the ethanol tolerance of the yeast and determination of kinetics prior to total product inhibition. The results, presented in Table 2, show that *S. bayanus* is the most resistant strain, tolerating alcohol concentrations as high as 162 g/L while *S. cerevisiae* ATCC 200062 is inhibited at ethanol concentration as low as 85 g/L.

Table 2. Kinetics and productivity data for indirect fermentation yeasts grown on synthetic concentrated hydrolyzed whey. Maximum ethanol tolerance (c_{EtOHmax}), fermentation time global productivity ($Q_{p,\text{global}}$) and maximum productivity ($Q_{p,\text{max}}$) are reported for each strain under their optimized culture conditions.

Yeast strain	c_{EtOHmax} g·L ⁻¹	time h	$Q_{p,\text{global}}$ ¹ g·L ⁻¹ ·h ⁻¹	$Q_{p,\text{max}}$ ² g·L ⁻¹ ·h ⁻¹
<i>S. bayanus</i>	162	119	1.61 ± 0.04	3.60 ± 0.25
<i>S. cerevisiae</i> Ethanol Red	148	48	2.76 ± 0.10	6.24 ± 0.44
<i>S. cerevisiae</i> Safdistil C-70	120	64	2.00 ± 0.05	3.82 ± 0.30
<i>S. cerevisiae</i> ATCC 200062	85	29	2.27 ± 0.08	5.51 ± 0.26

¹ represents overall fermentation productivity between t_0 and t at which maximum ethanol concentration was achieved.

² represents the productivity during exponential phase.

Despite the high alcohol tolerance (162 g/L) *S. bayanus* exhibited the slowest fermentation (119h) and lowest overall productivity ($Q_{p,\text{global}}=1.61$ g/L·h; $Q_{p,\text{max}}=3.60$ g/L·h) compared with yeasts such as Ethanol Red and Safdistil C-70 which showed higher productivities ($Q_{p,\text{global}}=2.76$ g/L·h and 2.00 g/L·h respectively) and growth kinetics (Figure 7).

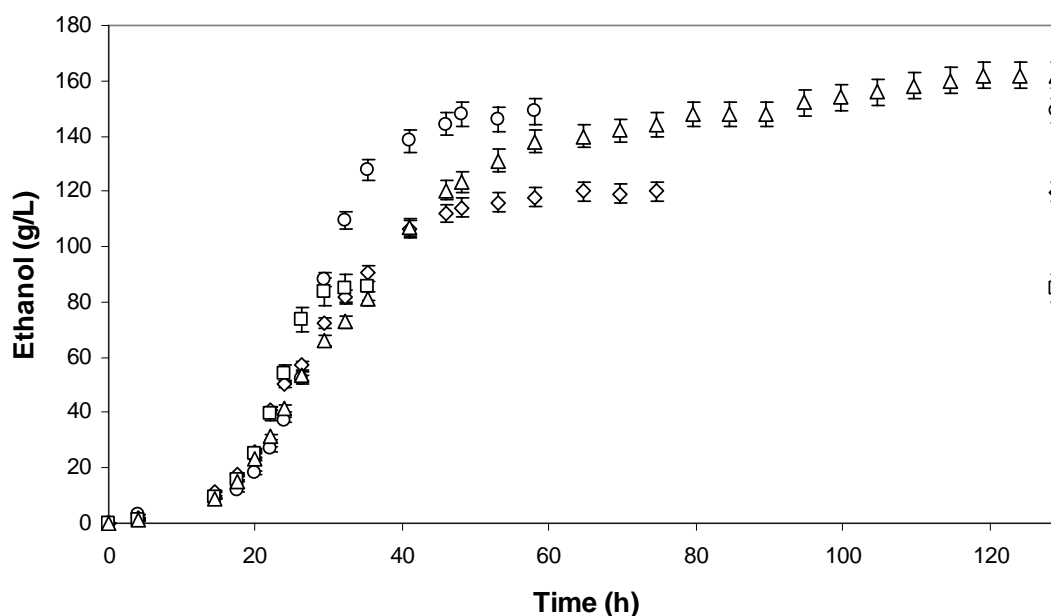

Figure 7: Kinetics of ethanol production and maximum ethanol tolerance from synthetic concentrated hydrolyzed whey permeate with batch cultures of (\diamond) *S. cerevisiae* Safdistil C-70, (\square) ATCC 200062 and (Δ) *S. bayanus*, grown under optimized culture conditions.

4.2 Direct whey fermenting yeasts

For comparison Figure 8 shows the influence of culture parameters on growth and ethanol production of the direct fermentation yeast metabolism *Kluyveromyces marxianus* CBS 6432, CBS 397 and CBS 5795 and ATCC 8619 on whey permeate. $Y_{P/S}$, $Y_{X/S}$ and μ_{\max} values reported as the z axis and presented as an experimental surface response to pH and temperature describe growth of these direct yeasts on whey permeate first and then compare to indirect yeasts on hydrolyzed whey. Comparison of the results (Table 3) on whey permeate shows that direct fermentation yeasts are more strongly dependent on culture conditions compared to indirect ones. Ethanol production yields were similar (0.625-0.660 C-mol/C-mol) compared to the indirect fermentation yeasts (0.642-0.664 C-mol/C-mol). Only *K. marxianus* CBS 397 was an exception with a low yield of only 0.490 C-mol/C-mol. Important differences to indirect fermentation yeasts were observed with respect to biomass yield and maximum specific growth rate. $Y_{X/S}$ of direct fermentation yeasts was generally slightly lower and μ_{\max} was between 30-60% of the growth rate of direct fermentation yeasts. *K. marxianus* CBS 397 was again an exception to these general trends. Based on ethanol yields, two strains are particularly interesting, namely CBS 5795 and ATCC 8619. The slightly smaller $Y_{P/S}$ observed for ATCC 8619 is compensated by a shorter fermentation, due to the high μ_{\max} (0.094 h⁻¹) compared with CBS 5795 (0.047 h⁻¹). Total carbon balances show very accurate matching of values exposed in Table 3 (\pm 4-10%).

Table 3. Optimized ethanol performance and culture conditions for direct fermentation yeasts grown on concentrated whey permeate showing maximal ethanol production yield ($Y_{P/S}$), biomass production yield ($Y_{X/S}$) and maximal specific growth rate (μ_{\max}).

Yeast strain	Temperature °C	pH	$Y_{P/S}$ Cmol·Cmol ⁻¹	$Y_{X/S}$ Cmol·Cmol ⁻¹	μ_{\max} h ⁻¹
<i>K. marxianus</i> CBS 5795	37	4	0.660 ± 0.020	0.050 ± 0.020	0.047 ± 0.015
<i>K. marxianus</i> ATCC 8619	30	5	0.645 ± 0.019	0.082 ± 0.031	0.094 ± 0.023
<i>K. marxianus</i> CBS 6432	30	5	0.625 ± 0.018	0.078 ± 0.029	0.074 ± 0.006
<i>K. marxianus</i> CBS 397	37	6	0.490 ± 0.030	0.167 ± 0.041	0.302 ± 0.026

Comparison of ethanol tolerance (Table 4) shows that CBS 397 is very strongly inhibited by ethanol at concentrations as low as 9.4 g/L, while ATCC 8619, CBS 5795 and CBS 6432 can tolerate 7-9 fold higher concentrations (71, 79 and 81 g/L respectively), with fermentation times ranging from 11 to 32 hours.

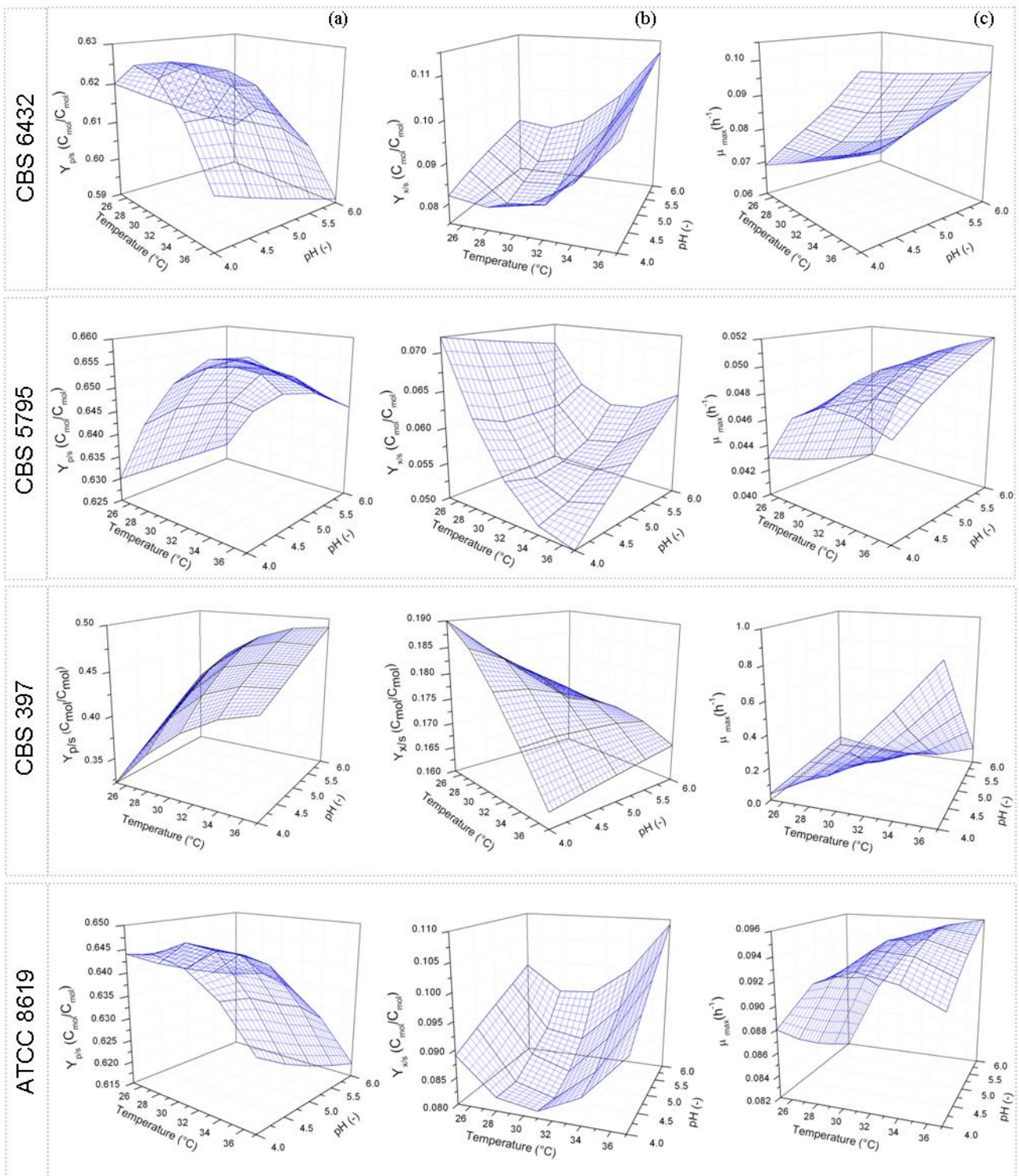

Figure 8: Performance of batch cultures of indirect ethanol producing yeast from whey permeate of *K. marxianus* CBS 6432, CBS 5795, CBS 397 and ATCC 8619. The effect of pH and temperature on (a) ethanol production yield ($Y_{p/s}$), (b) biomass production yield ($Y_{x/s}$) and (c) maximum growth rate (μ_{max}) was determined.

Table 4. Kinetics and productivity data for direct fermentation yeasts from concentrated whey permeate in batch cultures. Maximal ethanol tolerance (c_{EtOHmax}), fermentation time global productivity ($Q_{\text{p,global}}$) and maximal productivity ($Q_{\text{p,max}}$) are reported for each strain grown under their optimized culture conditions.

Yeast strain	c_{EtOHmax} $\text{g}\cdot\text{L}^{-1}$	time h	$Q_{\text{p,global}}^1$ $\text{g}\cdot\text{L}^{-1}\cdot\text{h}^{-1}$	$Q_{\text{p,max}}^2$ $\text{g}\cdot\text{L}^{-1}\cdot\text{h}^{-1}$
<i>K. marxianus</i> CBS 6432	81	32	2.33 ± 0.32	3.44 ± 0.42
<i>K. marxianus</i> CBS 5795	79	22	3.29 ± 0.28	6.15 ± 0.39
<i>K. marxianus</i> ATCC 8619	71	26	2.14 ± 0.29	2.55 ± 0.32
<i>K. marxianus</i> CBS 397	9.4	11	0.61 ± 0.03	0.72 ± 0.06

¹ represents overall fermentation productivity between t_0 and t at which maximum ethanol concentration was achieved.

² represents the productivity during exponential phase.

The fermentation kinetics are shown in Figure 9 where it can be observed that growth of CBS 397 ceased after 10 hours with no further ethanol production observed after 11 hours. On the other hand, CBS 5795 fermented the most rapidly reaching an ethanol concentration, equivalent to CBS 6432 and higher than that of ATCC 8619.

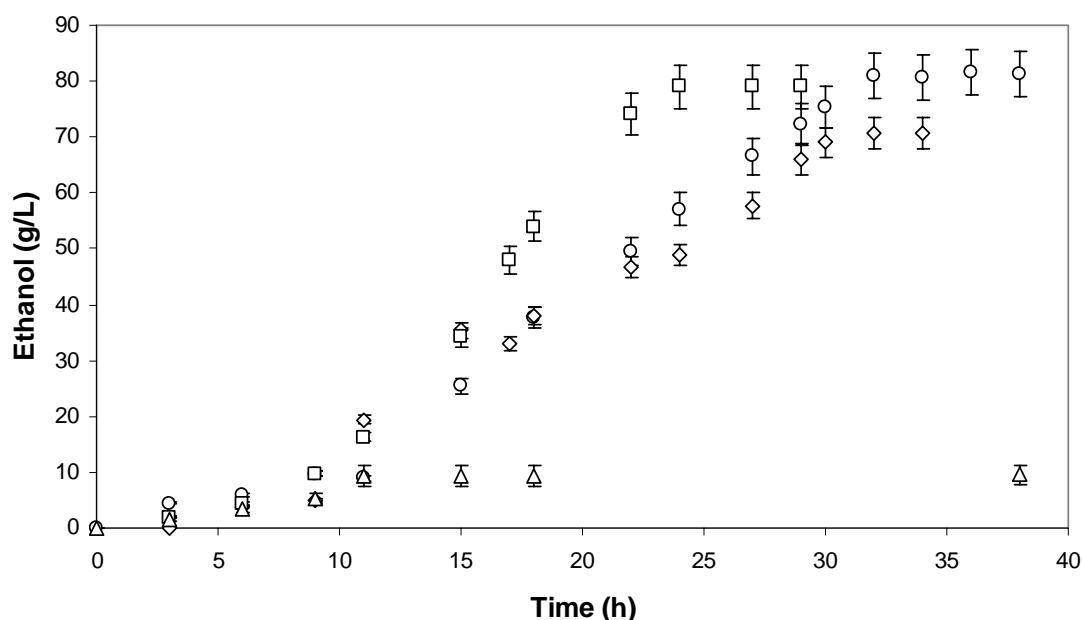

Figure 9: Kinetics of ethanol production and maximum ethanol tolerance from concentrated whey permeate with batch cultures of (\diamond) ATCC 8619, (\circ) CBS 6432, (\square) CBS 5795 and (Δ) CBS 397 grown under optimized culture conditions.

5. Discussion

Direct whey fermenting yeasts are reported to be highly inhibited by the product, with toxicity appearing at ethanol concentrations as low as 20 g/L. These are unrealistically low values and would require large fermentation plants and uneconomic energy costs for distillation (Chapter 1). However, the first criterion for selection of a producing yeast must still be $Y_{P/S}$, due to the relatively low added-value of the product compared with the substrate. Direct fermentation yeasts are also reported to ferment lactose less efficiently than *S. cerevisiae*, fermenting glucose with $Y_{P/S}$ of about 0.499 C-mol/C-mol. However, these yeasts cannot metabolize lactose directly; therefore an expensive whey pretreatment step (hydrolysis) is required. As a result it is difficult to determine which of the production methods would be most suited to whey fermentation at the whey production site (dairy). If transportation of dilute whey to a central bioethanol site is required, the costs of transportation / refrigeration for such a poorly stable substrate would be positive (currently approximately 60% of alcohol costs), which would suggest that on-site hydrolysis and membrane concentration prior to transport would be a viable alternative (Chapter 1).

As a result a range of both direct and indirect lactose-fermenting yeasts were studied in order to determine which route is the most suitable using currently available alcohol tolerant strains.

5.1 Indirect whey fermenting yeasts

Safdistil C-70 appears to be a relatively efficient indirect fermentation yeast with relatively high alcohol productivity and tolerance. The parameter which appears to affect growth and production most significantly is pH, with the yeast fermenting more efficiently under acidic conditions. Thus at pH 4 the highest values on the defined experimental surface were observed, reaching a $Y_{P/S}$ of 0.656 C-mol/C-mol, a $Y_{X/S}$ of 0.077 C-mol/C-mol and a μ_{max} of 0.112 h⁻¹, the tendencies of the results suggest that by reducing the pH even further, even higher yields should be possible. Previous results on Safdistil have already demonstrated this pH dependency reporting a maximum final ethanol concentration of 105 g/L when fermented at pH 4.3 and 40°C, while at pH 3 ethanol production decreased by almost 30% [36]. Growth of the yeast was sensitive to temperature with a maximum $Y_{X/S}$ observed at 37°C. Since the maximum specific growth rate and $Y_{P/S}$ are strongly dependent on pH, it is clear that ethanol production is coupled to yeast growth, while $Y_{P/S}$ and $Y_{X/S}$ show opposite trends. As

stoichiometric equilibrium of equation 1 must be fulfilled, and if no co-product is produced, an increase of $Y_{P/S}$ will result in a decrease of $Y_{X/S}$ as $Y_{N/S}$ is constant (0.04 C-mol/C-mol) and $Y_{C/S}$ is linked to the yeast metabolism.

S. cerevisiae ATCC 200062 also presented strong temperature dependence with respect to $Y_{P/S}$, $Y_{X/S}$ and μ_{\max} , and, like Safdistil C-70, ethanol production appears to be related to cell growth and $Y_{P/S}$ measurements are inversely proportional to $Y_{X/S}$. The optimal conditions measured were at 30°C and pH 5, where $Y_{P/S}$ reached 0.664 C-mol/C-mol, the highest result obtained in this study, while $Y_{X/S}$ was 0.114 C-mol/C-mol. The link between $Y_{P/S}$ and μ_{\max} explains the high specific growth rate for *S. cerevisiae* ATCC 200062, which reached 0.163 h⁻¹. Literature describes *S. cerevisiae* ATCC 200062 as a thermophilic yeast mostly studied for producing ethanol from hydrolyzed cellulose materials [37-39]. The better results observed at 37°C compared to 25°C thus agree with this reported thermophilic preference. Average ethanol yields of 0.54 C-mol/C-mol [49] and 0.52 C-mol/C-mol [38] were measured at respectively 42 and 45°C [39], which is 20% lower than the values measured in the present study. This could be explained by the operating conditions. In this study glucose and galactose were used in a complex medium while in these former studies simultaneous saccharification and fermentation were carried out from lignocellulosic material and may result either in incomplete hydrolysis of the substrate or in some growth limitation, which was not observed in the present study. Finally better fermentation performance was reported at neutral pH compared to acidic conditions [39], which agrees with present conclusions.

S. bayanus is well-known in the wine industry due to its ability to ferment to very high ethanol levels. Under the conditions studied here, no significant dependency on either pH or temperature was observed with respect to $Y_{P/S}$. Although, like *S. cerevisiae* strains, a correspondence between $Y_{P/S}$ and μ_{\max} was also observed. Thus only at 37°C and pH 6 was a significant increase in μ_{\max} reflected in the value of $Y_{X/S}$. The optimum growth conditions for this strain were observed at 37°C and pH 4, where $Y_{P/S}$ reached 0.642 C-mol/C-mol, $Y_{X/S}$ 0.098 C-mol/C-mol and μ_{\max} 0.125 h⁻¹. *S. bayanus* is usually reported to be a cryophilic yeast, fermenting more efficiently at about 10-12°C. However, at that low temperature much longer periods are required (two weeks) for fermenting the initial (250 g/L) glucose medium [40]. The same paper characterizes ethanol production between 28°C and 35°C and no relevant difference was reported which agrees with the non-dependency on temperature which was

also observed in this study. High ethanol tolerance with *S. bayanus* was reported by Amin [41] and ethanol concentration as high as 123 g/L could be measured. In this work *S. bayanus* was the most tolerant yeast studied, reaching 162 g/L ethanol, although long fermentation periods were required.

The yeast Ethanol Red also showed very good results with respect to ethanol production yield with a value of 0.662 C-mol/C-mol at 37°C and pH 6. By contrast, the biomass production yield (0.080 C-mol/C-mol) at these conditions was slightly lower. However, the growth rate of Ethanol Red (0.09 h⁻¹) was the lowest of the four indirect fermentation yeasts studied, thus high inoculum densities would be required to reduce the fermentation time. Of the remaining parameters pH had little effect on $Y_{P/S}$, $Y_{X/S}$ or μ_{max} , while temperature significantly increased ethanol production and growth rates. Fermentis (Fermentis-Lesaffre, Marcq-en-Baroeul, France) characterizes Ethanol Red fermentation for temperature values from 30-40°C while the pH value is not specifically provided. At 37°C, very efficient glucose conversion is reported (94% of maximum theoretical yield) and final ethanol concentration of 142 g/L is achieved. These data agree with the limiting ethanol concentration measured in this study (148 g/L) while little higher yield was measured for optimal pH and temperature conditions (99% of maximum theoretical yield). Ethanol Red is actually used for industrial fermentation processes from sugar beet but little is reported in the literature. However, an ethanol yield of 68% of maximum theoretical yield was reported with mixed substrate culture of xylose, glucose, cellobiose and hemicellulose [42] and a maximum ethanol concentration of 116 g/L has already been achieved when fermenting corn residues [43].

The main reason for testing yeasts which cannot directly assimilate lactose is that they are reported to exhibit high alcohol tolerance and thereby produce higher concentrations than lactose fermenting yeast [46, 51, 53], thereby reducing the energy requirement for distillation. Consequently, while ethanol production yields are very similar for *S. cerevisiae* ATCC 200062, Safdistil C-70 and Ethanol Red, ethanol tolerances were 85, 120 and 148 g/L respectively.

Ethanol Red appears to be the optimal yeast studied for indirect fermentation of hydrolyzed whey due to its high fermentation efficiency coupled to a high ethanol resistance.

5.2 Direct whey fermenting yeasts

By comparison, of the direct whey-fermenting yeasts, higher conversion yield was observed for *K. marxianus* CBS 6432 at 30°C and pH 5. The $Y_{P/S}$ trend surface (Figure 8) shows that both pH and temperature changes are important for ethanol production with an optimum at acidic pH, and temperatures of 25-30°C. Biomass production rate strongly increases with temperature, with a minimum at 30°C, and $Y_{X/S}$ seems to be related to μ_{max} . Maximum specific growth rate occurred at 37°C, which also corresponds to the temperature at which the highest biomass conversion yield was obtained. A temperature of 30°C and pH 5 have been reported to be the most efficient for the fermentation of 15% lactose whey permeate by immobilized cultures of *K. marxianus* CBS 6432 [44]. Vienne [4] reported a slightly higher optimal temperature (38°C) in acidic pH. Under these conditions very similar $Y_{P/S}$ (0.603 C-mol/C-mol compared to 0.625 C-mol/C-mol in this study) and $Y_{X/S}$ (0.057 C-mol/C-mol compared to 0.078 C-mol/C-mol) were obtained but maximum specific growth rate was much larger (0.311 h^{-1}). Finally ethanol concentration of 72.2 g/L was achieved when fermenting a 250 g/L lactose medium in batch mode at 30°C [45]. Under these conditions, volumetric productivity of 1 g/L·h and biomass yield of 0.045 C-mol/C-mol was reported, which agrees with the results obtained in this study for *K. marxianus* CBS 6432 (81 g/L, 2.3 g/(L·h), 0.078 C-mol/C-mol).

Of the eight yeasts studied, *K. marxianus* CBS 397 was the least efficient with respect to ethanol production. A reason for this may be due to the production of fermentation products other than ethanol, such as glycerol which could result in reduced ethanol production yield [46]. In the present study glycerol production was not characterized therefore this could not be confirmed. Under optimal conditions the ethanol production yield for CBS 397 was 0.490 C-mol/C-mol, which is very low compared to the other yeasts. This could be the result of a different growth and maintenance coefficient with sugar for fermentation [47, 48].

On the other hand the biomass production yield (0.167 C-mol/C-mol) was almost two times higher than for other direct fermentation organisms, while μ_{max} was approximately three times higher. These data clearly show that *K. marxianus* CBS 397 has rapid and efficient growth, compared with the other strains, yet is unsuitable for efficient ethanol production. A similar ethanol production rate was reported by Anderson [49] where a maximum of 4.6% (w/v) was obtained with CBS 397 when fermenting 10% (w/v) lactose whey permeate with a $Y_{P/S}$ of 78.5% of theoretical yield. However other reports [4] present higher ethanol production

efficiency and ethanol tolerance (0.56 C-mol/C-mol and 83 g/L respectively) when fermented at 35°C and pH 5.5. This difference may be due to the formation of non desired products, such as glycerol and 2-phenylethanol, which have been reported in the literature [49, 50] as major fermentation products of CBS 397 under certain conditions, and lower ethanol production efficiency and cell viability which could result from a single or combination of toxic effects [51]. The observed relative non-dependence on pH between 4-6 is confirmed by the results of Vivier [52]. Toxic conditions below pH 3 or above pH 10 were identified by this author. The preferred thermophilic conditions identified in this study (35°C) agree with reported literature values [4, 51, 53].

Among direct fermentation organisms, CBS 5795 was the most efficient yeast. Ethanol production yields were close to the theoretical maximum value (0.667 C-mol/C-mol) the relative ratio ($Y_{P/S} / Y_{X/S}$) was also the highest of all eight yeasts studied with the graphs of $Y_{P/S}$ and $Y_{X/S}$ (Figure 8) clearly demonstrating the relationship between ethanol production and growth. The optimum experimental conditions were identified to be 37°C and pH 4 where $Y_{P/S}$ reached 0.660 C-mol/C-mol, $Y_{X/S}$ 0.050 C-mol/C-mol and μ_{max} 0.047 h⁻¹. In previous studies, the fermentation of 15% lactose concentrated whey permeate also resulted in very efficient ethanol production (92% [64] and 95 % [4] of the theoretical maximum value) and 10% higher biomass yield (0.062 C-mol/C-mol) [4]. Less dependence on pH agrees with the results obtained by Burgess [54] which reported that no significant effect could be measured on ethanol production for pH values from 4.6 to 5.6. The yeast *K. marxianus* CBS 5795 was also reported to be an alcohol tolerant direct fermenting yeast. Gianetto [55] presented a continuous tubular reactor process where ethanol concentrations higher than 50 g/L were achieved although concentrations as high as 78 g/L have been achieved with concentrated whey [53].

K. marxianus CBS 5795 appeared to be very efficient at producing ethanol, while minimizing substrate consumption for growth. The low growth rate would require a high inoculation density and a two stage culture, involving an initial aerobic phase to achieve a high biomass concentration followed by switching to anaerobic / micro-aerophilic ethanol production.

K. marxianus ATCC 8619 showed similar results to *K. marxianus* CBS 5795 for $Y_{P/S}$ (0.645 C-mol/C-mol) and $Y_{X/S}$ (0.082 C-mol/C-mol), the optimum experimental conditions being 30°C and pH 5. However, the results suggest that reducing the pH even further might improve $Y_{P/S}$. With the exception of CBS 397, ATCC 8619 showed the highest specific growth rate of

all the direct fermentation yeasts studied and an ethanol production yield almost as high as CBS 5795. *K. marxianus* ATCC 8619 has been widely utilized for ethanol production from whey [54-58]. Optimal temperature and pH conditions of 30°C and 5.5 respectively are reported in literature [59] and ethanol efficiencies as high as 90%, 98.3% and up to 99.6% of theoretical maximum yield have been reported [60-62], when fermenting 10, 28 and 15% lactose whey permeate in 72, 72 and 42 hours respectively. Ethanol resistance up to 79.3 g/L was even reported when fermenting 15% whey permeate with an efficiency >99% of theoretical yield at pH 4 and 35°C [63]. Under these conditions a volumetric productivities between 1.3 - 3 g/L·h were reported which is similar to the values presented in this study (2.14 - 2.54 g/L·h).

Lactose has a low solubility (240 g/L at 20°C), which limits the maximum ethanol concentration that can be expected from a direct fermentation organism. Furthermore, using current membrane technology, it is difficult to concentrate whey permeate above 200 g/L. Thus the ethanol tolerance required of a direct fermentation yeast would need to be approximately 104 g/L ethanol, since the maximum theoretical ethanol yield is 0.538 g ethanol /g lactose. From the results it can be seen that *K. marxianus* CBS 397 would be completely unviable (ethanol tolerance 20g/L) while *K. marxianus* CBS 5795, 6432 and ATCC 8619 showed considerable alcohol tolerance of 79 g/L, 81 g/L and 71 g/L respectively. For all four direct fermentation yeasts, temperature was shown to have the largest influence on growth and ethanol production and is therefore the critical parameter.

6. Conclusions

The indirect fermentation yeasts studied presented very good characteristics with Ethanol Red determined to be the most suitable organism for fermenting concentrated whey permeate, with high alcohol production yield ($Y_{P/S} = 0.662$ C-mol/C-mol) and alcohol tolerance (148 g/L). In addition the rapid kinetics of production of Ethanol Red allowed the maximum ethanol level to be obtained within 48 hours compared to 119 hours for *S. bayanus*.

In this study three of the four direct fermentation organisms (CBS 5795, CBS 6432 and ATCC 8619) showed a much higher alcohol tolerance than has been commonly considered, with CBS 5795 achieving the theoretical maximum ethanol production yield, similar to those for indirect fermentation yeast, yet resistant to 79 g/L ethanol.

Comparison of the results to simulated production models based on direct or indirect bioethanol production [64-66, Chapter 1], would suggest that direct whey permeate fermentation is the best way to produce bioethanol from whey permeate with *K. marxianus* CBS 5795, determined to be the most efficient yeast for this purpose. On the other hand a multi-substrate bioethanol plant would almost certainly require a stable mixed-culture, which is a real challenge, or Ethanol Red could be used after suitable pretreatment of the whey permeate through enzyme hydrolysis.

7. Nomenclature

μ	Specific growth rate	h^{-1}
EtOH	Ethanol	
K_i	Saturation constant	$\text{g}\cdot\text{L}^{-1}$
NADH	Dihyronicotinamide adenine dinucleotide	
OD	Optical density	
q_i	Specific productivity	$\text{g}\cdot\text{g}^{-1}\cdot\text{h}^{-1}$
Q_i	Volumetric productivity	$\text{g}\cdot\text{L}^{-1}\cdot\text{h}^{-1}$
TCA	Tricarboxylic acid cycle	
Y_{ij}	Yield coefficient of substance j on substance i	$\text{C}\cdot\text{mol}\cdot\text{C}\cdot\text{mol}^{-1}$ $\text{g}\cdot\text{g}^{-1}$
YPL	Yeast extract-Peptone-Lactose medium	

Subscripts

global	Overall mean value
i	Refers to compound i
j	Refers to compound j
P	Refers to the produced ethanol
S	Refers to limiting nutrient
X	Refers to biomass
C	Refers to CO_2
W	Refers to water
N	Refers to nitrogen
t	Conditions at time t
0	Initial conditions

8. References

- [1] Fonseca GG, Henzle E, Wittmann C, Gombert AK. The yeast *Kluyveromyces marxianus* and its biotechnological potential. *Applied Microbial Biotechnology* 2008; 79: 339-354.
- [2] Rajoka MI, Khan S, Shahid R. Kinetics and regulation studies of the production of β -galactosidase from *Kluyveromyces marxianus* grown on different substrates. *Food Technology and Biotechnology* 2003; 41: 315-320.
- [3] Roukas T, Lazarides HN. Ethanol production from deproteinized whey by beta-galactosidase coimmobilized cells of *Saccharomyces cerevisiae*. *Journal of Industrial Microbiology* 1991; 7(1): 15-18.
- [4] Vienne P, von Stockar U. Alcohol from whey permeate: strain selection, temperature and medium optimization. *Biotechnology and Bioengineering* 1983; 13: 421-435.
- [5] Rocha MH, Lora EES, Venturini OJ. Life Cycle Analysis of different alternatives for the treatment and disposal of ethanol vinasse. *Zuckerindustrie* 2008; 133(2): 88-93.
- [6] Thomsen MH, Hauggaard-Nielsen H. Sustainable bioethanol production combining biorefinery principles using combined raw materials from wheat undersown with clover-grass. *Journal of Industrial Microbiology & Technology* 2008; 35(5): 303-311.
- [7] Kotaka A, Bando H, Kaya M, Kato-Murai M, Kuroda K, Sahara H, Hata Y, Kondo A, Ueda M. Direct ethanol production from barley beta-glucan by sake yeast displaying *Aspergillus oryzae* beta-glucosidase and endoglucanase. *Journal of Bioscience and Bioengineering* 2008; 105(6): 622-627.
- [8] Carere CR, Sparling R, Cicek N, Levin DB. Third generation biofuels via direct cellulose fermentation. *International Journal of Molecular Sciences* 2008; 9(7): 1342-1360.
- [9] Gibson BR, Boulton CA, Box WG, Graham NS, Lawrence SJ, Linforth RST, Smart KA. Carbohydrate utilization and the lager yeast transcriptome during brewery fermentation. *Yeast* 2008; 25(8): 549-562.
- [10] Xiros C, Topakas E, Katapodis P, Christakopoulos P. Evaluation of *Fusarium oxysporum* as an enzyme factory for the hydrolysis of brewer's spent grain with improved biodegradability for ethanol production. *Industrial Crops and Products* 2008; 28(2): 213-224.
- [11] Maddox IS, Gutierrez NA. Biotechnological developments in New Zealand. *Critical Reviews in Biotechnology* 1996; 16(2): 119-143.
- [12] Becerra M, Baroli B, Fadda AM, Mendez JB, Siso MIG. Lactose bioconversion by calcium-alginate immobilization of *Kluyveromyces lactis* cells. *Enzyme and Microbial Technology* 2001; 29 (8,9): 506-512.
- [13] Jurascik M, Guimaraes P, Klein J, Domingues L, Teixeira J, Markos J. Kinetics of lactose fermentation using a recombinant *Saccharomyces cerevisiae* strain. *Biotechnology & Bioengineering* 2006; 94(6): 1147-1154.
- [14] Beccerra M, Prado SD, Rodriguez-Belmonte E, Cerdan ME, Siso MIG. Metabolic engineering for direct lactose utilization by *Saccharomyces cerevisiae*. *Biotechnology Letters* 2002; 24(17): 1391-1396.

- [15] Maiorella BL, Castillo FJ. Ethanol, biomass, and enzyme-production for whey waste abatement. *Process Biochemistry* 1984; 19(4): 157-161.
- [16] Demott BJ. Determination of ethanol in whey-sugar solutions by freezing. *Journal of Food Protection* 1982; 45(1): 26-28.
- [17] Demott GJ, Deaughon FA, Herald PJ. Fermentation of lactose in direct-acid-set cottage wheeze whey. *Journal of Food Protection* 1981; 44(8): 588-ss.
- [18] Mawson AJ. Bioconversions for whey utilization and waste abatement. *Bioresource Technology* 1994; 47: 195-203.
- [19] Tin CSF, Mawson AJ. Ethanol production from whey in a membrane recycle bioreactor. *Process Biochemistry* 1993; 28: 217-221.
- [20] Jeong YS, Vieth WR, Matsuura T. Fermentation of lactose to ethanol with recombinant yeast in an immobilized yeast membrane bioreactor. *Biotechnology & Bioengineering*. 1991; 37: 587-590.
- [21] Dale MC, Moelhman M, Walker S. Industrial scale production of ethanol from whey permeate mother liquor using a multi-stage continuous fermentation system. *Paper American Society of Agricultural Engineers* 1997; 3: 1-10.
- [22] Stephanopoulos GN, Aristidou AA, Nielsen J. *Metabolic Engineering Principles and Methodologies*. Academic Press. San Diego; 1998.
- [23] Sanchez, OJ, Cardona CA. Trends in biotechnological production of fuel ethanol from different feedstocks. *Bioresource Technology* 2008; 99: 5270-5295.
- [24] Staniszewski M, Kujawski W, Lewandowska M. Ethanol production from whey in bioreactor with co-immobilized enzyme and yeast cells followed by pervaporative recovery of product-Kinetic model predictions. *Journal of Food Engineering* 2007; 82: 618-625.
- [25] Castrillo JI, Ugalde UO. Patterns of energy metabolism and growth kinetics of *Kluyveromyces marxianus* in whey chemostat culture. *Applied Microbiology and Biotechnology* 1993; 40: 386-393.
- [26] Barron N, Marchant R, McHale L, McHale AP. Partial characterization of β -glucosidase activity produced by *Kluyveromyces marxianus* IMB3 during growth on cellobiose containing media at 45°C. *Biotechnology Letters* 1995; 17: 1047-1050.
- [27] Mitchell WJ, Slaughter JC. Biology and biochemistry for chemists and chemical engineers. In: Sherp DH (ed). *Ellis Horwood series in chemical engineering*. Chichester: Halstad Press; 1989: 86-90.
- [28] de Bruijne AW, Schuddemat J, van den Broek PJA, van Steveninck J. Regulation of sugar transport systems of *Kluyveromyces marxianus*: the role of carbohydrates and their catabolism. *Biochemistry and Biophysics Actuality* 1988; 939: 569-576.
- [29] Fernandes PA, Sena-Esteves M, Moradas-Ferreira P. Characterization of the glyceraldehyde-3-phosphate dehydrogenase gene family from *Kluyveromyces marxianus* - polymerase chain reaction single-strand conformation polymorphism as a tool for the study of multigenic families. *Yeast* 1995; 11: 725-733.
- [30] Blank LM, Lehmebeck F, Sauer U. Metabolic-flux and network analysis in fourteen hemiascomycetous yeasts. *FEMS Yeast Resource* 2005; 5: 545-558.

- [31] Stanbury PF, Whitaker A. Principles of fermentation technology. Oxford: Pergamon Press; 1984.
- [32] Duvnjak Z, Houle C, Mok KL. Production of ethanol and biomass from various carbohydrates by *Kluyveromyces fragilis*. Biotechnology Letters 1987; 9: 343-346.
- [33] Ferrari MD, Loperena L, Varela H. Ethanol production from concentrated whey permeate using a fed-batch culture of *Kluyveromyces fragilis*. Biotechnology Letters 1994; 16: 205-210.
- [34] Kotoupas A, Rigas F, Chalaris M. Computer-aided process design, economic evaluation and environmental impact assessment for treatment of cheese whey wastewater. Desalination 2007; 213: 238-252.
- [35] Viola Egidio, Cardinale M, Santarcangelo R, Villone A, Zimbardi F. Ethanol from eel grass via steam explosion and enzymatic hydrolysis. Biomass and Bioenergy 2008; 32: 613-618.
- [36] Leiper KA, Schlee C, Tebble I Stewart GG. The fermentation of beet sugar syrup to produce bioethanol. Journal of the institute of brewing 2006; 112(2): 122-133.
- [37] Tucker MP, Nagle NJ, Jennings EW, Ibsen KN, Aden A, Nguyen QA, Kim KH, Noll S. Conversion of distiller's grain into fuel alcohol and a higher-value animal feed by dilute-acid pretreatment. Applied Biochemistry and Biotechnology 2004;113-116; 1139-1159.
- [38] Kadam KL, Schmidt SL. Evaluation of *Candida acidothermophilum* in ethanol production from lignocellulosic biomass. Applied Microbiology and Biotechnology 1997; 48: 709-713.
- [39] Suryawati L, Wilkins MR, Bellmer DD, Huhnke RL, Maness NO, Banat IM. Simultaneous saccharification and fermentation of kanlow switchgrass pretreated by hydrothermolysis using *Kluyveromyces marxianus* IMB4. Biotechnology and Bioengineering 2008; 101(5): 894-902.
- [40] Kishimoto M. Fermentation characteristics of hybrids between the cryophilic wine yeast *Sacchamoyces-bayanus* and the mesophilic wine yeast *Saccharomyces-cerevisiae*. Journal of Fermentation and Bioengineering 1994; 77(4): 432-435.
- [41] Amin G, Van den Eynde E, Verachtert H. Determination of by-products formed during the ethanolic fermentation, using batch and immobilized cell systems of *Zymomonas mobilis* and *Saccharomyces bayanus*. European Journal of Applied Microbiology and Biotechnology 1983; 18: 1-5.
- [42] Tania IG, Hous X, Hilstrom T, Ahring BK. Enzymatic hydrolysis and ethanol fermentation of high cry matter wet-exploded wheat straw and low enzyme loading. Applied Biochemistry and Biotechnology 2008; 148: 35-44.
- [43] Murthy GS, Sall ED, Metz SG, Foster G, Singh V. Evaluation of a dry corn fractionation process for ethanol production with different hybrids. Industrial Crops and Products 2008; 29: 67-72.
- [44] Droulez C. Production d'éthanol à partir de lactose par une levure immobilisée, performances et limitations. Switzerland: Swiss Federal Institute of Technology; Ph.D. thesis; 1992. p 33-74.

- [45] Gunasekaran P, Kamini NR. High ethanol productivity from lactose by immobilized cells of *Kluyveromyces fragilis* and *Zymomonas mobilis*. *World Journal of Microbiology and Biotechnology* 1991; 7: 551-556.
- [46] Wheamei J, Speckman RA, Crang RE, Steinberg MP. Enhanced conversion of lactose to glycerol by *Kluyveromyces fragilis* utilizing whey permeate as a substrate. *Applied and Environmental Microbiology* 1989; 55(3): 573-578.
- [47] Van Uden N, Madeira-Lopes A. Yield and maintenance relations of yeast growth in the chemostat at superoptimal temperatures. *Biotechnology and Bioengineering* 2004; 18(6): 791-804.
- [48] Wang D, Xu Y, Hu J, Zhao G. Fermentation kinetics of different sugars by apple wine yeast *Saccharomyces cerevisiae*. *Journal of the Institute of Brewing* 2004; 110(4): 340-346.
- [49] Anderson PJ, McNeil K, Watson K. High-efficiency carbohydrate fermentation to ethanol at temperatures above 40°C by *Kluyveromyces marxianus* var. *marxianus* isolated from sugar mills. *Applied and Environmental Microbiology* 1986; 51(6): 1314-1320.
- [50] Etschmann MMW, Sell D, Schrader J. Screening of yeasts for the production of the aroma compound 2-phenylethanol in a molasses-based medium. *Biotechnology Letters* 2003; 25: 531-536.
- [51] Stark D. Extractive bioconversion of 2-phenylethanol from L-phenylalanine by *Saccharomyces cerevisiae*. Switzerland: Swiss Federal Institute of Technology; Ph.D. thesis; 2001. p 129-163.
- [52] Vivier D, Ratomahenina R, Moulin G, Galzy P. Study of physicochemical factors limiting the growth of *Kluyveromyces marxianus*. *Journal of Industrial Microbiology* 1993; 11: 157-161.
- [53] Laham-Guillaume M, Moulin G, Galzy P. Sélection de souches de levures en vue de la production d'alcool sur lactosérum. *Le Lait* 1979 ; 588; 489-496.
- [54] Burgess KJ, Kelly J. Alcohol production by yeast in concentrated ultrafiltration permeate from cheddar cheese whey. *Irish Journal of Food Science and Technology* 1979; 3: 1-9.
- [55] Gianetto A, Berruti F, Blick BR, Kempton AG. The production of ethanol from lactose in a tubular reactor by immobilized cells of *Kluyveromyces fragilis*. *Applied Microbiology and Biotechnology* 1986; 24: 277-281.
- [56] Tin CSF, Mawson AJ. Ethanol production from whey in a membrane recycle bioreactor. *Process Biochemistry* 1993; 28: 271-221.
- [57] Ghaly A, Al-Taweel AA. Kinetics of batch production of ethanol from cheese whey. *Biomass and Bioenergy* 1994; 6: 465-478.
- [58] Shabtai Y, Mandel C. Control of ethanol production and monitoring of membrane performance by mass-spectrometric gas analysis in the couple fermentation-pervaporation of whey permeate. *Applied and Microbial Technology* 1993; 40: 470-476.
- [59] Castillo FJ, Izatuirre ME, Mechelena V, Moreno B. Optimization of fermentation conditions for ethanol production from whey. *Biotechnology and Bioengineering* 1982; 4: 567-572.

- [60] Ghaly A, Al-Taweel AA. Continuous ethanol production from cheese whey fermentation by *Candida pseudotropicalis*. *Energy Sources* 1997; 19: 1043-1063.
- [61] Ghaly A, Al-Taweel AA. Effect of nutrient supplements addition of ethanol production from cheese whey using *Candida pseudotropicalis* under batch condition. *Applied Biochemistry and Biotechnology* 1995; 53(2): 107-131.
- [62] Izatuirre ME, Castillo FJ. Selection of lactose-fermenting yeast for ethanol production from whey. *Biotechnology Letters* 1982; 4: 257-262.
- [63] Sucuodrak J, Szewczuk D, Rogalski J, Fiedurek J. Selection of yeast strain and fermentation conditions for high-yield ethanol production from lactose and concentrated whey. *Acta Biotechnologica* 1997; 17: 51-61.
- [64] Fruteau de Lacos H, Membrez Y. Energie à partir de petit-lait: comparaison des filières biogaz et bioéthanol. In: Programme de recherche énergétique, biomasse. Office fédéral de l'énergie (OFEN). Aclens: EREP; 2004.
- [65] Marison IW, Fromentin A, Biollay F, Dauriat A, Lucas-Porta H, Marchand JD, Sarlos G. Caractérisation de filières de production de bioéthanol dans le contexte helvétique. Bern : Office fédéral de l'énergie (OFEN) ; 2000.
- [66] Marison IW, Fromentin A, Biollay F, Dauriat A, Lucas-Porta H, Marchand JD, Sarlos G. Caractérisation de filières de production de bioéthanol dans le contexte helvétique: Annexes au rapport. Bern : Office fédéral de l'énergie (OFEN) ; 2000.

Chapter 6

Mixed-culture fermentation of
non-sterile whey permeate

1. Abstract

A mixed-culture, able to produce ethanol as main fermentation product, was isolated from spontaneous fermenting whey. The microorganisms present in this mixed-culture were identified to be *Kluyveromyces marxianus* (S1), *Issatchenkia orientalis* (S2), and *Enterococcus faecalis* (S3). Comparison of fermentation of non-sterilized whey by *K. marxianus* (S1) alone or by a reconstituted consortium of *K. marxianus* (S1) and *E. faecalis* (S3) indicated protection by *E. faecalis* (S3) against lactic acid bacteria present in non-sterilized whey without negatively influencing ethanol production. The highest ethanol performance parameters were obtained using the mixed-culture, grown at pH 4 and 30°C, with an ethanol production yield of 0.65 C-mol ethanol /C-mol lactose and a volumetric productivity of 1.85 g ethanol/(L·h). At 37°C and pH>4.0, lactate fermentation became important and thus reduced significantly the ethanol production yield.

This chapter was submitted for publication in *Enzyme and Microbial Technology* de Glutz FN, Hugonnet M, Oertlé E, Holliger C, Marison IW. Mixed-culture fermentation of non-sterile whey permeate

2. Introduction

Kluyveromyces marxianus is a Crabtree-negative, lactose-utilizing yeast. Several strains have generally-regarded-as-safe status ensuring that large-scale utilization of this strain is facilitated by regulatory agencies [1, 2]. *K. marxianus* species have been isolated from a large variety of habitats due to their wide metabolic diversity and substantial degree of intraspecific polymorphism with other yeast strains [3-9]. As a consequence, several biotechnological applications of these yeast have been reported [10]: production of enzymes, such as β -galactosidase [11-13], inulinase [14-16], polygalacturonases [17-19] and β -glucosidase [20, 21]; aroma compounds [22-24]; single-cell protein [25] and ethanol [26-30]. In the latter case considerable effort was dedicated to high-temperature [31-33] and simultaneous saccharification-fermentation processes [34-36]. Other applications of *K. marxianus* include the reduction of lactose content in food products [12], the production of bio-ingredients from cheese whey [12, 13] and bioremediation when producing anticholesterolemic agents [37].

Issatchenkia orientalis is a thermophylic variant of *Candida krusei* naturally present in animals [38]. Several yeasts belonging to the genus *Candida* and *Pichia* such as *Candida santamariae*, *Candida lambica*, *Candida krusei*, *Pichia farinosa*, *Pichia fermentans* and *Pichia stipitis* are known to produce ethanol from glucose [39-44]. *I. orientalis* is mainly studied with relation to wine related fields [39-45] since, according to the taxonomical study of yeasts [46], this strain ferments glucose to produce ethanol and is able to assimilate succinic acid and lactose, an ability which differentiates it from *Saccharomyces cerevisiae* [38]. Other applications of *I. orientalis* are related to degradation of malic acid [45], production of key intermediates for the pharmaceutical industry, such as L-phenyl acetyl carbinol [47], and wastewater treatment [48].

The first description of *Enterococcus* was reported in 1899 by Thiercelin who characterized it as Gram-positive bacteria from intestinal origin [49]. In 1980 this spherical shaped bacterium, very similar to *Streptococcus faecalis*, was named *Enterococcus faecalis*. This class of bacteria has been used to produce lactic acid [50-52] or fumarate reduction. From a medical point of view, *E. faecalis* detection can be used to indicate the presence of pathogenic bacteria and can lead to diseases [51] but the use of dead cells has also been reported to be efficient as a cancer treatment [53].

The aim of the present work is to characterize ethanol production by a consortium of these strains, one bacterium and two yeasts, isolated from spontaneous fermenting whey [54-58]. The rationale behind this was to take advantage of the high fermentative activity of *K.*

marxianus combined with the ethanol tolerance of *I. orientalis* [57]. Another potential advantage of this co-culture is the production by *E. faecalis* of a substance, as yet non-identified, active against numerous gram-positive as well as gram-negative bacteria, which may help to avoid bacterial contamination during the fermentative process [58], particularly when the ethanol concentration in the medium is low. *I. orientalis* is a flocculating yeast and this characteristic might be important for the continuous production of ethanol since a high concentration of cells can be maintained within the fermentor without the aid of immobilizing agents.

3. Materials and Methods

3.1 Microorganisms, inocula preparation and media

A stable mixed-culture was isolated from a Swiss dairy and determined to be composed of two yeasts and one bacterium which produced ethanol at efficient levels. The yeast species were identified to be *Kluyveromyces marxianus* (S1) and *Issatchenkia orientalis* (S2), and the bacterium, *Enterococcus faecalis* (S3). A consortium of these three organisms (CEKI-*Consortium E. faecalis, K. marxianus, I. orientalis*) was characterized for ethanol production from whey permeate. Stock cultures were stored as a suspension in 9 g/L NaCl and 10 g/L glycerol at -80°C. Cells were re-activated in a 1-liter baffled shake-flasks containing 100 mL YPL medium at 30°C for 24h. Two cultures, in baffled shake-flasks of 100 mL each, were used to prepare the inocula. After 24 h at 30°C, the two precultures were centrifuged (10 minutes at 1500 g) at 4°C and the cell pellets resuspended in 10 mL sterile water and used immediately. YPL medium contained 40 g/L lactose, 6 g/L yeast extract (Oxoid, Hampshire, England) and 5 g/L Bacto™Peptone (Becton, Le Pont de Claix, France) and sterilized by filtration (0.22 µm, Steriltop, Millipore Corporation, Billerica, USA).

Isolation of the organisms comprising the microbial consortium culture was done by harvesting 100 µL of samples from the flask harvests followed by dilution (10⁶- fold), spreading on solid medium (Plate-Count Agar, Merck, Germany) and incubation at 37°C for 48h. Identification of the organisms comprising the consortium was performed by DSMZ (Deutsche Sammlung von Microorganismen und Zellkulturen, Braunschweig, Germany), which characterized them based on morphological and physiological criteria.

The culture medium used for ethanol production was whey permeate powder (Cremo, Villars-sur-Glâne, Switzerland) reconstituted to 40 g/L, completed with 3.75 g/L yeast extract (Oxoid, Hampshire, England) to avoid nitrogen limitation, pasteurized at 65°C for 30 min, then quickly cooled to 37°C immediately prior to inoculation. Cell density was determined spectrophotometrically by measuring optical density at 600nm (OD₆₀₀).

Assessment of population stability was done by comparing cell-bank mixed-cultures with long term cultures. The latter were obtained by harvesting cell-bank mixed-cultures in 1-liter shake-flasks containing 300 mL YPL medium at 30°C. Every 24 h 1:5 of the produced biomass was centrifuged and introduced to fresh YPL medium for over 96 hours.

3.2 Culture conditions

Shake-flask cultures were performed in 250 mL Erlenmeyer flasks stirred with a magnetic stirrer at 200 rpm in temperature controlled conditions. Bioreactor fermentation experiments were undertaken using a 2-liter Bio-Engineering system (1.5 L working volume, Bio-Engineering AG, Wald, Switzerland) operating at an agitation rate of 500 rpm. Temperature was monitored by a regulating system and automatic addition of NaOH 3M was utilized to maintain pH. A polarographic pO₂ probe (InPro 6800, Mettler Toledo, Greifensee, Switzerland) was used to monitor dissolved oxygen, with respect to air saturated medium. pO₂ was maintained below 3% by gassing with nitrogen in order to ensure anaerobic conditions. Initial biomass concentration was fixed to 1 g/L for all cultures.

3.3 Reagents and metabolite analysis

Lactose, acetic acid and ethanol concentrations were determined by HPLC analysis (1100 series, Agilent Technologies, Palo Alto, USA). An ion exchange chromatography column (Supelcogel H, 30 cm x 4.6 mm; 9µm, Supelco, Bellefonte, USA) was used at 60°C. A 0.005 M H₂SO₄ solution in ultrapure water was applied at a constant eluent flow rate of 0.6 mL/min. Metabolites were measured using an IR-refractive index detector.

4. Results and Discussion

4.1 Identification of strains present in a whey-fermenting mixed-culture

A number of samples were taken from different cheese industries and cultivated separately in order to identify and isolate characteristic microorganisms contaminating milk and whey. Various morphological types of bacteria could be observed through microscopic examination, of which some species were present in whey as lactic ferments added artificially during the cheese making process. In some cases yeast cells were also present that apparently grew as mixed-cultures with bacteria.

Preliminary shake-flask cultures showed that one of these mixed-cultures produced ethanol at promising levels. Subsequent batch cultures on whey permeate in a bioreactor, operated at 37°C and pH 6, resulted in an ethanol production yield ($Y_{P/S}$) of 0.432 C-mol/C-mol, a result similar to pure cultures of direct fermentation yeasts reported in the literature [28, 58-61], and obtained with *K. marxianus* CBS 397 in chapter 5.

Microscopic examination of one sample of fermented whey showed cells of various sizes and shapes characteristic of bacteria and yeasts. Subsequent isolation and identification by DSMZ (Table 1) revealed that this mixed culture contained two yeast strains (a) *Kluyveromyces marxianus* van der Walt (S1) and (b) *Issatchenkia orientalis* Kudryavzev (S2) and one bacterial strain (c) *Enterococcus faecalis* (S3).

Table 1. Morphological and physiological interpreted by DSMZ for identifying the microorganisms comprising the isolated mixed-culture: (a) *Kluyveromyces marxianus* (S1), (b) *Issatchenkia orientalis* (S2) and (c) *Enterococcus faecalis* (S3).

(a) Identification: <i>Kluyveromyces marxianus</i> van der Walt				
Colony on potato dextrose agar appeared to be cream-coloured and butyrous. Absence of Blastospores globose-ellipsoidal, pseudomycelium and true mycelium.				
Utilization of C sources				
anaerobic	Glucose	+		
aerobic	Glucose	+	α -methylglucoside	-
	Galactose	+	Salicin	-
	Sorbose	-	Cellobiose	-
	Rhamnose	-	Maltose	-
	Dulcitol	-	Lactose	+
	Inositol	-	Melibiose	-
	Mannitol	+	Sucrose	+
	Sorbitol	+	Trehalose	-
	Glycerol	+	Inulin	+
	Erythritol	-	Melezitose	-
	D-Arabinose	-	Raffinose	+
	L-Arabinose	+	Starch	-
	Ribose	-	Xylitol	-
	D-Xylose	+	Gluconate	-
	L-Xylose	-	2-keto-Gluconate	-
	Adonitol	+	5-keto-Gluconate	-
Additional tests				
Growth with N- acetylgluconamine -				

(b) Identification: <i>Issatchenkia orientalis</i> Kudryavzev				
Formed colony on potato dextrose agar hyaline. Absence of Blastospores globose-ellipsoidal, pseudomycelium and true mycelium. No sexual reproduction was detected				
Utilization of C sources				
anaerobic	Glucose	+		
aerobic	Glucose	+	α -methylglucoside	-
	Galactose	-	Salicin	-
	Sorbose	-	Cellobiose	-
	Rhamnose	-	Maltose	-
	Dulcitol	-	Lactose	-
	Inositol	-	Melibiose	-
	Mannitol	-	Sucrose	-
	Sorbitol	-	Trehalose	-

	Glycerol	+	Inulin	-
	Erythriol	-	Melezitose	-
	D-Arabinose	-	Raffinose	-
	L-Arabinose	-	Starch	-
	Ribose	-	Xylitol	-
	D-Xylose	-	Gluconate	-
	L-Xylose	-	2-keto-Gluconate	-
	Adonitol	-	5-keto-Gluconate	-
Additional tests				
Growth with N-acetylgluconamine		+		
Growth at 40°C		+		

(c) Identification: <i>Enterococcus faecalis</i>				
Cocci		+		
Diameter		1.2-1.5 µm		
Acid from	Trehalose	+	Melibiose	-
	Mannitol	+	Sorbitol	+
	Raffinose	-	Melezitose	+
	Lactose	+	L-Rhamnose	-
	Ribose	+	Cellobiose	+
	Saccharose	+	Mannose	+
	Arabinose	-	Inositol	-
	Urease	-	Growth at 45°C	+
	Voges	+	Growth at 50°C	-
	KOH	-	β-galactosidase	-
	Oxidase	-	Alcaline Phosphatase	-
	Gram-reaction	+	Aminopeptidase	-
Mass spectroscopy				
The profile of the cellular fatty acids contents the typical components for <i>Enterococcus</i> .				
The partial sequences have shown a similarity of 99.8% to <i>Enterococcus faecalis</i> . The physiological tests confirm this result.				

4.2 Characterization of whey fermentation by mixed-culture

4.2.1 Temperature optimum

Parallel batch cultures of the mixed-culture CEKI in 40 g/L whey permeate were performed at four temperatures, varying from 20°C to 37°C, and pH 6, in order to determine the influence of temperature on ethanol production yield and lactate production yield ($Y_{L/S}$). The results obtained (Table 2) show that temperature plays a crucial role in lactic acid production and thus directly influences ethanol production performance. Up to 30°C, ethanol was the major fermentation product of this mixed-culture reaching maximal ethanol production at 30°C within 22 h. However, ethanol production yield and selectivity decreased dramatically at 37°C indicating the crucial role that temperature plays in ethanol production performance by CEKI. The selectivity for ethanol compared to lactic acid is above 98% when fermentation is carried out at 30°C, while the same mixed-culture at 37°C has a selectivity of 47%.

Table 2. Characterization of ethanol production from whey permeate with mixed-culture CEKI, composed of *K. marxianus* (S1), *I. orientalis* (S2) and *E. faecalis* (S3) grown at different temperatures in 250 mL shake-flasks.

Temperature °C	$Y_{P/S}$ C-mol·C-mol ⁻¹	$Y_{L/S}$ C-mol·C-mol ⁻¹	ethanol g·L ⁻¹	t^1 h ⁻¹	$Y_{P/S}/Y_{L/S}$ -
20	0.64	0.02	19.4	49	32
25	0.61	0.04	18.7	29	15
30	0.62	0.01	19.7	22	62
37	0.44	0.23	14.2	23	1.9

¹ Time needed to ferment 40 g L⁻¹ lactose

While ethanol production performance was shown to be relatively constant from 20-30°C the duration of the batch culture is strongly temperature dependent. At 20°C, total lactose consumption, and thus final ethanol concentration, was reached after 49 hours. Fermentation time was reduced from 49 to 22 h by increasing the temperature to 30°C which, combined with the high ratio of $Y_{P/S}/Y_{L/S}$, indicates that the optimal temperature for this mixed-culture growing on whey permeate was 30°C.

4.2.2 pH optimum

The results depicted in Figure 1 clearly show that pH also played an important role in ethanol fermentation from whey by the mixed-culture. The lactic acid yield decreased from 0.13 C-mol/C-mol at pH 6 to 0.043 C-mol/C-mol at pH 4. Under these optimized conditions (30°C and pH 4) a maximal ethanol yield of 0.65 C-mol/C-mol was measured and total lactose consumption was observed after 14 hours of cultivation.

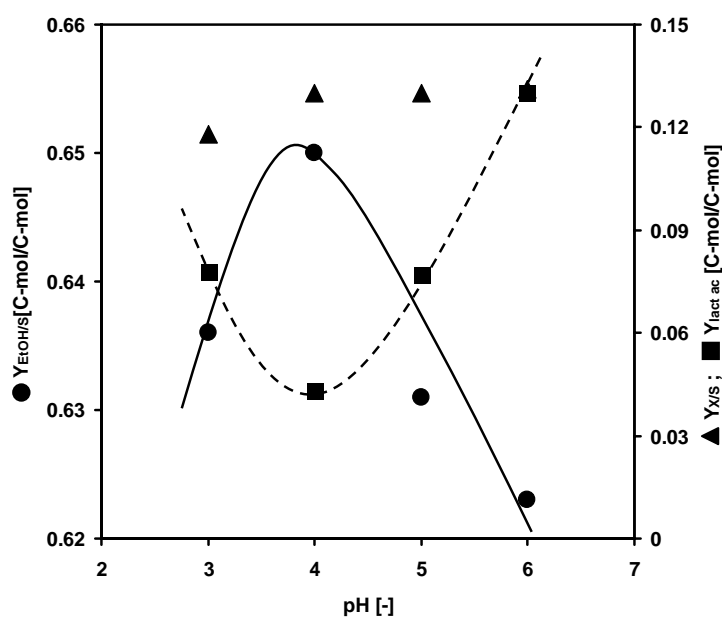

Figure 1. Dependency of ethanol performance parameters on pH for the mixed-culture CEKI, composed of *K. marxianus* (S1), *I. orientalis* (S2) and *E. faecalis* (S3). These cultures were performed at 30°C in 250 mL shake-flasks.

4.2.3 Stability of ethanol fermentation performance

Since the microbial consortium CEKI isolated in this work is composed of a bacterium and two yeast strains, competition for the carbon source consumption might reveal a dominance of one or more of these organisms after a longer cultivation period. Thus the ethanol production performance of the mixed-culture cell-bank was compared to a new equilibrium consortium which was obtained by harvesting cell-bank inocula for 96 hours at 30°C anaerobically.

The stable consortium was compared to the results of cell-bank cultures. The data presented in Figure 2 show that the ethanol yield remained constant as a function of both temperature and age, thereby suggesting that the composition of CEKI remained stable. This was confirmed by microscopic examination and enumeration.

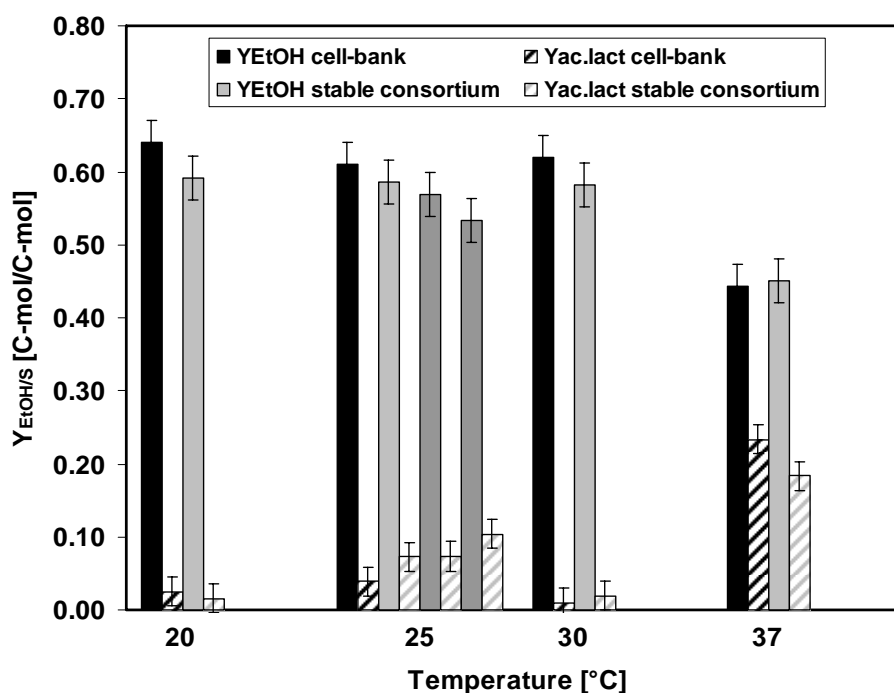

Figure 2. Comparison of ethanol production yields of CEKI, composed of *K. marxianus* (S1), *I. orientalis* (S2) and *E. faecalis* (S3), grown in 250 mL shake-flasks at different temperatures with cell-bank inocula and stabilized consortia.

4.2.4 Fermentation performance parameters under optimal conditions

To determine the performance parameters of this microbial consortium under optimal growth conditions, batch cultures were performed at 30°C and pH 4. The profile of the biomass production curve (Figure 3) suggests that no substrate or product inhibition were observed, thus enabling the measurement of maximal performance parameters (Table 3).

Comparing these values with those of *K. marxianus* CBS 5795 growing in batch culture on 40g/L whey permeate under similar conditions (chapter 3), show that the main difference was the time of fermentation for reaching total consumption of the lactose. Thus for CBS 5795 the fermentation lasted 22 hours, if the lag phase is neglected, while only 14 hours were needed for achieving the same result with CEKI. In both cases initial biomass was set to 1 g/L but an almost three times higher μ_{\max} was measured for the mixed-culture.

Chapter 5 presented the kinetics of eight ethanol producing yeasts. A comparison of the ethanol production performance of the mixed-culture with direct fermentation yeast shows that $Y_{P/S}$ is very similar but $Y_{X/S}$ and μ_{\max} are lower for the direct fermentation yeasts. Since

the growth profile was exponential during the major part of the fermentation period (Figure 3), it can be deduced that no substrate or product inhibition affected the mixed-culture. Comparison of productivity values is more delicate since the initial biomass concentration was 5 g/L in bioreactor batch cultures with direct fermentation yeasts compared to 1 g/L for mixed-culture experiments.

Average ethanol productivity ($Q_{p,overall}$) of the mixed-culture was 1.39 g/(L·h) and maximal ethanol productivity 1.85 g/(L·h). These data are approximately 3-fold lower than the productivity of direct fermentation yeasts, although the initial inoculation density was five times lower. If the results are related to cell number the mixed-culture shows an approximately 50% higher productivity than for *Kluyveromyces marxianus*, CBS 6432, CBS 397 and CBS 5795.

Table 3. Ethanol fermentation parameters of the mixed-culture CEKI, composed of *K. marxianus* (S1), *I. orientalis* (S2) and *E. faecalis* (S3). Cultures were performed in a 1.5-liter bioreactor grown on whey permeate at 30°C and pH 4.

Parameter			Units
Ethanol production yield	$Y_{P/S}$	0.65	C-mol·C-mol ⁻¹
	$Y_{P/S}$	0.52	g·g ⁻¹
Lactate production yield	$Y_{L/S}$	0.043	C-mol·C-mol ⁻¹
	$Y_{L/S}$	0.045	g·g ⁻¹
Biomass production yield	$Y_{X/S}$	0.13	C-mol·C-mol ⁻¹
	$Y_{X/S}$	0.12	g·g ⁻¹
Growth rate	μ_{max}	0.14	h ⁻¹
Fermentation period ¹	t	14	h
Ethanol production rate ²	$Q_{p, overall}$	1.39	g·L ⁻¹ ·h ⁻¹
Maximal ethanol production rate	$Q_{p, max}$	1.85	g·L ⁻¹ ·h ⁻¹
Maximal ethanol concentration	$c_{EtOH,max}$	55	g·L ⁻¹

¹ Time needed to ferment 40 g L⁻¹ lactose

² Overall ethanol production from inoculation until total consumption of lactose

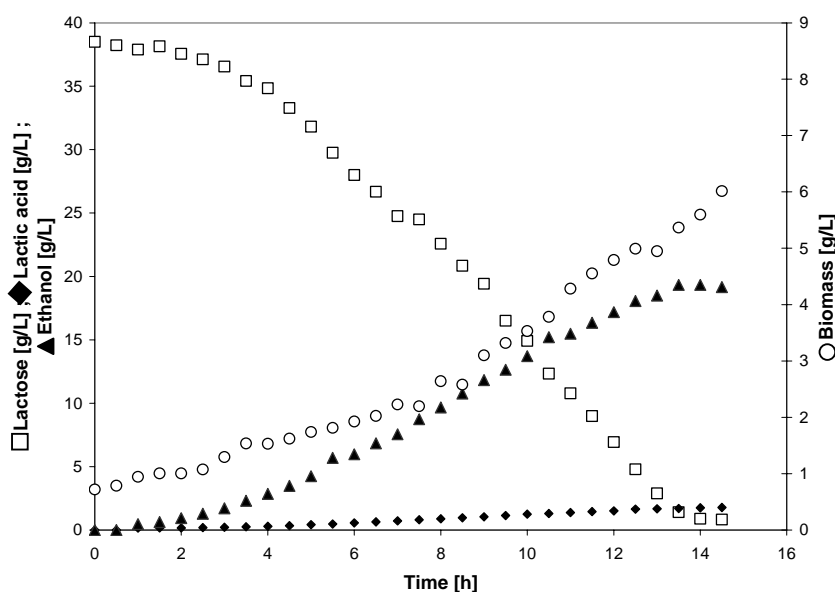

Figure 3. Kinetics of ethanol production of the mixed-culture CEKI, composed of *K. marxianus* (S1), *I. orientalis* (S2) and *E. faecalis* (S3). This cultures was performed in a 1.5-liter bioreactor grown on 40 g/L lactose whey permeate at 30°C and pH 4.

4.3 Whey fermentation by pure cultures of the mixed-culture isolates

The microbial consortium studied is composed of three microorganisms: two yeasts, *K. marxianus* and *I. orientalis*; and one bacterium *E. faecalis*. In order to understand the role of each organisms, the ethanol production performance of the individual organisms was determined. *E. faecalis* alone was not able to grow on whey permeate indicating that this bacterium lacks the property to hydrolyze lactose.

4.3.1 Whey fermentation by *K. marxianus* (S1)

Kluyveromyces marxianus is well known for ethanol production from whey and whey permeate. Very high production yields and good tolerance to the product usually characterize this yeast. For the strain isolated from CEKI, ethanol performance parameters are reported in Table 4. Biomass yield ($Y_{X/S}$) was 0.14 C-mol/C-mol, which is almost identical to the value measured with the consortium. With respect to the ethanol yield ($Y_{P/S}$), *K. marxianus* (S1) demonstrated a slightly lower value (0.63 C-mol/C-mol) compared to the mixed-culture (0.650 C-mol/C-mol). *K. marxianus* (S1) produced less than 0.7% of lactic acid, while ethanol productivities were also in comparable range of values (approximately 10% lower) than for CEKI.

Table 4. Performance parameters of *K. marxianus* (S1). Cultures were performed in a 1.5-liter bioreactor grown on whey permeate at 30°C and pH 4.

Parameter			Units
Ethanol production yield	$Y_{P/S}$	0.63	C-mol·C-mol ⁻¹
	$Y_{P/S}$	0.51	g·g ⁻¹
Lactate production yield	$Y_{L/S}$	0.067	C-mol·C-mol ⁻¹
	$Y_{L/S}$	0.070	g·g ⁻¹
Biomass production yield	$Y_{X/S}$	0.13	C-mol·C-mol ⁻¹
	$Y_{X/S}$	0.12	g·g ⁻¹
Growth rate	μ_{\max}	0.14	h ⁻¹
Fermentation period ¹	t	14	h
Ethanol production rate ²	$Q_{p, \text{overall}}$	1.37	g·L ⁻¹ ·h ⁻¹
Maximal ethanol production rate	$Q_{p, \text{max}}$	1.75	g·L ⁻¹ ·h ⁻¹
Maximal ethanol concentration	$c_{\text{EtOH, max}}$	48	g·L ⁻¹

¹ Time needed to ferment 40 g L⁻¹ lactose

² Overall ethanol production from inoculation until total consumption of lactose

4.3.2 Whey fermentation by *I. orientalis* (S2)

Pure culture fermentations by *I. orientalis* (S2) demonstrated reasonable ethanol production characteristics. Compared with the corresponding values obtained with *K. marxianus* (S1), the final biomass concentration was 20% higher (Table 5) and the final ethanol concentration 10% higher, indicating a higher ethanol tolerance. When the fermentation stopped, the presence of available sugar pointed to an inhibition of the cell activity due to ethanol (54 g/L). The yield was 0.59 C-mol ethanol /C-mol lactose when cultivated at 30°C and pH 4, a value about 11% lower than the one reported for *K. marxianus* (S1). Less lactic acid (35%) was produced compared to *K. marxianus* (S1), characterized by a yield of 0.044 C-mol/ C-mol. Growth of *I. orientalis* (S2) was 50% slower than for *K. marxianus* (S1) and as a consequence fermentation time was significantly increased from 14 to 18 hours, thus reducing ethanol global productivity by 40% and maximum productivity by 60% compared to cultures of *K. marxianus* (S1) (Table 5).

Table 5. Performance parameters of *I. orientalis* (S2). Cultures were performed in a 1.5-liter bioreactor grown on whey permeate at 30°C and pH 4.

Parameter			Units
Ethanol production yield	$Y_{P/S}$	0.59	C-mol·C-mol ⁻¹
	$Y_{P/S}$	0.48	g·g ⁻¹
Lactate production yield	$Y_{L/S}$	0.044	C-mol·C-mol ⁻¹
	$Y_{L/S}$	0.046	g·g ⁻¹
Biomass production yield	$Y_{X/S}$	0.17	C-mol·C-mol ⁻¹
	$Y_{X/S}$	0.16	g·g ⁻¹
Growth rate	μ_{\max}	0.067	h ⁻¹
Fermentation period ¹	t	18	h
Ethanol production rate ²	$Q_{p, \text{overall}}$	0.932	g·L ⁻¹ ·h ⁻¹
Maximal ethanol production rate	$Q_{p, \text{max}}$	1.11	g·L ⁻¹ ·h ⁻¹
Maximal ethanol concentration	$c_{\text{EtOH, max}}$	54	g·L ⁻¹

¹ Time needed to ferment 40 g L⁻¹ lactose

² Overall ethanol production from inoculation until total consumption of lactose

4.4 Fermentation of non-sterilized whey permeate by a reconstituted consortium of *K. marxianus* and *E. faecalis*

The presence of *E. faecalis* (S3) in CEKI isolated from spontaneously fermenting whey despite the fact that this bacterium is not able use lactose directly indicates that this bacterium fulfills a certain role in the consortium, possibly a protective one against bacterial contaminants. In order to test this hypothesis, non-sterilized whey permeate was fermented in shake-flasks with a reconstituted consortium containing *K. marxianus* (S1) and *E. faecalis* (S3), and the results were compared to pure cultures of *K. marxianus* (S1). The maximal ethanol concentration obtained with the mixed-culture was comparable to one obtained previously with pasteurized whey permeate, and 30% higher compared to batch culture with only *K. marxianus* (S1) (Figure 4).

The specific production of lactic acid increased by a factor of 5 in the pure culture fermentation compared to the reconstituted mixed-culture, indicating growth and fermentation by lactic acid bacteria present in non-sterilized whey permeate. This result suggested that *E. faecalis* (S3) had an inhibiting effect on the growth of undesired lactic acid bacteria present in non-sterilized whey permeate and thus led to an optimal ethanol fermentation of raw whey permeate.

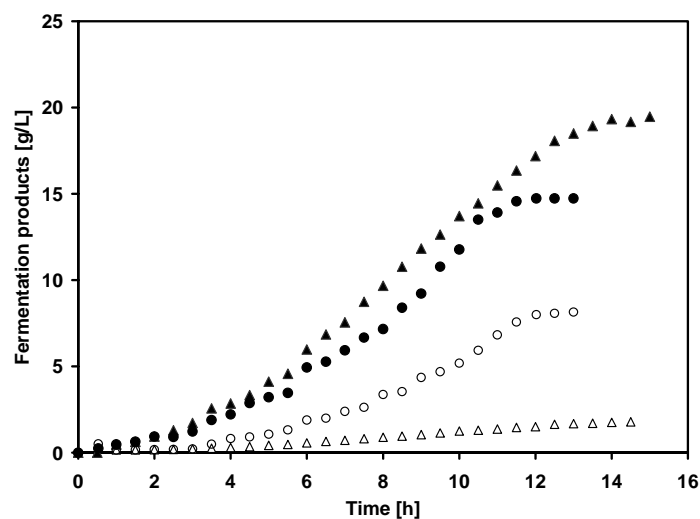

Figure 4. Fermentation of raw non-sterilized whey permeate by a reconstituted mixed-culture of *K. marxianus* (S1) and *E. faecalis* (S3) (triangles) and by *K. marxianus* (S1) alone (circles) cultivated in 250 mL shake-flasks at 30°C and pH 4, showing the production of ethanol (closed symbols) and lactic acid (open symbols).

5. Conclusions

In this work it was shown that CEKI comprising *Kluyveromyces marxianus* (S1), *Issatchenkia orientalis* (S2) and *Enterococcus faecalis* (S3) enhanced the global fermentative process compared to pure cultures of this consortium. The main parameters considered for the comparison of pure and mixed-culture fermentations, such as ethanol production yield and volumetric productivity of the system, were higher in the consortium cultures compared with those obtained using pure cultures. The ethanol yield of CEKI was 0.65 C-mol ethanol/C-mol lactose, which is very similar to pure cultures of *K. marxianus* (S1) (0.63 C-mol/ C-mol) and slightly higher than for *I. orientalis* (S2) (0.59 C-mol/ C-mol). The yields reported with pure cultures of yeasts are typically in the range of 0.60 C-mol ethanol/ C-mol lactose [28, 58-61] which is lower than the yields obtained in this work, but comparable results have already been reported by Ghaly [62-63] and Ozmihci [64], on whey as fermentation medium, with respectively *C. pseudotropicalis* and *K. marxianus*. The other measured parameters, $Q_{p,global}$, $Y_{X/S}$ and $Y_{L/S}$ of CEKI were also very similar to pure culture of *K. marxianus* (S1) suggesting that *K. marxianus* (S1) is mainly responsible for ethanol production. *I. orientalis* (S2) enables to reach higher final ethanol concentration, thus reducing energy costs for ethanol purification by 10%. However, the main advantage of this mixed-culture consists in its protective properties, which enable new production strategies because fermentation procedure requires the control of many operating conditions. While efforts were undertaken to ensure stabilization of the substrate until a centralized treatment center, fermentation at the production site seems to be possible without expensive control equipment and specific know-how of the operators.

6. Nomenclature

EtOH	Ethanol	
n_i	Number of moles of substance i	C-mol
Q_P	Volumetric ethanol production rate	$\text{g}\cdot\text{L}^{-1}\cdot\text{h}^{-1}$
t	Time	h
T	Temperature	$^{\circ}\text{C}$
X	Cell dry weight	$\text{g}\cdot\text{L}^{-1}$
$Y_{j/i}$	Yield coefficient of substance j on substance i	$\text{C}\cdot\text{mol}\cdot\text{C}\cdot\text{mol}^{-1}$ $\text{g}\cdot\text{g}^{-1}$
YPL	Yeast extract-Peptone-Lactose rich medium	
μ	Specific growth rate	h^{-1}
CEKI	Consortium of <i>E. faecalis</i> (S3) <i>K.</i> <i>marxianus</i> (S1) and <i>I. orientalis</i> (S2)	

Subscripts

global	Overall mean value
i	Refers to compound i
j	Refers to compound j
L	Refers to the produced lactic acid
max	Maximal
P	Refers to the produced ethanol
S	Refers to limiting nutrient
X	Refers to biomass

7. References

- [1] Medeiros ABP, Pandey A, Freitas RJS, Christen P, Soccol CR. Optimization of the production of aroma compounds by *Kluyveromyces marxianus* in solid-state fermentation using factorial design and response surface methodology. *Biochemistry Engineering Journal* 2000; 6: 33-39.
- [2] Medeiros ABP, Pandey A, Christen P, Fontoura PSG, de Freitas RJS, Soccol CR. Aroma compounds produced by *Kluyveromyces marxianus* in solid state fermentation on a packed bed column bioreactor. *World Journal of Microbiology and Biotechnology* 2001; 17: 767-771.
- [3] van der Walt JP. *Kluyveromyces*- a new yeast genus of the Endomycetales. *Antonie van Leeuwenhoek* 1956; 22: 265-272.
- [4] van der Walt JP. *Kluyveromyces* van der Walt emend. van der Walt. In: Lodder J (eds) *The yeasts: a taxonomic study*, 2nd edn. NHPC, Amsterdam; 1970: p 316-378.
- [5] Kurtzman CP, Fell JW. (eds) *The yeasts: a taxonomic study*, 4th edn. Elsevier, Amsterdam; 1998.
- [6] Kurtzman CP, Robnett CJ. Phylogenetic relationships among yeasts of the 'Saccharomyces complex' determined from multigene sequence analyses. *FEMS Yeast Research* 2003; 3: 417-432.
- [7] Lachance MA. *Kluyveromyces* van der Walt emend. van der Walt. In: Kurtzman CP, Fell JW (eds) *The yeasts: a taxonomic study*, 4th edn. Elsevier, Amsterdam; 1998: p 227-247.
- [8] Lachance MA. Current status of *Kluyveromyces* systematic. *FEMS Yeast Research* 2007; 7: 642-645.
- [9] Kreger-van Rij NJW. *The yeasts: a taxonomic study*, 3rd edn. Elsevier, Amsterdam; 1984.
- [10] Fonseca GG, Henzle E, Wittmann C, Gombert AK. The yeast *Kluyveromyces marxianus* and its biotechnological potential. *Applied Microbial Biotechnology* 2008; 79: 339-354.
- [11] Rajoka MI, Khan S, Shahid R. Kinetics and regulation studies of the production of β -galactosidase from *Kluyveromyces marxianus* grown on different substrates. *Food Technology and Biotechnology* 2003; 41: 315-320.
- [12] Furlan SA, Schneider ALS, Merkle R, Carvalho-Jonas MD, Jonas R. Formulation of a lactose-free, low-cost culture medium for the production of β -D-galactosidase by *Kluyveromyces marxianus*. *Biotechnology Letters* 2000; 22: 589-593.
- [13] Fiedurek J, Szczodrak J. Selection of strain, culture conditions and extraction procedures for optimum production of β -galactosidase from *Kluyveromyces fragilis*. *Acta Microbiologica Polonica* 1994; 43: 57-65.
- [14] Cruz-Guerrero A, García-Peña I, Bárzana E, García-Garibay M, Gómez-Ruiz L. *Kluyveromyces marxianus* CDBB-L-278: a wild inulinase hyperproducing strain. *Journal of Fermentation Bioengineering* 1995; 80: 159-163.
- [15] Hensing M, Vrouwenvelder H, Hellinga C, Baartmans R, van Dijken JP. Production of extracellular inulinase in high-cell density fed-batch cultures of *Kluyveromyces marxianus*. *Applied Microbiology and Biotechnology* 1994; 42: 516-521.

- [16] Pessoa Jr A, Vitolo M. Inulinase from *Kluyveromyces marxianus*: culture medium composition and enzyme extraction. Brazilian Journal of Chemical Engineering 1999; 6: 237-245.
- [17] Harsa S, Zaror CA, Pyle DL. Production of polygalacturonases from *Kluyveromyces marxianus* fermentation-preliminary process design and economics. Process Biochemistry 1993; 28: 187-195.
- [18] Garcia-Garibay M, Torres J, López-Munguía-Canales A, Casas LT. Influence of oxygen transfer rate on β -galactosidase production from *Kluyveromyces marxianus*. Biotechnology Letters 1987; 9: 417-420.
- [19] Donaghy JA, McKay AM. The use of *Kluyveromyces fragilis* for the extraction of orange peel pectin. Journal of Applied Bacteriology 1994; 76: 506-510.
- [20] Leclerc M, Chemardin P, Arnaud A, Ratomahenina R, Galzy P, Gerbaud C, Raynal A, Guerineau M. Comparison of the properties of the purified beta-glucosidase from the transformed strain of *Saccharomyces cerevisiae* TYKF2 with that of the donor strain *Kluyveromyces fragilis* Y610. Biotechnology and Applied Biochemistry 1987; 9: 410-422.
- [21] Raynal A, Guerineau M. Cloning and expression of the structural gene for β -glucosidase of *Kluyveromyces fragilis* in *Escherichia coli* and *Saccharomyces cerevisiae*. Molecular and General Genetics 1984; 195: 108-115.
- [22] Scharpf LG, Seitz EW, Morris JA, Farbood MI. Generation of flavor and odor compounds through fermentation processes. In: Parliament TH, Croteau R (eds) Biogenesis of aroma, American Chemical; 1986.
- [23] Leclercq-Perlat MN, Corrieu G, Spinnler HE. Comparison of volatile compounds produced in model cheese medium deacidified by *Debaryomyces hansenii* or *Kluyveromyces marxianus*. Journal of Dairy Science 2004; 87: 1545-1550.
- [24] Fabre CE, Duviau VJ, Blanc PJ, Goma G. Identification of volatile flavour compounds obtained in culture of *Kluyveromyces marxianus*. Biotechnology Letters 1995; 17: 1207-1212.
- [25] van Ooyen AJ, Dekker P, Huang M, Olsthoorn MM, Jacobs DI, Colussi PA, Taron CH. Heterologous protein production in the yeast *Kluyveromyces lactis*. FEMS Yeast Research 2006; 6: 381-392.
- [26] Grubb CF, Mawson AJ. Effects of elevated solute concentrations on the fermentation of lactose by *Kluyveromyces marxianus* Y-113. Biotechnology Letters 1993; 15: 621-626.
- [27] Barron N, Marchant R, McHale L, McHale AP. Ethanol production from cellulose at 45°C using a batch-fed system containing alginate-immobilized *Kluyveromyces marxianus* IMB3. World Journal of Microbiology and Biotechnology 1996; 12: 103-104.
- [28] Ferrari MD, Loperena L, Varela H. Ethanol production from concentrated whey permeate using a fed-batch culture of *Kluyveromyces fragilis*. Biotechnology Letters 1994; 16: 205-210.
- [29] Gough S, Barron N, Zubov AL, Lozinsky VI, McHale AP. Production of ethanol from molasses at 45°C using *Kluyveromyces marxianus* IMB3 immobilized in calcium alginate gels and poly(vinyl alcohol) cryogel. Bioprocess Engineering 1998; 19: 87-90.

- [30] Love G, Gough S, Brady D, Barron N, Nigam P, Singh D, Marchant R, McHale AP. Continuous ethanol fermentation at 45°C using *Kluyveromyces marxianus* IMB3. Immobilized in calcium alginate and kissiris. *Bioprocess Engineering* 1998; 18: 187-189.
- [31] Gough S, Flynn O, Hack CJ, Marchant R. Fermentation of molasses using a thermotolerant yeast, *Kluyveromyces marxianus* IMB3: simplex optimization of media supplements. *Applied Microbiology and Biotechnology* 1996; 46: 187-190.
- [32] Banat IM, Nigam P, Singh D, Marchant R, McHale AP. Ethanol production at elevated temperatures and alcohol concentrations: Part I - Yeasts in general. *World Journal of Microbiology and Biotechnology* 1998; 14: 809-821.
- [33] Ballesteros I, Ballesteros M, Cabanas A, Carrasco J, Martin C, Negro MJ, Saez F, Saez R. Selection of thermotolerant yeasts for simultaneous saccharification and fermentation (SSF) of cellulose to ethanol. *Applied Biochemistry and Biotechnology* 1991; 28: 307-315.
- [34] Kádár ZS, Szengyel ZS, Réczey K. Simultaneous saccharification and fermentation (SSF) of industrial wastes for the production of ethanol. *Industrial Crop Production* 2004; 20: 103-110.
- [35] Ballesteros M, Oliva JM, Manzanares P, Negro MJ, Ballesteros I. Ethanol production from paper material using a simultaneous saccharification and fermentation system in a fedbatch basis. *World Journal of Microbiology and Biotechnology* 2002; 18: 559-561.
- [36] Ballesteros M, Oliva JM, Negro MJ, Manzanares P, Ballesteros I. Ethanol from lignocellulosic materials by a simultaneous saccharification and fermentation process (SFS) with *Kluyveromyces marxianus* CECT 10875. *Process Biochemistry* 2004; 39: 1843-1848.
- [37] Ramirez-Zavala B, Mercado-Flores Y, Hernandez-Rodriguez C, Villa-Tanaca L. Purification and characterization of a lysine aminopeptidase from *Kluyveromyces marxianus*. *FEMS Microbiology Letters* 2004; 235: 369-375.
- [38] Nakayama S, Tomotake M, Negishi H, Ikegami T, Sakaki K, Kitamoto D. *Candida krusei* produces ethanol without production of succinic acid; a potential advantage for ethanol recovery by pervaporation membrane separation. *FEMS Yeast Research* 2008; 8: 706-714.
- [39] Ando H, Ikegami T & Mikata K. Identification and characteristics of the yeast strain isolated from sake lees. *Reports Kyushu National Industrial Research Institute* 1998; 61: 3817-3825.
- [40] Clemente-Jimenez JM, Mingorance-Cazorla L, Martinez-Rodriguez S, Las Heras-Vazquez FJ & Rodriguez-Vico F. Molecular characterization and oenological properties of wine yeasts isolated during spontaneous fermentation of six varieties of grape must. *Food Microbiology* 2004; 21: 149-155.
- [41] Wang R, Dominguez-Espinosa RM, Leonard K, Koutinas A & Webb C. The application of a generic feedstock from wheat for microbial fermentations. *Biotechnology Progress* 2002; 18: 1033-1038.
- [42] Masoud W, Cesar LB, Jespersen L, Jakobsen M. Yeast involved in fermentation of coffee Arabica in East Africa determined by genotyping and by direct denaturing gradient gel electrophoresis. *Yeast* 2004; 21: 549-556.

- [43] Nisiotou AA, Spiropoulos AE, Nychas GJE. Yeast community structures and dynamics in healthy and botrytis-affected grape must fermentations. *Applied and Environmental Microbiology* 2007; 73(21): 6705-6713.
- [44] Manasbaeva AB, Isabaeva SM, Ilyaletdinov AN, Og K. Aggregation of the yeast *Candida krusei*. *Microbiology* 1993; 62(3): 334-338.
- [45] Seo SH, Rhee CH, Park HD. Degradation of malic acid by *Issatchenkia orientalis* KMBL 5774, an acidophilic yeast strain isolated from Korean grape wine pomace. *Journal of Microbiology* 2007; 45(6): 521-527.
- [46] Kurtzman CP & Fell JW. *The Yeasts: A Taxonomic Study*, 4th edn. Elsevier Science Publisher, Amsterdam. 1998.
- [47] Kumar R, Chari A, Narasu L. Production of L-phenyl acetyl carbine (L-PAC) by different novel strains of yeast in molasses in sugar cane juice as production medium. *Research Journal of Microbiology* 2006; 1(5): 433-437.
- [48] Tondee T, Sirianuntapiboon S, Ohmomo S. Decolorization of molasses wastewater by yeast strain, *Issatchenkia orientalis* No. SF9-246. *Bioresource Technology* 2008; 99: 5511-5519.
- [49] Rince A, Flahaut S, Auffray Y. Identification of general stress genes in *Enterococcus faecalis*. *International Journal of Food Microbiology* 2000; 55: 87-91.
- [50] Van Hoorde K, Verstraete T, Vandamme P, Huys G. Diversity of lactic acid bacteria in two Flemish artisan raw milk Gouda-type cheeses. *Food Microbiology* 2008; 25: 929-935.
- [51] Wee AJ, Yun JS, Kim D, Ryu HW. Batch and repeated batch production of L(+)-lactic acid by *Enterococcus faecalis* RKY1 using wood hydrolyzate and corn steep liquor. *Journal of Industrial Biotechnology* 2006; 33: 431-435.
- [52] Luquet F, Milette M, Lacroix M. Use of lactic acid bacterium strain of whey obtained from fermentation using lactic acid bacterium strain for inhibiting growth of microorganisms. Patent. WO2008077229-A1; WO2008077229-A8. 2008.
- [53] GU S, IWASA T, BAMEN K. A medicinal composition composed of an extract of propolis, and royal jelly and/or dead cells of *Enterococcus faecalis* for cancer treatment with reduced adverse reactions. Patent. JP. 2002-586815. 2001.
- [54] Delgenes JP, Escare MC, Laplace JM, Moletta R, Navarro JM. Biological production of industrial chemicals, i.e. xylitol and ethanol, from lignocelluloses by controlled mixed-culture systems. *Industrial Crop and Products* 1998; 7: 101-111.
- [55] Murado MA, Pastrana L, Vazquez JA, Miron J, Gonzalez MP. Alcoholic chestnut fermentation in mixed-culture. Compatibility criteria *Aspergillus oryzae* and *Saccharomyces cerevisiae* strains. *Bioresource Technology* 2008; 99: 7255-4263.
- [56] Gonzalez C, Delgado O, Baigori M, Abate C, de Figueroa LIC, Callieri DA. Ethanol production from native cassava starch by a mixed-culture of *Endomycopsis fibuligera* and *Zymomonas mobilis*. *Acta Biotechnologica Polonica* 1998; 18(2): 149-155.
- [57] Kim DH, Hong YA. Co-fermentation of grape must by *Issatchenkia orientalis* and *Saccharomyces cerevisiae* reduces the malic acid content in wine. *Biotechnology Letters* 2008; 30: 1633-1638.

- [58] Abate C, Callieri D, Rodrogez E, Garro O. Ethanol production by a mixed-culture of flocculent strains of *Zymomonas mobilis* and *Saccharomyces* sp. *Applied Microbial Biotechnology* 1996; 45: 580-583.
- [59] Kargi F, Ozmihci S. Utilization of cheese whey powder for ethanol fermentations: effects of operating conditions. *Enzyme and Microbial Technology* 2006; 38; 711-718.
- [60] Lewandowska M, Kujawski W. Ethanol production from lactose in a fermentation/pervaporation system. *Journal of Food Engineering* 2007; 79: 430-437.
- [61] Szczodrak J, Szweczuk D, Fiedurek J, Rogalski J. Selection of yeast strain and fermentation conditions for high yield ethanol production from lactose and concentrated whey. *Acta Biotechnologica Polonica*; 17(1): 51-61.
- [62] Ghaly AE, El-Taweel AA. Effect of nutrient supplements addition of ethanol production from cheese whey using *Candida Pseudotropicalis* under batch condition. *Applied Biochemistry and Biotechnology* 1995; 53(2): 107-131.
- [63] Ghaly AE, El-Taweel AA. Kinetic modeling of continuous production of ethanol from cheese whey. *Biomass and Energy* 1997; 12(6): 461-472.
- [64] Ozmihci S, Kargi F. Ethanol fermentation of cheese whey powder solution by repeated fed-batch operation. *Enzyme and Microbial Technology*. 2007; 41: 169-174.

Chapter 7

In-situ product recovery of ethanol
by an organic-aqueous two-phase
extraction system

1. Abstract

A novel *in-situ* product recovery (ISPR) method, based on capsular perstraction is presented for ethanol extraction in batch fermentation systems, which utilizes microcapsules. In order to continuously remove ethanol, seventeen organic solvents were screened and a liquid-liquid extraction system using oleyl alcohol was compared to a new liquid-core encapsulation design with laurinaldehyde and 2-ethyl-1-butanol. Culture medium was brought into contact with capsules of 2 mm diameter that contained a hydrophobic core of solvent and an alginate-based membrane. This novel application permitted to characterize ethanol recovery with organic solvents, whose toxicity for the growing culture, prevents the use in ISPR applications.

The microcapsules were produced by coacervation and extrusion techniques which enable a maximum solvent loading capacity of 20% (w/v). Capsules were shown to be mechanically stable at 80°C and ethanol extraction performance was characterized with and without complexation of the alginate gel with oligochitosan. Mass transfer experiments assessed that ethanol diffusion through the capsule wall was not limiting the rate of extraction. A substantial reduction of the toxicity of the solvent was observed by encapsulating laurinaldehyde, but no improvement could be demonstrated with 2-ethyl-1-butanol. The ethanol extraction rate with encapsulated laurinaldehyde was $3.17 \text{ g}_{\text{EtOH}}/(\text{g}_{\text{solvent}}\cdot\text{s})$ while a specific ethanol production rate of $0.21 \text{ g}_{\text{EtOH}}/(\text{g}_{\text{biomass}}\cdot\text{h})$ was achieved with a consortium (CEKI) of *Kluyveromyces marxianus* (S1), *Issatchenkia orientalis* (S2) and *Enterococcus faecalis* (S3).

This chapter was submitted for publication in *Biotechnology Progress*
de Glutz FN, Hugonnet M, Holliger C, Marison IW. Mixed-culture fermentation of non-sterile whey permeate

2. Introduction

In-situ product recovery (ISPR), sometimes named “extractive fermentation”, involves methods taken for the immediate separation of a product from the producing cells. This offers an alternative to standard batch or fed-batch processing which are characterized by-product accumulation to potentially toxic levels, since product is removed as it is formed. The potential benefits inherent in this approach have attracted much attention in recent years [1-7]. ISPR is designed to increase the yield and productivity of a biotechnological process via three effects: (i) minimization of product losses which can either result from cross-interactions with the producing cells, environmental conditions or uncontrolled removal from the system (such as by evaporation); (ii) reduction in the number of subsequent downstream processing steps (to avoid chromatographic purification by-product extraction); (iii) minimization of inhibition resulting from product accumulation with the producing cells allowing for continuous expression at the maximum production level (such as ethanol with yeast cells). Interference by the accumulating product with the producing cells often occurs on the biochemical level, namely product inhibition or further product metabolism/biotransformation [2, 8]. Product accumulation may also affect aspects of cell physiology, such as growth rate [3, 9].

A product may be removed from the vicinity of the producing cells by various possible techniques:

- Evaporation, via vacuum fermentation, gas stripping or pervaporation, which are mainly effective for low molecular weight volatile products, such as ethanol or butanol [3, 10-11], when applying a vacuum to the fermentation headspace or by stripping with an inert gas;
- Extraction into another phase using water-immiscible organic solvents, supercritical fluids or a second aqueous phase [2-3, 9, 12-13]. Two modes of operation have been used for product removal: direct addition of the water-immiscible organic solvent into the reactor or circulation of the medium through an external extracting unit, thus reducing direct contact between the extracting solvent and the producing cells;
- Size selectivity permeation based on membrane dialysis [2-4, 14];
- Reversible complex formation based on chemical reaction with soluble or insoluble reagents (e.g. Schiff's base formation) or biological recognition resulting in precipitation of insoluble complexes [15];
- Product immobilization via adsorption or specific binding onto water-insoluble polymeric carriers [16].

ISPR techniques may involve a combination of two or more of the above techniques, such as when membrane permeation is combined with an extraction step or with immobilization of producing cells [17-19].

The small size of the ethanol molecule and its physical properties mean that evaporation and extraction techniques have been extensively used for ethanol recovery. Extraction into a second liquid phase has also been widely studied. However many solvents with a high extraction capacity exhibit toxicity to the producing cells [3, 12]. Physical separation by either a membrane or a polymer barrier can in many cases prevent this toxicity and allow operating of this type of system [20]. In this study various organic solvents were investigated for *in-situ* ethanol recovery from whey permeate broth. Direct contact assays were compared to encapsulated solvent systems for preventing phase toxicity for cultivated cells.

Designing and choosing a suitable encapsulation method, is based on simplicity of the technique and the number of steps during the immobilisation must be limited in order to limit possible problems. Materials should be cheap and reusable, the geometry and the size adapted to the goals. In this study a spherical shape was chosen since this can be achieved by extrusion-based techniques and because it is possible to use either in suspension, fluidized bed or fixed bed modes. Finally the diameter should be of the range of 1 mm in order to reduce mass transfer limitations [20].

2.1 Solvent toxicity

The toxicity of solvents can be divided into two major classes, molecular and phase toxicity [21-24].

Phase toxicity: The term phase toxicity is used when direct contact of cells with the solvent causes a toxic effect. The mechanism which describes this class of toxicity is the disruption of the cell wall or membrane resulting from an adherence of the cells to the interface or entrapment in an emulsion [20, 25-26].

Molecular toxicity: While phase toxicity describes the effect due to direct contact of a solvent with cells, molecular toxicity describes the consequence of the solvent solubility on cell viability. The lipid membranes of cells are directly affected by the quantity of solvent dissolved in the medium resulting in a modification of the membrane permeability. As a result, cells become incapable of actively transporting nutrients and finally die [27-28]. Molecular toxicity was shown to be linked to hydrophobicity, since the more hydrophobic the solvent, the less solvent dissolves in the aqueous phase [29-30], and therefore the lower the toxicity towards cells.

2.2 Encapsulation for decreasing solvent toxicity

Since phase toxicity is a result of direct contact with cells, various techniques have been used to prevent this. The use of membranes allows, either by size exclusion or hydrophobicity, separation of the culture solution and the solvent [21]. Cells can be retained by a filter and the solvent is put in contact with the aqueous phase in a system separated from the culture vessel [31]. Another possibility consists in encapsulating the solvent and/or the cells which are then physically separated [20] in a process termed capsular perstraction. Gel polymers, such as alginate or cellulose, may be used to form the capsule membrane. However it is more difficult to totally prevent molecular toxicity. As solvents are small molecules, they readily diffuse through the membrane pores and into the medium. The encapsulation technique represents an interesting strategy for separating both medium and solvent by a hydrogel layer [32], while preventing direct contact of solvent with cells, as well as simplifying phase separation and the avoidance of stable emulsion formation.

2.3 Choice of polymer

The choice of polymer to create the capsules requires consideration of the specific characteristics of the encapsulation solutions: easy mixing of the material with the polymer solution, quick gelation of the mixture, no chemical reaction between gelation agents and products, good mechanical resistance of the gel and stable matrix to temperature and pH [33].

2.3.1 *Synthetic polymers*

Many gel compositions exist with very different properties which can be readily varied by changing the nature of the monomer and the linear copolymer, such as polymers of styrene and divinyl benzene [34-36]. They have the advantage of having a high porosity however, suffer from the major drawback of being toxic for living organisms which cause significant losses of viability and, what is more, they are expensive. These types of polymers are mainly used in synthetic chemistry where the process requires a high mechanical and chemical stability.

2.3.2 *Polysaccharides*

These types of polymers are usually cheap and few are toxic for cells. Three major types of polysaccharides are used for encapsulation: κ -carrageenan / agarose, cellulose, and alginate. These structures may be subsequently coated with a chitosan membrane, which improves mechanical characteristics of the polymer.

κ -carrageenan / agarose

This category of polymers has the advantage that the biocatalyst has a long shelf life resulting in stable biochemical activity. Mechanical performance is improved significantly by the cross-linking of the matrix through addition of glutaraldehyde or hexamethylenediamine [35]. However these properties dramatically drop when the polymer is exposed to temperatures higher than 37°C [33] which makes κ -carrageenan / agarose polymers non-suitable for ethanol extraction, since back extraction of the ethanol from the capsules requires high temperatures (≥ 72 -75°C).

Cellulose

Cellulose polymers, such as carboxymethyl cellulose, are very cheap and permit a rapid transport of ethanol through the membrane because of their high porosity [37]. The major drawback might be excessive exodiffusion of the solvent.

Alginate

Widely used in microbiology, alginate is cheap and presents similar characteristics to κ -carrageenan. These polyelectrolytes form hydrogels in the presence of divalent cations, are relatively resistant to abrasion and withstand thermal treatment. The mechanical stability can be improved further by diverse treatments, which do not affect cellular viability [33, 38-39]. The principal inconvenience of utilizing alginate gels is the vulnerability to chelating agents, such as phosphate anions, although the addition of Ca^{2+} or other divalent cations, can reinforce interactions between the polymer chains. Another drawback can be its high viscosity, which can make extrusion to form microcapsules difficult.

As a result, calcium alginate seems to be the most suitable polymer for the formation of microcapsules for use in ethanol extraction because it is cheap, presents good mechanical properties, is non-toxic for microorganisms, and provides good resistance to the thermal treatments necessary for the recovery of ethanol. Since an effective removal of ethanol from fermentation media requires a large interfacial mass transfer area, the number and size of the microcapsules must be optimized.

2.4 Properties of alginate*2.4.1 Characteristics*

The name alginate comes from specific algae, such as *Macrocystis pyrisea*, which produce alginic acid. Alginates are a family of linear unbranched copolymers, formed from β -D-mannuronic acid (M) and α -L-guluronic acid (G) (Figure 1A). These acids are linked by a β -1-4 bond and of a range of monomer sequences. Monomers are positioned along the polymer chain to form M, G and MG blocks as shown in Figure 1B, when complexed with divalent cations, such as Ca^{2+} .

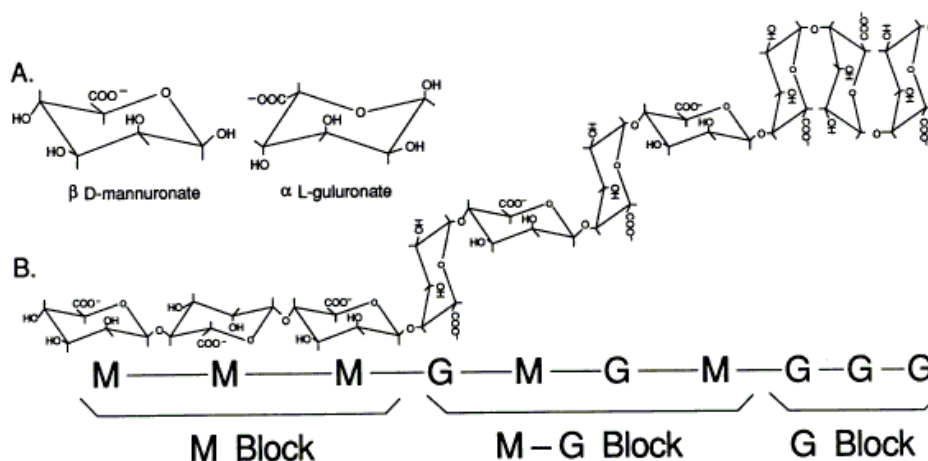

Figure 1. Polymeric structure of alginate (A) single monomers from alginate polymer chains (B). Structural differences in polymerized alginate gel are due to relative amounts, and sequence of β -D-mannuronic acid (M) and α -L-guluronic acid (G) (*archimede.bibl.ulaval.ca*).

2.4.2 Mechanical properties

The properties of alginates vary strongly according to the composition of the monomer, the molecular weight of the monomer and the length of the G blocks [39]. The rigidity of the alginate structure increases with the proportion of GG blocs [40]. This fact can be explained by the preference of Ca^{2+} ions to bind to G blocs during the gelation step. It is also important to choose alginate of a certain molecular weight, because gelation efficiency is reduced if the alginate chains are too short. The viscosity depends of the size of the polymer and increases with increasing molecular weight [38-39]. Finally it is also important to evaluate a suitable concentration of alginate in order to ensure good mechanical properties without negatively influencing mass transfer, but also to ensure maximal solvent loading capacity in the capsules. Co-complexation with chitosan (Figure 2) results in improved mechanical properties compared with alginate gels. The oligomeric chains of chitosan are able to penetrate the alginate gel and resulting in an increase in overall rigidity and mechanical strength.

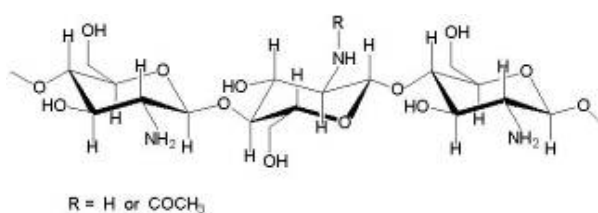

Figure 2. Chitosan unit [32].

2.4.3 *Molecular diffusion*

In some cases diffusion is a real problem when using alginate matrixes, particularly when macromolecular proteins are secreted, however this is rarely a problem for small, relatively chemically neutral molecules such as ethanol [38]. Previous studies showed that a gel composed of 2% of alginate yields pores between 5 and 200 nm in diameter [41], which is large enough to ensure good penetration of ethanol molecules. The encapsulation of organic solvents aims to decrease the toxic effect of the solvent on microorganisms and it is thus the “leaking” of the solvent (exodiffusion) through the capsule membrane which needs to be avoided. This is achieved by the use of hydrogels, such as those formed by alginates.

2.4.4 *Chemical stability*

The main limitation in using calcium alginate capsules is their sensitivity to chelating agents such as phosphate, citrate or lactate. These compounds compete for Ca^{2+} ions, causing the calcium alginate chains to separate and become soluble. It is possible to reduce this effect in cell cultures by the addition of Ca^{2+} (0.01-0.02 M) to the medium [39, 40-42].

3. **Materials and Methods**

3.1 **Microorganisms, inocula preparation and media**

A consortium (CEKI) of *Kluyveromyces marxianus* (S1), *Issatchenkia orientalis* (S2) and *Enterococcus faecalis* (S3), described in chapter 6 was used for assessing *in-situ* product recovery when fermenting whey permeate. Stock cultures were stored as a suspension in 9 g/L NaCl and 10 g/L glycerol at -80°C. Cells were re-activated in a 1-liter baffled shake-flask containing 100 mL YPL medium at 30°C for 24h. Two cultures in baffled shake-flasks of 100 mL each were used to prepare the inocula. After 24 h at 30°C, the two precultures were centrifuged at 4°C (10 minutes at 1500 g) and the cell pellets resuspended in 10 mL sterile water and used immediately. YPL medium contained 40 g/L lactose, 6 g/L yeast extract (Oxoid, Hampshire, England) and 5 g/L Bacto™Peptone (Becton, Le Pont de Claix, France) and sterilized by filtration (0.22 µm, Steriltop, Millipore Corporation, Billerica, USA).

The culture medium used was whey permeate powder (Crema, Villars-sur-Glâne, Switzerland) reconstituted to 40 g/L or 100 g/L, completed with 3.75 g/L of yeast extract

(Oxoid, Hampshire, England), and pasteurized at 65°C for 30 min, then quickly cooled to operating temperature just prior to inoculation.

3.2 Reagents, biomass and metabolite analysis

Lactose, lactic acid and ethanol concentrations were determined by HPLC analysis (1100 series, Agilent Technologies, Palo Alto, USA). An ion exchange chromatography column (Supelcogel H, 30 cm x 4.6 mm; 9µm, Supelco, Bellefonte, USA) was used at 60°C. A 0.005 M H₂SO₄ solution in ultrapure water was applied at a constant eluent flow rate of 0.6 mL/min. Metabolites were measured using an IR-refractive index detector. Cell density was determined using the packed cell volume (PCV) technique (VoluPAC, Sartorius, Germany). Tubes were filled with 200-500 µL of culture sample and stirred (4000 g) for 2 minutes before measuring biomass on a graduated scale.

3.3 Measurement of the ethanol partition coefficient

The partition coefficient is a measure of the capacity of the solvent for the product and is defined as the ratio $c_{\text{EtOH,orga}} / c_{\text{EtOH,aq}}$. Five mL of an organic solvent were vigorously mixed for 10 min with 5 mL of (i) distilled water, (ii) 100 g lactose/L whey permeate medium, having an initial ethanol concentration of 3, 5, 10 and 20% (v/v). The two phases were separated by centrifugation, followed by measurement of ethanol in the aqueous phase.

Solvents tested were 2-ethyl-1-butanol (Fluka, Lot :1245726), 2-ethyl-1,3-hexanediol (Aldrich, Lot : E29125), oleyl alcohol (*cis*-9-octadecen-1-ol, Fluka, Lot : 362896), dibutyl phthalate (Fluka, Lot : 360852), n-hexadecane (Acros organics, Lot : A015845501), sebacic acid (dibutyl decanedioate, Sigma, Lot : 102H0529), soybean oil (Sigma, 39F-0493), castor oil (Fluka, Lot : 358315), silicone oil (Fluka, Lot : 32264111), polypropylene glycol (PPG) 2000 (Fluka, 273160-687), PPG 1200 (Fluka, 349336), kerosene (Acros organics, Lot : A0247220), oleic acid (*cis*-9-octadecenoic acid, Fluka, Lot : 397407), tributyl phosphate (Fluka, Lot :1251120), dibutyl adipate (dibutyl hexanedioate, Aldrich, Lot :66788-026), 3-methyl-1-butanol (Sigma-Aldrich : Lot :533034-337), 3-pentanol (Aldrich, Lot : P8025) and lauraldehyde (methyl dodecanoate, Fluka, Lot : 1317034).

3.4 Biocompatibility measurements

In order to determine whether the extractive solvent was toxic for the mixed-culture (§2.1), CEKI was grown in batch mode at 30°C, in direct contact with the extractive solvent. Growth of the cells in the two-phase system (culture medium / solvent) was compared with a reference culture grown on whey permeate solution in the absence of solvent. Molecular toxicity was tested by fermenting 40 g/L whey permeate solution in 100 mL shake-flasks filled with 75 mL of whey permeate solution and 25 mL of solvent stirred at 100 rpm and setting the initial biomass concentration to 5 g/L. Phase toxicity was determined by increasing the agitation rate to 300 rpm when fermenting an identical culture medium as in molecular toxicity experiments, resulting in an emulsion between the medium and the solvent. Solvents used for biocompatibility tests were 2-ethyl-1-butanol, oleyl alcohol, tributyl phosphate, 3-methyl-1-butanol, 3-pentanol and laurinaldehyde.

3.5 Capsule production

Mononuclear capsules were produced by the direct extrusion method. The capsules contained (i) laurinaldehyde or (ii) 2-ethyl-1-butanol as core material and had an alginate based polymeric membrane. Sodium alginate solution (6% w/v) was mixed with the desired encapsulation solvent in the ratio 4:1 v/v to obtain a homogeneous emulsion which was extruded through a 1.2 mm diameter needle at a flow rate of 100 mL/h. Alginate solution was prepared in an isotonic buffer containing 10 mM 3-(N-morpholino)propanesulfonic acid (MOPS), 0.85 % w/v NaCl, pH 7 and filtered sterilized. The capsules were collected in a gelling bath containing 10 mM MOPS at pH 7 and 200 mM CaCl₂ [32]. For the production of coated capsules, the saline solution was subsequently separated and the beads added to an agitated solution containing 1% w/v low molecular weight chitosan (Acros Organics, A2044263) and 100 mM HCl for 10 min at room temperature and stored in isotonic buffer solution.

3.6 Batch cultures

Assessment of *in-situ* ethanol recovery was carried out with oleyl alcohol, laurinaldehyde and 2-ethyl-1-butanol. The non-toxicity of oleyl alcohol for the microbial population enabled

direct liquid-liquid extraction while the encapsulated solvent method was required for lauraldehyde and 2-ethyl-1-butanol. Shake-flask cultures were performed in 250 mL Erlenmeyer flasks stirred with a magnetic stirrer at 360 rpm, 30°C and contained 75 mL of whey permeate solution and 50 mL of encapsulated solvent beads. In direct contact experiments, 25 mL of oleyl alcohol was added in place of the capsules. Initial biomass concentration was set to 3 g/L.

4. Results and Discussion

An organic-aqueous, two-phase extraction system, was studied for the continuous removal of ethanol from fermentation medium. An evaluation of a successful procedure for ISPR process is described involving:

- an extensive solvent screening to assess applicability in an extractive fermentation. Promising solvents were experimentally tested for determining ethanol extraction performance and to define biocompatibility through direct contact with cells.
- based on the bioconversion characteristics and the behavior of the mixed-culture in the presence of the solvent, an encapsulation technique was developed. Ethanol mass transfer was characterized with the encapsulated solvent system.
- an *in-situ* ethanol extractive system was characterized using batch cultures using solvents encapsulated in alginate-based hydrogels.

4.1 Selection of a solvent

In a first step, theoretical and experimental procedures were used for the systematic screening of potential extractive solvents. Selection criteria were: high ethanol extraction performance (system efficiency), high boiling point (easy recovery of ethanol), density difference with water (easy phase separation), price (low cost) and high biocompatibility (reported non-toxicity). Over 200 solvents were screened according to these criteria from the literature [43-48] but very few have been reported to combine high ethanol extraction performance and non-toxicity for microorganisms. As a result, a range of non-tested solvents were also selected for ethanol recovery since they had demonstrated good performance with similar low molecular weight alcohols [43-48]. The 17 pre-screened solvents, listed in Table 1, were first tested for ethanol extraction efficiency in water and whey permeate. Ethanol partition coefficients (P_E) with an initial ethanol concentration of 20% (v/v) in pure water ($P_{E/W}$) and whey permeate

($P_{E/M}$) are reported in Table 1 and show the influence of the medium. With the exception of silicone oil, the measured partition coefficients are 50 to 100% higher in whey permeate solution than in pure water showing that the gradient is more favorable for ethanol extraction when the ionic strength of the medium is high. From the results obtained for other ethanol concentrations, ionic strength clearly acts on coefficient partition. It was observed that P_E decreased when extracting ethanol from 10, 5 and 3% (v/v) EtOH solutions. Among these solvents, five were characterized by a partition coefficient greater than 1, meaning that, at equilibrium, the concentration of ethanol in the organic phase was higher than in the aqueous phase.

Table 1. List of successfully pre-screened solvents that were submitted to experimental determination of the P_E partition coefficient in water ($P_{E/W}$) and in whey permeate medium ($P_{E/M}$).

Solvent	b.p. °C	density $\text{g}\cdot\text{cm}^{-3}$	price $\text{CHF}\cdot\text{L}^{-1}$	logP -	metabolic activity %	$P_{E/W}$ $c_{\text{orga}}\cdot c_{\text{aq}}^{-1}$	$P_{E/M}$ $c_{\text{orga}}\cdot c_{\text{aq}}^{-1}$
3-pentanol	116	0.82	n.a.	1.14	0	1.02	1.65
3-methyl-1-butanol	131	0.81	45	1.14	0	1.06	1.62
2-ethyl-1,3-hexanediol	244	0.93	49	1.2	0	0.81	1.33
2-ethyl-1-butanol	146	0.83	100	n.a.	100 ^a	0.83	1.27
Tributyl phosphate	289	0.97	n.a. ^b	n.a.	0	0.61	1.10
Laurinaldehyde	239	0.84	n.a.	n.a.	0-80	0.42	0.81
PPG 1200	>230	1.04	43	n.a.	0	0.47	0.80
PPG 2000	>230	1.04	43	n.a.	100	0.31	0.54
Oleyl alcohol	330	0.85	33	7.5	100	0.24	0.45
Castor oil	229	0.96	18	n.a.	100	0.08	0.31
Dibutyl adipate	305	0.96	56	n.a.	100	0.17	0.28
Dibutyl phthalate	340	1.05	15	4.3	n.m. ^c	0.15	0.23
Sebacic acid	294	1.21	79	n.a.	n.m.	0.10	0.14
Soybean oil	n.a.	n.a.	70	7.4	n.m.	0.09	0.11
n-hexadecane	287	0.773	20	8.7	n.m.	0.06	0.066
Silicone oil	>300	0.96	32	n.a.	n.m.	0.06	0.048
Kerosene	200	n.a.	n.a.	n.a.	n.m.	0.04	0.044

^a highly reduces the growth rate but not the ethanol production

^b data not available

^c data not measured

These solvents were 3-pentanol, 3-methyl-1-butanol, 2-ethyl-1,3-hexanediol, 2-ethyl-1-butanol and tributyl phosphate. However, 3-pentanol, 3-methyl-1-butanol and tributyl phosphate formed stable emulsions with the aqueous phase making phase separation difficult. To these five solvents it was decided to also test oleyl alcohol, since this solvent is frequently used as a reference solvent for ethanol extraction [44-45, 48], PPG 1200 and laurinaldehyde for biocompatibility essays.

Growth in shake-flask batch cultures with CEKI was used to assess toxicity of the organic phase. A reference culture was carried out in parallel, to which no solvent was added. Of the solvents tested:

- 3-pentanol, 3-methyl-1-butanol, 2-ethyl-1,3-hexanediol, tributyl phosphate, and PPG 1200 exhibited both molecular and phase toxicity characterized by a strong inhibition of growth and ethanol production, consequently no further studies were carried out with these solvents.
- 2-ethyl-1-butanol inhibited growth (Figure 3) of the mixed-culture as well, however, measurements of ethanol production during the cultures revealed that ethanol was produced during all the experiment suggesting that 2-ethyl-1-butanol did not affect metabolic activity and ethanol production of the consortium culture (data not shown).
- In the case of laurinaldehyde (Figure 4), batch cultures performed with vigorous agitation, for assessing phase toxicity, were strongly inhibited, while no significant effect was observed at low agitation rates. Thus it was concluded that laurinaldehyde exhibits no molecular toxicity but does show phase toxicity.
- No difference in growth or ethanol production was observed when oleyl alcohol was used as extractant (Figure 5), indicating that this solvent is completely biocompatible.

From these results three solvents: oleyl alcohol, laurinaldehyde and 2-ethyl-1-butanol were retained for further characterization for continuous *in-situ* ethanol recovery. While non-toxicity of oleyl alcohol allows product removal by direct liquid-liquid extraction, laurinaldehyde presents phase toxicity, while both laurinaldehyde and 2-ethyl-1-butanol show molecular and phase inhibition of growth. In order to use these solvents for ISPR it is thus necessary to overcome the inhibition. Encapsulation of the solvents in calcium-alginate was chosen as a system to avoid direct contact of the organic phase with the mixed-culture, and thus avoiding solvent toxicity.

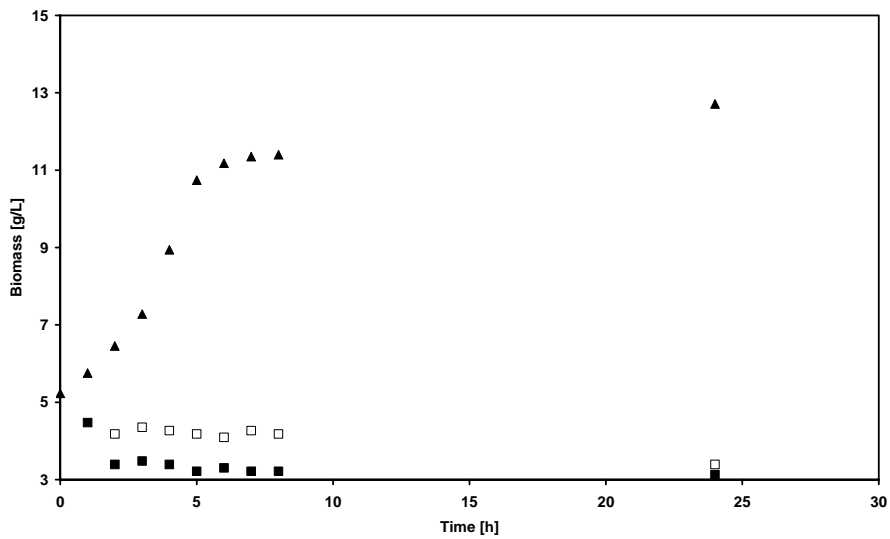

Figure 3. Growth of mixed-culture CEKI, composed of *K. marxianus* (S1), *I. orientalis* (S2) and *E. faecalis* (S3). Cultures were performed in 100 mL shake-flasks with an initial solvent volume of 1:3 of the whey permeate medium (▲) in the absence of solvent, (■) in the presence of 2-ethyl-1-butanol stirred at 100 rpm and (□) in the presence of 2-ethyl-1-butanol stirred at 300 rpm to obtain an emulsion. Cultures were undertaken in batch mode at 30°C.

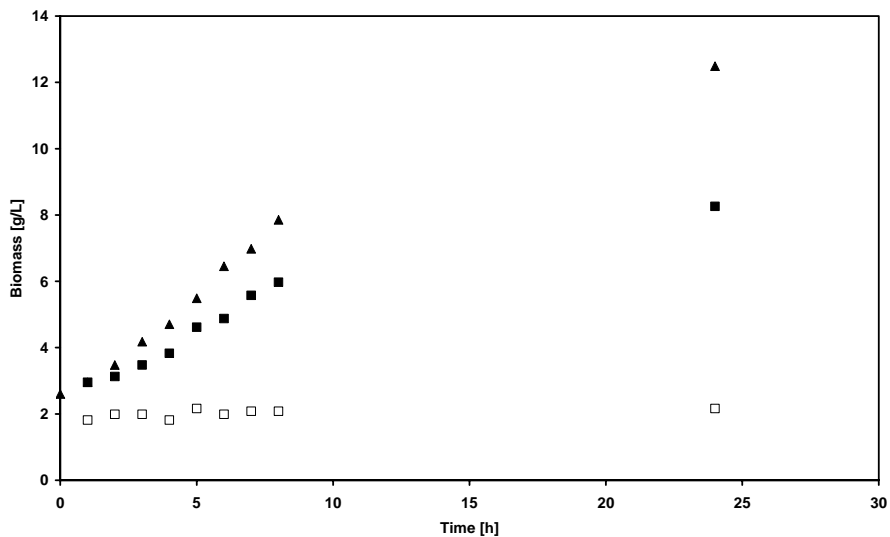

Figure 4. Growth of mixed-culture CEKI, composed of *K. marxianus* (S1), *I. orientalis* (S2) and *E. faecalis* (S3). Cultures were performed in 100 mL shake-flasks with an initial solvent volume of 1:3 of the whey permeate medium (▲) in the absence of solvent, (■) in the presence of laurinaldehyde stirred at 100 rpm and (□) in the presence of laurinaldehyde stirred at 300 rpm to obtain an emulsion. Cultures were undertaken in batch mode at 30°C.

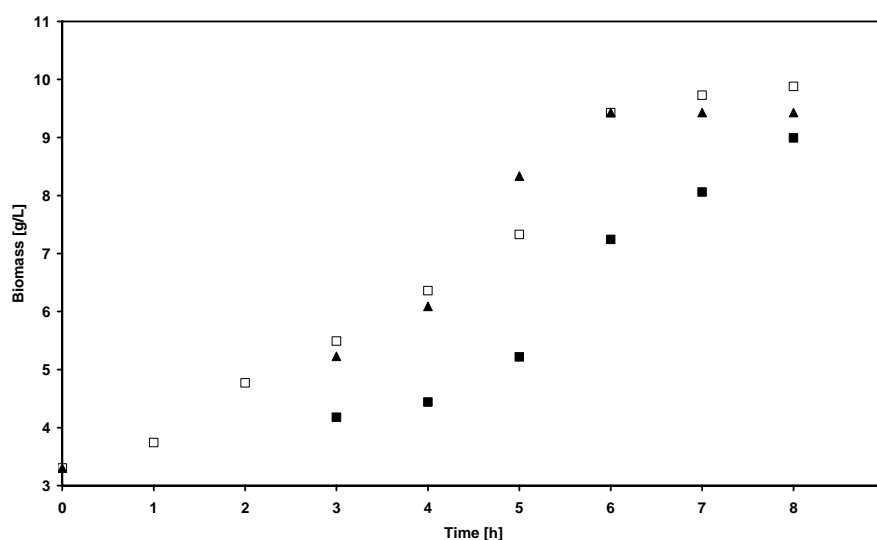

Figure 5. Growth of mixed-culture CEKI, composed of *K. marxianus* (S1), *I. orientalis* (S2) and *E. faecalis* (S3). Cultures were performed in 100 mL shake-flasks with an initial solvent volume of 1:3 of the whey permeate medium (▲) in the absence of solvent, (■) in the presence of oleyl alcohol stirred at 100 rpm and (□) in the presence of oleyl alcohol stirred at 300 rpm to obtain an emulsion. Cultures were undertaken in batch mode at 30°C.

4.2 Capsule characterization

Coacervation was applied to create liquid-core capsules containing lauraldehyde and 2-ethyl-1-butanol. This method is commonly used when the organic phase is hydrophobic and results in small droplets when vigorously agitated with capsules obtained by the addition of Ca^{2+} to the suspension. A subsequent wall stabilization step is possible through a chemical cross-linking step using chitosan (§2.4.2).

Capsules were produced according to the method described in §3.5 and the permeability with respect to ethanol was determined, as well as mass transfer limitations, size distribution and mechanical / heat resistance properties. Ethanol diffusion in pure water is very rapid ($1.1 \cdot 10^{-5} \text{ cm}^2/\text{s}$) [32] and decreases with increasing alginate concentration. Thus this value decreases to $1.0 \cdot 10^{-5} \text{ cm}^2/\text{s}$ in 2% (w/v) alginate solution [41], $0.8 \cdot 10^{-5} \text{ cm}^2/\text{s}$ in 4% (w/v) alginate solution [42], and $0.5 \cdot 10^{-5} \text{ cm}^2/\text{s}$ in 6% (w/v) alginate solution [20]. Breguet (2007) reported that an alginate concentration of 6% (w/v) was the optimal compromise for loading a maximal solvent quantity in the capsules without negatively influencing mass transfer. The characteristics of liquid-core calcium alginate capsules were compared with those coated with

chitosan. Spherical microcapsules of 2 ± 0.5 mm diameter were produced by the coacervation method and permitted to entrap 20% (v/v) of solvent. The opaque aspect of the capsules resulted from the entrapment of the solvent emulsion with the alginate solution during gelation (Figure 6).

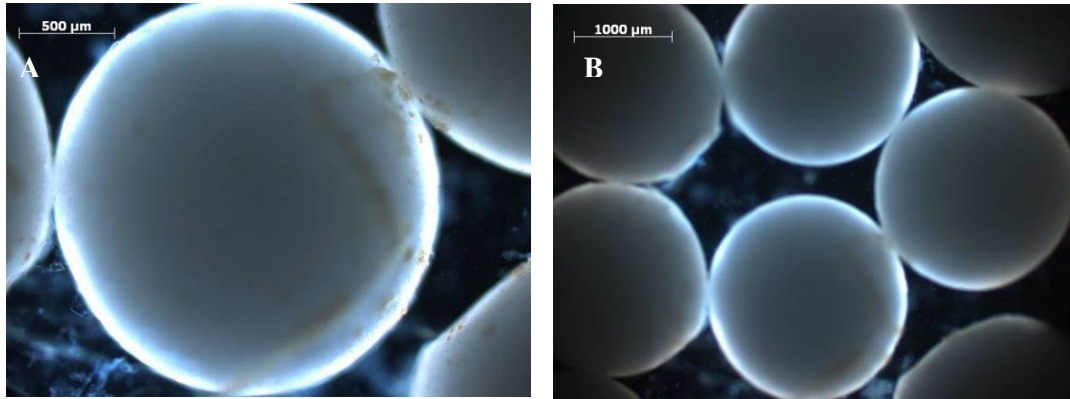

Figure 6. (A) 5x enlargement and (B) 2.5x enlargement pictures of capsules formed from 80% polymer solution with 6% (w/v) alginate and 20% laurinaldehyde.

Back extraction/recovery of ethanol is achieved by heating the capsules at the boiling point of ethanol (78.4°C). It is essential, in order that the capsules can be re-used, that during this phase the capsules are not damaged. Thermal stability was confirmed by heating the capsules for 30 min at 80°C however, at 121°C disruption of the majority of capsules was observed resulting in solvent leakage. Consequently it was demonstrated that, capsules were stable at 80°C, resulting in possible ethanol recovery and capsule recycling. The instability at 121°C implies that the capsules should be produced under sterile conditions from pre-sterilized solutions, rather than autoclaved prior to use in bioprocesses.

Table 2 compares the ethanol diffusion coefficient (k_E) obtained with pure alginate beads and capsules composed of alginate membranes surrounding a core of laurinaldehyde or 2-ethyl-1-butanol. The effect of heat treatment and coating with chitosan is also described. Diffusion coefficient k_E is defined by equation 1:

$$D = \frac{k_E \cdot S \cdot \Delta c}{L} \quad (1)$$

where: D the diffusion rate [$\text{g}\cdot\text{s}^{-1}$]

k_E the diffusion coefficient [$\text{cm}^2\cdot\text{s}^{-1}$]

S is the exchange surface [cm^2]

Δc the difference in concentration between the core and surrounding medium [$\text{g}\cdot\text{cm}^{-3}$]

L the thickness of the membrane layer [cm]

Table 2. Ethanol diffusion coefficients k_E measured in alginate beads, encapsulated laurinaldehyde and 2-ethyl-1-butanol prior and after thermal treatment by heating at 80°C for 30 minutes.

Bead and capsule materials	Ethanol diffusion coefficient ¹			
	$k_E \cdot (10^{-5} \text{ cm}^2 \cdot \text{s}^{-1})$			
	prior thermal treatment		after thermal treatment	
	uncoated	coated ²	uncoated	coated ²
Alginate Beads	0.47	-	0.71	-
Alginate/2-ethyl-1-butanol	1.28	0.96	1.75	1.59
Alginate/Laurinaldehyde	0.27	0.66	0.33	0.56

¹ determined for for a drop of Δc from 2.5 g/L to 0.4 g/L

² refers to capsules with have been treated with chitosan

The ethanol diffusion coefficient measured in 6% (w/v) alginate beads was $0.47 \cdot 10^{-5} \text{ cm}^2/\text{s}$, which is similar to the value of $0.50 \cdot 10^{-5} \text{ cm}^2/\text{s}$ obtained by Stark (2001). The diffusion coefficient obtained with capsules composed of alginate and 2-ethyl-1-butanol was $1.28 \cdot 10^{-5} \text{ cm}^2/\text{s}$. Thus it appears that ethanol penetrates into the capsules at a 3-fold higher rate than into solid alginate beads. Since alginate is essentially 94% water, this suggests that the distance over which the ethanol diffuses in beads and capsules is responsible for rate of mass transfer, with the solvent-core absorbing the ethanol rapidly. In the case of laurinaldehyde, the diffusion coefficient of $0.27 \cdot 10^{-5} \text{ cm}^2/\text{s}$ is probably the result of mass transfer limitations due to a stagnant layer of laurinaldehyde.

Heating the capsules to 80°C for 30 minutes led to a substantial increase of the diffusion coefficient for all systems tested, alginate beads, alginate capsules and coated alginate capsules. This may be due to the expulsion of water from the gel causing a reduction in the size of the beads and capsule membrane thickness [50]. This is confirmed by the larger increase of k_E for 2-ethyl-1-butanol capsules, where the alginate membrane was probably responsible for the mass transfer limitation compared to laurinaldehyde, where the solvent layer was limiting. Finally the values of k_E measured with capsules coated with chitosan demonstrated a 25% loss of wall permeability (from $1.28 \cdot 10^{-5} \text{ cm}^2/\text{s}$ to $0.96 \cdot 10^{-5} \text{ cm}^2/\text{s}$) in 2-ethyl-1-butanol capsules before heating, with a decrease of only 9% (from $1.75 \cdot 10^{-5} \text{ cm}^2/\text{s}$ to $1.59 \cdot 10^{-5} \text{ cm}^2/\text{s}$) after thermal treatment. This small reduction in k_E was caused by the chitosan reducing the amount of water lost during the thermal treatment, with the result that the capsule membrane did not change appreciably in size.

4.3 Batch cultures

The viability of the mixed microbial culture to the presence of 2-ethyl-1-butanol and laurinaldehyde was compared with encapsulation of the solvents in order to define whether phase toxicity could be controlled. Figures 7-9 show batch growth profiles for CEKI, grown in flask cultures with 40 g/L whey permeate. Comparison of direct contact of the ethanol-producing culture with the encapsulated laurinaldehyde system is shown in Figure 7. The toxicity of the solvent, demonstrated in § 4.1, was partially overcome by encapsulating the solvent in alginate capsules. By comparison with the reference culture, performed without any solvent, 20% less biomass was produced with the encapsulated laurinaldehyde extraction system, while 92% less biomass was produced when the solvent was placed in direct contact with the aqueous phase. A closer observation of the alginate encapsulated laurinaldehyde system suggests that two growth phases can be observed. The first, for the initial three hours, was probably due to laurinaldehyde diffusing through the alginate membrane and attaining the equilibrium solubility, which resulted in some molecular toxicity, causing an initial reduction for the first 6-7 hours of culture.

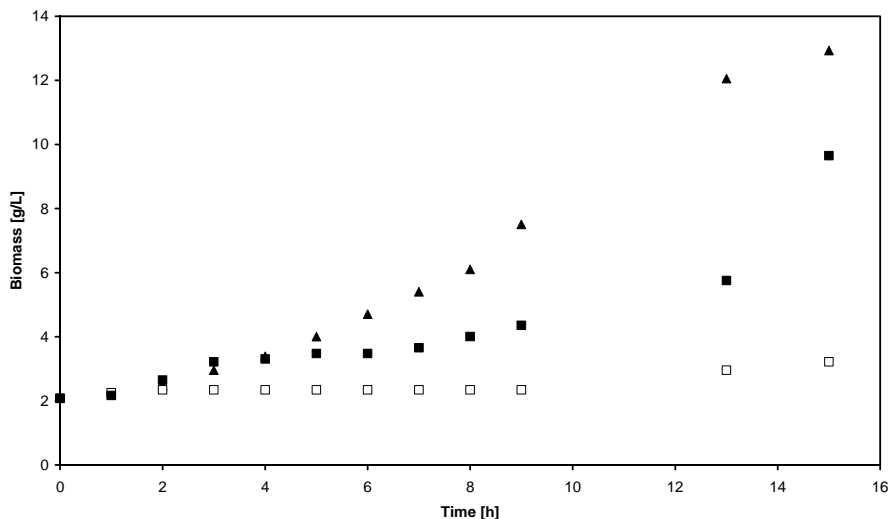

Figure 7. Growth of mixed-culture CEKI, composed of *K. marxianus* (S1), *I. orientalis* (S2) and *E. faecalis* (S3) on 40 g/L whey permeate. Cultures were performed in 250 mL shake-flasks with an initial capsule volume of 2:3 of the whey permeate medium (▲) in the absence of solvent, (■) with alginate-based microcapsules with a core of laurinaldehyde (□) and with direct contact of laurinaldehyde. Cultures were undertaken in batch mode at 30°C, stirred at 360 rpm.

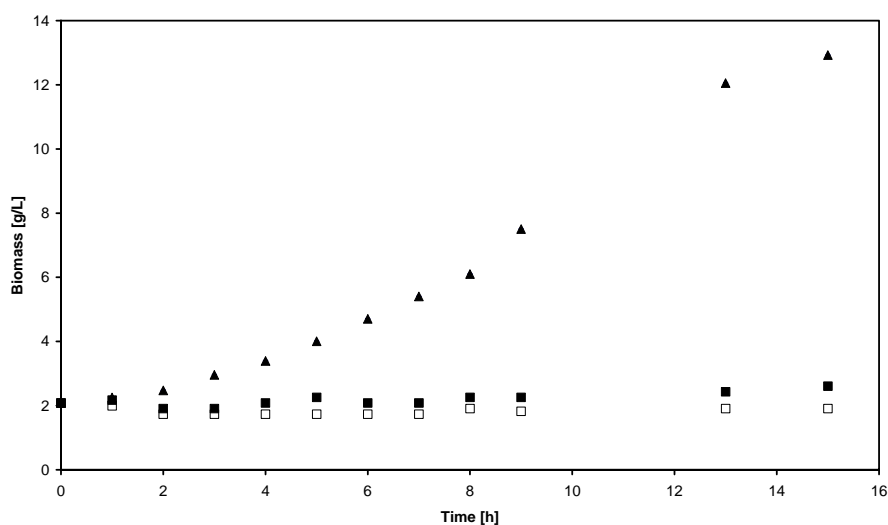

Figure 8. Growth of mixed-culture CEKI, composed of *K. marxianus* (S1), *I. orientalis* (S2) and *E. faecalis* (S3) on 40 g/L whey permeate. Cultures were performed in 250 mL shake-flasks with an initial capsule volume of 2:3 of the whey permeate medium (▲) in the absence of solvent, (■) with alginate-based microcapsules with a core of 2-ethyl-1-butanol (□) and with direct contact of 2-ethyl-1-butanol. Cultures were undertaken in batch mode at 30°C, stirred at 360 rpm.

Subsequently, the growth rate increased to that of the reference culture, thereby showing that encapsulation indeed protected the microbial culture from laurinaldehyde. Encapsulation of ethyl-1-butanol however did not present a real advantage for overcoming cells growth inhibition (Figure 8), since no growth was observed when placed in direct contact or encapsulated in alginate-based microcapsules.

The specific ethanol productivity of CEKI (Figure 9) in the reference culture was determined to be $0.21 \text{ g}_{\text{EtOH}}/(\text{g}_{\text{biomass}} \cdot \text{h})$. An efficient ISPR system must be able to recover ethanol from the fermentation medium at a similar rate as ethanol is produced, in order to avoid product accumulation. With the minimal k_E value of $0.27 \cdot 10^{-5} \text{ cm}^2/\text{s}$ for alginate-based capsules containing laurinaldehyde, the diffusion rate is $2.23 \cdot 10^{-6} \text{ g}_{\text{EtOH}}/(\text{s} \cdot \text{capsule})$. Considering the volume of one capsule equal to $4.19 \cdot 10^{-3} \text{ cm}^3$ (loaded with 20% w/v alginate), the quantity of encapsulated laurinaldehyde is $7.04 \cdot 10^{-4} \text{ g}_{\text{solvent}}/\text{capsule}$, meaning that $3.17 \cdot 10^{-3} \text{ g}_{\text{EtOH}}/(\text{g}_{\text{solvent}} \cdot \text{s})$ may be recovered. This value should be possible to improve by reducing the size of the capsules, thereby increasing the specific interfacial mass transfer area, as well as by increasing the number of capsules added to the culture.

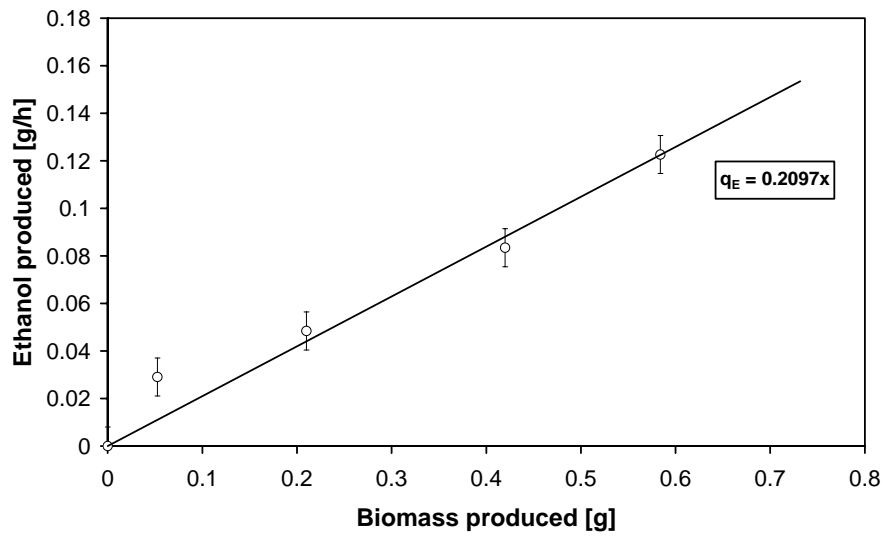

Figure 9. Specific ethanol productivity mixed-culture CEKI, composed of *K. marxianus* (S1), *I. orientalis* (S2) and *E. faecalis* (S3), grown at 30°C and pH 4 on 40 g/L whey permeate in the absence of solvent and stirred at 360 rpm.

5. Conclusions

An encapsulation method was designed for reducing solvent toxicity using alginate-based capsules (6% w/v), which also made solvent recovery from the extractive processes easier. It would represent an alternative to other ISPR methods as membrane distillation or vacuum fermentation, which use expensive membranes or require an important quantity of energy. Heat stability experiments demonstrated that ethanol could be recovered from the organic phase at 80°C but instability at 121°C would imply making the capsules under sterile conditions. In general heating resulted in an improvement of the ethanol diffusion coefficient because of the expulsion of water from the gel and thus a reduction of the membrane thickness. Characterization of the system behavior demonstrated that the alginate membrane was the main mass transfer limiting layer for encapsulated 2-ethyl-1-butanol and that in alginate-based / laurinaldehyde capsules it was the organic layer which was limiting.

A substantial reduction of the toxic effect of the solvent was observed by encapsulation of laurinaldehyde but no improvement could be demonstrated for 2-ethyl-1-butanol. This may either be due to the high toxicity of this solvent and/or due to the presence of extracapsular solvent resulting from the capsule production method. The extraction rate achievable using encapsulated laurinaldehyde was $3.17 \cdot 10^{-3} \text{ g}_{\text{EtOH}}/(\text{g}_{\text{solvent}} \cdot \text{s})$ which must be dimensioned for the specific ethanol production rate of $0.21 \text{ g}_{\text{EtOH}}/(\text{g}_{\text{biomass}} \cdot \text{h})$ for the consortium culture.

Encapsulated laurinaldehyde would thus be an alternative system to direct contact with oleyl alcohol for ethanol extraction. The partition coefficient of laurinaldehyde is twice larger than the one of oleyl alcohol, although phase toxicity prevents its direct utilization as an extractive solvent. Physical separation of the solvent from producing cells by an alginate polymer membrane enables the solvent toxicity to be overcome and thus opens the way to the use of laurinaldehyde and a wide range of similar solvents.

6. Nomenclature

b.p.	Boiling point	°C
D	Diffusion rate	$\text{g}\cdot\text{s}^{-1}$
EtOH	Ethanol	
G	α -L-guluronic acid	
ISPR	<i>In-situ</i> product recovery	
k	Diffusion coefficient	$\text{cm}^2\cdot\text{s}^{-1}$
L	Thickness of the membrane layer	cm
M	β -D-mannuronic acid	
MOPS	3-(N-morpholino)-propanesulfonic acid	
P	Partition coefficient	$C_{\text{orga}}\cdot C_{\text{aq}}^{-1}$
PCV	Packed cell volume	
PPG	Polypropylene glycol	
S	Exchange surface	cm^2
T	Temperature	°C
X	Cell dry weight	$\text{g}\cdot\text{L}^{-1}$
$Y_{j/i}$	Yield coefficient of substance j on substance i	$\text{C}\cdot\text{mol}\cdot\text{C}\cdot\text{mol}^{-1}$ $\text{g}\cdot\text{g}^{-1}$
YPL	Yeast extract-Peptone-Lactose rich medium	
Δc	Difference in concentration between inside and outside the membrane layer	$\text{g}\cdot\text{cm}^{-3}$

Subscripts

aq	Aqueous phase
E	Ethanol
exp	Obtained experimentally
i	Refers to compound i
j	Refers to compound j
M	Culture medium (whey permeate)
P	Refers to the produced ethanol
S	Refers to limiting nutrient
W	Water

7. References

- [1] Grobбен NG, Eggink G, Cuperus FP, Huizing HJ. Production of acetone, butanol and ethanol (Abe) from potato wastes: Fermentation with integrated membrane extraction. *Applied Microbiology and Biotechnology* 1993; 39: 494-498.
- [2] Roffler SR, Blanch HW, Wilke CR. In-situ recovery of fermentation products. *Trends in Biotechnology* 1984; 2: 129-136.
- [3] Daugulis AJ, Integrated reaction and product recovery in bioreactor systems. *Biotechnology Progress* 1988; 4: 113-122.
- [4] Szathmary S, Grandics P. Bioreactor integration with downstream processing. *Bio/Technology* 1990; 8: 924-925.
- [5] Giorno L, Leva L, Donato L, Drioli E. Development of an integrated membrane process for the production and downstream processing of carboxylic acids. In: *Biotechnology*. Berlin; 2000. p. 440-441.
- [6] Gu Z, Rickert DA, Glazt BA Glatz CE. Feasibility of propionic acid production by extractive fermentation. *Lait* 1999; 79: 137-148.
- [7] Takors R, Gerigk M, Maass D, Bongaerts J, Schmidt K, Sprenger G, Wubbolts M, Wandrey C. L-phenylalanine production in fed-batch fermentation with integrated product recovery using recombinant *E. coli* strains. In: *Biotechnology*. Berlin; 2000. p. 491-492.
- [8] Mattiasson B, Larsson M. Extractive bioconversion with emphasis on solvent production. *Biotechnology and Genetic Engineering Reviews* 1985; 3: 137-174.
- [9] Groot WJ, van der Lans RG, Luyben K. Technologies for butanol recovery integrated with fermentations. *Process Biochemistry* 1992; 27: 61-75.
- [10] Sandquist J, Blanch HW, Wilke CR. Vacuum fermentation. In: Mattiasson B, Holst O editors. *Extractive Bioconversions*. N.Y.: Marcel Dekker; 1991. p. 237-258.
- [11] Strathmann H, Gudernatsch W. Continuous removal of ethanol from bioreactor by pervaporation. *Bioprocess Technology* 1991; 11: 67-89.
- [12] Roffler SR, Randolph TW, Miller DA, Blanch HW Prausnitz JM. Extractive bioconversion with nonaqueous solvents. *Process Biotechnology* 1991; 11: 133-172.
- [13] Kaul R, Matthasson B. Extractive bioconversion in aqueous two phase systems. *Methods in Biotechnology* 2000; 11: 411-417
- [14] Linardos TI, Kalogarakis N Behie LA. Monoclonal antibody production in dialyzed continuous suspension culture. *Biotechnology and Bioengineering* 1992; 39: 504-510.
- [15] Fujii M Taniguchi M. Application of reversibly soluble polymers in bioprocessing. *Trend sin Biotechnology* 1991; 9: 191-196.
- [16] Mitsuda S, Matsuda Y, Kobayashi N, Suzuki A, Itagaki Y, Kumazawa E, Highashio K, Kawanishi G. Tissue plasminogen activator (t-PA) production by human fibroblasts using a bioreactor with t-PA adsorption column. *Bioprocess Engineering* 1991; 7: 137-140.
- [17] Shabtai Y, Chaimovitz S, Freeman A, Katchalski-Katzir E, Linder C, Nemas M, Perry M, Kedem O. Continuous ethanol production by immobilized yeast reactor coupled with membrane pervaporation unit. *Biotechnology and Bioengineering* 1991; 38: 869-876.

- [18] Yabannavar VM, Wand DIC. Strategies for reducing solvent toxicity in extractive fermentation. *Biotechnology and Bioengineering* 1991; 37: 716-722.
- [19] Davison BH, Scott CD. A proposed biparticle fluidized-bed for lactic acid fermentation and simultaneous adsorption. *Biotechnology and Bioengineering* 1992; 39: 356-368.
- [20] Stark D. Extractive bioconversion of 2-phenylethanol from L-phenylalanine by *Saccharomyces cerevisiae*. Switzerland: Swiss Federal Institute of Technology; Ph.D. thesis; 2001. p 129-163.
- [21] Daugulis AJ, Collins LD. Biodegradation of phenol at high initial concentrations in two phase partitioning batch and fedbatch bioreactors. *Biotechnology and Bioengineering* 1997; 55; 155-162.
- [22] Sikkema J, Debont JAM, Poolman B. Mechanisms of membrane toxicity of hydrocarbons. *Microbiology review* 1995; 59: 201-222.
- [23] Buittelaar RM, Vermue MH, Schlatmann JE, Tramper J. The influence of various organic solvents on the respiration of free and immobilized cell of *Tagetes minuta*. *Biotechnology Techniques* 1990; 4: 415-418.
- [24] Liu WH, Hornh WC Tsai MS. Bioconversion of cholesterol to cholest-4-en-3-one in aqueous/organic solvent two-phase reactors. *Enzyme and Microbial Technology* 1996; 18: 184-189.
- [25] Leon R, Fernandes P, Pinheiro HM, Cabral JMS. Whole-cell biocatalysis in organic media. *Enzyme and Microbial Technology* 1998; 23: 483-500.
- [26] Kollerup F, Daugulis AJ. Ethanol production by extractive fermentation–solvent identification and prototype development. *Canadian Journal of Chemical Engineering* 1986; 64: 599-606.
- [27] Bassetti L, Tramper J. Organic solvent toxicity in *Morinda citrifolia* cell suspension. *Enzyme and Microbial Technology* 1994; 16: 642-648.
- [28] Lilly MD, Brazier AJ, Hocknull MD, Williams AC Woodley JM. Biological conversions involving water-insoluble organic compounds. *Biocatalysis in organic media* 1987; Wageningen: 3-17.
- [29] Osborne SJ, Leaver J, Turner MK, Dunnill P. Correlation of biocatalytic activity in a n organic-aqueous two-phase system with solvent concentration in the cell membrane. *Enzyme and Microbial Technology* 1990; 12: 281-291.
- [30] VermueM, Sikkema J, Verheul A, Bakker R, Tramper J. Toxicity of homologous series of organic solvents for the gram-positive bacteria *Arthrobacter* and *Nocardia* Sp. and the gram-negative bacteria *Acinetobacter* and *Pseudomonas* Sp. *Biotechnology and Bioengineering* 1993; 42: 747-758.
- [31] Udriot H. Distillation transmembranaire. Switzerland: Swiss Federal Institute of Technology; Ph.D. thesis; 1990. p 7-46.
- [32] Breguet V. Alginate-based microcapsules for mammalian cell culture and other biotechnological applications. Switzerland: Swiss Federal Institute of Technology; Ph.D. thesis; 2007. p 129-168.
- [33] Takana I, Tosa T, Chibata I. Screening of matrix suitable for immobilization of microbial cells. *Journal of Solid Phase Biochemistry* 1977; 2(3): 225-236.
- [34] Kolot FB. Microbial carriers–Strategy for selection. *Process Biochemistry* 1981; 8; 2-9.

- [35] Phillips CR, Poon YC. Immobilization of Cells. In: Springer Verlag editors. *Biotechnology Monographs*. NY; 1988.
- [36] Kumamura M, Kaetsu I. Immobilization of cells by radiation copolymerization of hydrophilic and hydrophobic monomers. *Acta Chimica Hungarica* 1984; 116(4): 345-351.
- [37] Droulez C. Production d'éthanol à partir de lactose par une levure immobilisée, performances et limitations. Switzerland: Swiss Federal Institute of Technology; Ph.D. thesis; 1992. p 33-74.
- [38] Smidsröd O, Skjak-Braek G. Alginate as immobilization matrix for cells. *Tibtechnology* 1990; 8: 71-78.
- [39] Martinsen A, Skjak-Break G, Smodsröd O. Alginate as immobilization material – Correlation between chemical and physical properties of alginate gel beads. *Biotechnology and Bioengineering* 1989; 33: 79-89.
- [40] Vorlop KD, Klein J. New developments in the field of cell immobilization – Formation of biocatalysts by ionotropic gelation. *Enzyme Technology*. In: Springer Verlag. III Rotenburg Fermentation Symposium. NY; 1982.
- [41] Andresen IL, Skipnes O, Smodsröd O, Ostergaard K, Hemmer PC. Production of ethanol by immobilized yeast cells in alginate beads *AC Symposium series* 1977; 48: 361-381.
- [42] Johansen A, Flink JM. Influence of alginate properties and gel reinforcement on fermentation characteristics of immobilized yeast cells. *Enzyme and Microbial Biotechnology* 1986; 8: 737-748.
- [43] Offeman, RD, Stephenson SK, Robertson G.H, Orts WJ. Solvent extraction of ethanol from aqueous solution using biobased oil, alcohol and esters. *Journal of the American Oil' Chemists Society* 2006; 83: 153-157.
- [44] Offeman RD, Stephenson SK, Robertson GH, Orts WJ. Solvent extraction of ethanol from aqueous solutions. II. Linear, branched and ring-containing alcohol solvents. *Industrial and Engineering Chemistry research* 2005; 44: 6797-6803.
- [45] Matsumura M, Märkl H. Application of solvent extraction to ethanol fermentation. *Applied Microbiology and Technology* 1984; 20: 371-377.
- [46] Bruce LJ, Daugulis AJ. Solvent selection strategies for extractive biocatalysis. *Biotechnology Progress* 1991; 7: 116-124.
- [47] Hannoun BJ, Stephanopoulos G. Diffusion coefficients of glucose and ethanol in cell-free and cell-occupied calcium alginate membranes. *Biotechnology and Bioengineering* 1986; 28: 829-835.
- [48] Malinowski JJ, Daugulis AJ. Liquid-liquid and vapour-liquid behavior of oleyl alcohol applied to extractive fermentation processing. *The Canadian Journal of Chemical Engineering* 1993; 71: 431-436.
- [49] Cornelissen E R, Verdouw J, Gijsbertsen-Abrahamse AJ, Hofman J. A nanofiltration retention model for trace contaminants in drinking water sources. *Desalination* 2005; 178: 179-192.
- [50] Serp D. Whole cell immobilization from: insight tools to practical applications. Switzerland: Swiss Federal Institute of Technology; Ph.D. thesis; 2002.

Chapter 8

General Conclusions and Perspectives

1. General Conclusions

A recent EMPA study [1] compares ecological biofuels balances and depicts whey as the ideal raw material for bioethanol production, since it is characterized by the most important reduction in terms of greenhouse gas emissions and has the lowest environmental impact. Whey is a waste product which still needs to be valorized, when producing ethanol, ecological balance is positive and its utilization does not result in an increase of essential living raw materials resulting in recently reported problems, which are linked to extensive cultures, such as wheat or sugar cane [1].

The present work has revealed novel possibilities for ethanol production from whey permeate. Identification of key parameters of the production process resulted in a main effort on substrate stabilization, fermentation and ethanol recovery. A wide variety of ethanol producing microorganisms were characterized reporting optimal culture conditions, specific growth rate, ethanol inhibition and ethanol performance when cultivated with different qualities of substrate. Design of experiment methodology permitted to determine the influence of operating parameters and improve global productivity of the process. A consortium of *Kluyveromyces marxianus*, *Issatchenkia orientalis* and *Enterococcus faecalis* was presented as a promising ethanol producing alternative to pure cultures. Finally liquid-liquid and organic-aqueous two-phase systems were tested on this mixed culture for continuously extracting ethanol from the culture broth. Targeting a realistic valorization of whey permeate by Alcosuisse in Switzerland, the present study focused on practical and economical aspects of these newly investigated fields.

1.1 Substrate stabilization

For cheese industries, whey valorization represents a real logistical challenge because of the extreme instability of whey [2], which reduces significantly the number of possible valorization pathways, with the result that often considered being a waste product [3].

The preservation problem mainly results from the proliferation of lactic acid bacteria naturally present in whey, which breakdown the lactose and thereby reduce the amount of ethanol that can be produced. As a result transport and storage of whey are difficult; consequently

inexpensive methods to conserve the whey by addition of microbial growth inhibitors must be developed.

As a result, seven compounds, and a range of conditions, were tested for their ability to stabilize and inhibit bacterial growth in whey and whey permeate. The criteria used to select an ideal preservation agent for whey, when it is to be used in bioethanol production, were prevention of bacterial growth properties, high efficiency and non-interference with the alcoholic fermentation and/or ease of removal. Of these, hydrogen peroxide and formic acid were shown to successfully preserve the substrate over a period of three weeks at room temperature. This increase in terms of length of possible storage before utilizing whey and whey permeate for subsequent treatment significantly reduces the logistics and distribution constraints. When it is to be used in bioethanol production, stabilized whey must be non-toxic for ethanol producing cells. An inhibitory chemical for bacteria is often toxic for yeast cells and eliminating or withdrawing the preservative compound is required. The possible application of a whey stabilization strategy for producing ethanol by fermentation thus focuses on the simplicity of switching from inhibitory and non-toxic behavior of the stabilizing agent.

While a more complex procedure was needed to remove hydrogen peroxide from whey prior to ethanolic yeast fermentation, the fully dissociated form of formic acid was shown to be non-toxic for *K. marxianus* CBS 5795. Practically it means that by simply adjusting the pH prior to inoculation, *K. marxianus* was able to produce ethanol at least as efficiently as in the absence of formic acid.

Such a method should result in significantly improved process economics, since presently the use of whey and whey permeate to produce ethanol is limited to large dairies which must use the permeate directly after production [4-6]. Small producers' production can now be integrated with respect to raw matter availability and storage of large volumes at room temperature thus saving important energy costs.

1.2 Optimal batch strategy for the production of ethanol

Industrial-scale whey-ethanol plants are spread around the world. In the United States, at Corona, and Melrose, production plants were developed in the 1980s [7]. The whey-to-ethanol plant commissioned in 1978 by Carbery Milk Products Ltd. of Ireland is believed to be the first modern commercial operation to produce potable (drinkable) alcohol [8]. Since

1985, it has also produced fuel ethanol in a process adopted by New Zealand in August 2007. Fruteau de Laclos and Membrez (EREP, 2004) present the performance of a typical ethanol fermentation process with ethanol production yields of less than 70% of theoretical conversion yield and highest achievable ethanol concentration of 5% (v/v) [9]. Despite the increasing requirement for process optimization, these processes are built on old fermentation technologies and important improvements can be envisaged [8]. A computer simulated case-study, reported in chapter 2, showed that direct fermentation of whey by lactose-utilizing yeasts or fermentation of hydrolyzed whey by different yeast species resulted in equivalent production costs. Developing a production strategy thus requires careful evaluation of these two fermentation modes, and must be followed by selecting appropriate microorganisms. To this end, the ethanol performance of eight yeasts was compared to define the most appropriate strain for ethanol production from whey. Selection criteria for this characterization, made in batch mode, were: high ethanol conversion efficiency ($Y_{P/S}$), high ethanol tolerance ($C_{EtOH,max}$) and high productivity (Q_P). The best improvement potential was obtained by direct whey permeate fermentation with *K. marxianus* CBS 5795 whose (i) ethanol production yield almost reaches theoretical values, (ii) maximum productivity $Q_{p,max}$ of 6.15 g_{EtOH}/(L·h) was measured, (iii) resistance was 79 g/L ethanol before stopping fermentation. Comparison of these results with reported industrial ethanol performance, the improvement on fermentation step is in the range of 35-40% while increasing ethanol percentage in the medium by a factor two reduces the working volume and thus energy expense by a corresponding amount. Finally the optimization of fermentation and pre-culture conditions identified critical parameters which permitted to significantly reduce the lag phase period in CBS 5795 batch cultures and thus improve by 11% global productivity of the fermentation procedure. Using similar tools to those in chapter 2, up-dated production costs for centralized direct fermentation of concentrated whey permeate (22% DM) can be estimated (Table 1). Whey was stabilized with 3 mL formic acid /L, concentrated to produce whey permeate, and transported to an optimized fermentation facility, where CBS 5795 produced 0.530 g_{EtOH}/g_{lactose}, after pH adjustment for removing of the bactericidal effect of formic acid. Further distillation to 93% (v/v) followed by a dehydration step could produce 9.1·10⁶ L/year compared to of 6.7·10⁶ L/year with non-optimized process [9]. A main objective of this project was to reduce production costs to approximately 1 CHF/L_{EtOH}. This goal seems to be achievable by the use of some of the advances brought to the fore in this work, in which a production cost of 0.95 CHF/L_{EtOH} would be obtained (Figure 1).

Table 1. Annual operating costs for ethanol production from whey permeate in a centralized production plant including direct lactose fermentation using *Kluyveromyces marxianus* CBS 5795. 22% DM concentrated whey permeate is stabilized with 3 mL/L formic acid prior to transport and is subsequently neutralized just prior to fermentation with NaOH. Ethanol conversion yield is 0.530 g_{EtOH}/g_{lactose} and ethanol concentration of 10% v/v is achieved after fermentation, resulting in yearly production of 9.1·10⁶ L ethanol.

	Concentration	Stabilization	Transport	Fermentation	Distillation	Dehydration	Total
ANNUAL OPERATING COST (2004 prices)							
A. DFC-DEPENDENT ITEMS	cost (CHF)	cost (CHF)	cost (CHF)	cost (CHF)	cost (CHF)	cost (CHF)	cost (CHF)
	676'000	0 ¹	0 ²	783'000	325'000	486'000	
B. LABOR-DEPENDENT ITEMS	1'439'000	0 ¹	0 ²	490'000	163'000	163'000	
C. ADMINISTRATION AND OVERHEAD EXPENSE (0.6 · (a+b+c))	688'000	0 ¹	0 ²	229'000	76'000	76'000	
D. RAW MATERIALS							
a. Carbon source (0 CHF/tonne)							
b. NaOH (360 Srf/tonne)	1'000			108'000			
c. H ₂ SO ₄ (320 Srf/tonne)	1'000			41'000			
d. others	0	546'000		29'000			
	2'000	546'000	0	178'000	0	0	
E. OTHER CONSUMABLES							
Membrane or filter cloth	42'000	0	0	0	0	0	
F. UTILITIES							
a. Steam (50 Srf/tonne)	7'000 ³				426'000 ³	165'000 ³	
b. Water (0.15 Srf/tonne)	14'000 ³			7'000 ³			
c. Energy (100 CHF MWh)	235'000 ³	0		60'000 ³	13'000 ³	4000 ³	
	256'000	0	0	67'000	439'000	169'000	
G. WASTE TREATMENT/DISPOSAL (2 Srf/tonne)	9'000	0	0	0	13'000 ³	0	
H. TRANSPORT (0.31 CHF/tonne km)	0	0	2'747'000	0	0	0	
I. BY PRODUCT VALORIZATION	-1'388'000	0	0	0	0	0	
Total annual operating cost	1'724'000	546'000	2'747'000⁴	1'747'000	1'016'000	894'000	8'674'000

¹ it was assumed that local milk-producers already possess the necessary heat-exchange units

² expenses related to vehicles and salaries are already comprised in the transport costs

³ values obtained by simulations with ASPEN Plus

⁴ non-refrigerated transport costs were assumed to be identical to refrigerated

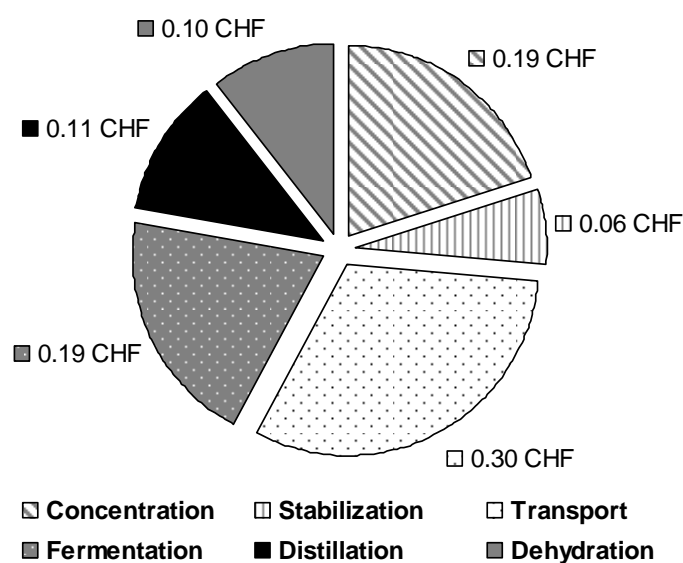

Figure 4. Contribution of the individual operating units with the advancements identified in this work.

1.3 Advantage of mixed cultures

Combining the advantages of multiple organisms has been widely applied in biotechnology [10-14]. In this work it was shown that a mixed culture of *Kluyveromyces marxianus*, *Issatchenkia orientalis* and *Enterococcus faecalis* enhanced the global fermentative process. While pure cultures of these microorganisms provided in batch culture lower ethanol performances, their combination resulted in a cost effective and stable behavior of the system. *K. marxianus* was shown to be the most efficient organism for ethanol production. *I. orientalis* also produced ethanol but its higher ethanol tolerance enabled longer fermentation periods which resulted in an improvement of the global productivity. Finally *E. faecalis* demonstrated a protective activity against possible contaminants without negatively influencing development of the co-cultured yeasts. The highest ethanol performance parameters were obtained using a mixed culture, grown at pH 4 and 30°C from 40g/L whey permeate, with an ethanol production yield of 0.65 C-mol ethanol /C-mol lactose and a volumetric productivity of 1.85 g_{EtOH}/(L·h) or a specific ethanol production rate of 0.21 g_{EtOH}/(g_{biomass}·h).

The main advantage of this mixed-culture consists in its protective properties, which enable new production strategies because fermentation procedure requires the control of many

operating conditions. While efforts were undertaken to ensure stabilization of the substrate until a centralized treatment center, fermentation at the production site seems to be possible without expensive control equipment and specific know-how of the operators. Costs of individual production steps are listed in chapter 2. Transport and fermentation were reported to be the most important expenses in the global process. By fermenting whey with a less demanding procedure and pre-concentrating ethanol up to 60-70% (v/v) with distillation units could result in (i) solving substrate stability problems, (ii) reduced storage costs, and (iii) decreased transported volumes. Pre-distillation up to such concentrations requires few equilibrium stages and thus small distillation columns but high purification constraints for biofuel applications will still require a centralized distillation and dehydration plant.

1.4 Novel ISPR system for liquid-liquid extraction

Inhibitory effect of ethanol on growing cultures is often the principle limitation of a fermentation process [15-18]. Continuous removal of the inhibitory product thus enables higher system productivity and helps lowering energy costs by reducing working volumes [19-20]. The application of organic solvents for *in-situ* product recovery by a mixed culture producing ethanol was shown to have an important improvement potential in fermentation technology. The high hydrophilic behavior of ethanol in an aqueous phase makes difficult to find organic solvents with a partition coefficient higher than 1 and which do not negatively influence yeasts growth by direct contact. Only oleyl alcohol did not result in visible toxicity for the microorganisms and is therefore depicted in many articles as the reference solvent for ethanol extraction even though it has a $P_{E/W}$ partition coefficient of only 0.31 [21-22]. As a maximum $P_{E/M}$ of 1.65 could be measured in all examined solvents, it was thus important to examine solvents with the highest possible $P_{E/M}$ partition coefficient. The toxicity of most of efficient solvents prevented their use for further fermentation experiments, however laurinaldehyde ($P_{E/M} = 0.81$) only affected the system by forming an emulsion with the culture broth, while 2-ethyl-1-butanol ($P_{E/M} = 1.27$) inhibited cell growth but not ethanol production. An encapsulation method was designed for reducing solvent toxicity using alginate-based capsules (6% w/v), which also made solvent recovery easier. A substantial reduction of the toxicity of the solvent was observed by encapsulation of laurinaldehyde, while no improvement could be demonstrated with 2-ethyl-1-butanol. The extraction rate achievable with encapsulated laurinaldehyde system was $3.17 \text{ g}_{\text{EtOH}}/(\text{g}_{\text{solvent}} \cdot \text{s})$ which allows dimensioning an extractive process, which for the mixed cultures is characterized by specific ethanol

production rate of $0.21 \text{ g}_{\text{EtOH}}/(\text{g}_{\text{biomass}}\cdot\text{h})$. Ethanol recovery of such an encapsulated system would be easier since the organic phase contained the extracted ethanol is easier to separate from the fermentation broth. Figure 2 shows a possible set-up for continuous ethanol recovery from encapsulated laurinaldehyde. In this system an external cyclone retains the capsules from the fermentation broth. Ethanol is recovered from the capsules by heating them at ethanol boiling point. Proven stability of the capsules at 80°C enables recycling capsules, which are re-introduced in the fermentation vessel. Further characterization and normalization of hydrophobic core capsule production remains to be investigated.

Laurinaldehyde was thus demonstrated to be a promising alternative to oleyl alcohol for aqueous-organic extraction [23] and a novel encapsulation methodology was successfully applied to overcome the negative effects on the microbial population.

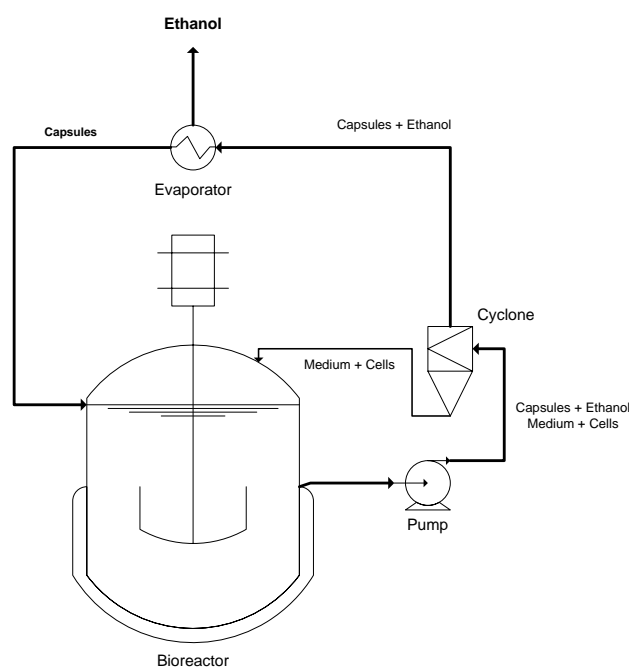

Figure 2. Flow chart of ethanol recovery from an encapsulated organic phase. The capsules are separated from the culture broth by a cyclone and heated to recover ethanol. Ethanol-free capsules are then recycled.

2. *Perspectives*

This project describes the characterization and optimization of ethanol production from whey and whey permeate in batch mode. Through global economic evaluation of the process, some upstream and downstream operation units were investigated and modeled. However, a broad range of possibilities still offer improvement potential or better adaptation to other geographic cases. Focusing on batch fermentation allows for more flexible operating conditions [24], which is particularly important when using whey as a substrate, since it is produced once a day and its preservation presented a major constraint [25]. The objective of complementing Swiss fuel with 5% (v/v) of bioethanol [9-10] is a huge challenge and would require much larger quantities of whey than are currently produced [25]. For this reason previous studies have considered the available amounts of other waste-products such as grass, potatoes, sugar beets and old papers, as possible substrates [9-10]. Use of mixtures of raw materials would enable a large-scale multi-substrate bioethanol plant to be designed.

While batch fermentation allows more flexible operating conditions, continuous fermentation processes play a more important role in large-scale industry [26-27]. Continuous processes permit to obtain higher productivities not only because the system operates at a higher and stable biomass concentration compared to standard batch processes but also because no dead time for filling or emptying is required. This higher productivity results in a reduction of the size of the fermentation vessel and the possible automation of such systems, which also reduces operating costs [28]. Working parameters however still need to be defined for transposing actual data to a continuous process. Flow rate, vessel dimension and dilution rate must be defined in order to achieve the highest biomass in the chemostat, desired productivity, medium complements and final ethanol production. Finally deciding which of the continuous set-ups will be chosen among, simple chemostat [29-30] or combination with retention devices chemostat including cell recycle [31], membrane [32], cell-immobilization [33-34] or internal spin-filter [35].

The incorporation of various substrates leads to three main strategies. The first transforms the different complex carbon sources into a common easy assimilated monosaccharide which is fermented by one microorganism. The second uses multiple fermentation steps, at the same time or one after the other, and specific microorganisms ferment the different substrates. Finally a mixed-culture of these specific microorganisms ferments all mixed substrates at the same time. *Zymomonas mobilis* could be an alternative to *E. faecalis* in mixed-cultures, as it was reported to have similar protective activity and exhibits more efficient ethanol performance [12- 14]. Another advantage would be the non-dependency to temperature as it

was presented using *E. faecalis*, since an increase of the temperature during the process would result in an important lactic acid production.

While individual fermentation data are available for the fermentation of most pre-cited raw materials, it will only be possible to assess the behavior of the resulting mixture of diverse species by experimental cultures. Numerous combination possibilities are still to be tested and a real potential can be imagined for simultaneous multi-substrate fermentation.

In addition, the development of new technologies for up- and downstream processing must be sought. Membrane processes such as pervaporation are currently available for overcoming the ethanol-water azeotrope and could be applied to ethanol solutions of 70-80% (v/v), which would reduce significantly distillation columns dimensions and result in a positive energy, economic and ecologic balance of the process [36]. Nowadays, membrane life is a major drawback for these types of technologies since their price weighs heavily in the budget but pervaporation is continuously improving and catching-up with mature technologies such as distillation.

Liquid-liquid extraction was chosen as an ISPR technology but there are other techniques which could also be investigated for ethanol recovery, such as membrane distillation, which allows recovery of very pure ethanol directly from the fermentation broth without using usual distillation / dehydration processes [37-38]. This functions using a gradient of vapour pressure induced by a difference of temperature, such that ethanol evaporates through a selective membrane.

Conclusively, there is still potential for improving the ethanol production from whey and whey permeate and this work contributed to long-term stabilization of the substrate, established and optimized the operating conditions for interesting organisms or combination of organisms, presented an novel economical model for production costs estimation; and investigated non-sterile ethanol production and *in-situ* ethanol recovery.

3. References

- [1] Zah R, Böni H, Gauch M, Hischier R, Lehmann M, Wäger P. Ökobilanz von Energieprodukten. In: Bundesamt für Energie, Umwelt und Landwirtschaft. Ökologische Bewertung von Biotreibstoffen. St. Gallen: 2007.
- [2] Marwaha SS, Kennedy JF. Review: whey-pollution problem and potential utilization. *International Journal of Food Science & Technology* 1988; 23: 323-336.
- [3] Mawson AJ. Bioconversions for whey utilization and waste abatement. *Bioresource Technology* 1994; 47: 195-203.
- [4] Kemp DL, Quickenden J. Whey processing for profit - a worthy alternative. In: Greenshield R editors. Resources and applications of biotechnology- the new wave. Basingstoke: Macmillian; 1989. p. 323-331.
- [5] Kargi F, Ozmihci S. Utilization of cheese whey powder for ethanol fermentations: effects of operating conditions. *Enzyme and Microbial Technology* 2006; 38: 711-718.
- [6] Fiduciaire de l'économie laitière S.à.r.l., editor. Statistique laitière de la Suisse. Brougg: Secrétariat de l'Union Suisse des paysans; 2006.
- [7] Craig A, Mark N. An Economic Analysis of the US Market for Lactose. In: Conference on Dairy Markets and Product Research. Cornell Program on Dairy Markets and Policy. Cornell: March 2002.
- [8] Ling KC. Whey to ethanol: a biofuel role for dairy cooperatives. In: Rural Business and Cooperative Programs. Research Report 214. Washington: USDA; 2008. p. 17-18.
- [9] Fruteau de Lacroix H, Membrez Y. Energie à partir de petit-lait: comparaison des filières biogaz et bioéthanol. In: Programme de recherche énergétique, biomasse. Office fédéral de l'énergie (OFEN). Aclens: EREP; 2004.
- [10] Delgenes JP, Escare MC, Laplace JM, Moletta R, Navarro JM. Biological production of industrial chemicals, i.e. xylitol and ethanol, from lignocelluloses by controlled mixed culture systems. *Industrial Crop and Products* 1998; 7: 101-111.
- [11] Murado MA, Pastrana L, Vazquez JA, Miron J, Gonzalez MP. Alcoholic chestnut fermentation in mixed culture. Compatibility criteria *Aspergillus oryzae* and *Saccharomyces cerevisiae* strains. *Bioresource Technology* 2008; 99: 7255-4263.
- [12] Gonzalez C, Delgado O, Baigori M, Abate C, de Figueroa LIC, Callieri DA. Ethanol production from native cassava starch by a mixed-culture of *Endomycopsis fibuligera* and *Zymomonas mobilis*. *Acta Biotechnologica Polonica* 1998; 18(2): 149-155.
- [13] Kim DH, Hong YA. Co-fermentation of grape must by *Issatchenkia orientalis* and *Saccharomyces cerevisiae* reduces the malic acid content in wine. *Biotechnology Letters* 2008; 30: 1633-1638.
- [14] Abate C, Callieri D, Rodriguez E, Garro O. Ethanol production by a mixed culture of flocculent strains of *Zymomonas mobilis* and *Saccharomyces* sp. *Applied Microbial Biotechnology* 1996; 45: 580-583.
- [15] Fonseca GG, Gombert AK, Heinzle E, Wittmann C. Physiology of the yeast *Kluyveromyces marxianus* during batch and chemostat cultures with glucose as the sole carbon source. *FEMS Yeast Resource* 2007; 7: 422-435.

- [16] Fonseca GG, Henzle E, Wittmann C, Gombert A. The yeast *Kluyveromyces* and its biotechnological potential. *Applied Microbial Technology* 2008; 79: 339-354.
- [17] Xue C, Zhao XQ, Yuan WJ, Bai FW. Improving ethanol tolerance of a self-flocculating yeast by optimization of medium composition. *World Journal of Microbiology and Biotechnology* 2008; 24: 2257-2261.
- [18] Rosa FM, Sa-Correia I. Ethanol tolerance and activity of plasma membrane ATPase in *Kluyveromyces marxianus* and *Saccharomyces cerevisiae*. *Enzyme and Microbial Technology* 1992; 14: 23-27.
- [19] Roffler SR, Blanch HW, Wilke CR. *In-situ* recovery of fermentation products. *Trends in Biotechnology* 1984; 2: 129-136.
- [20] Mattiasson B, Larsson M. Extractive bioconversion with emphasis on solvent production. *Biotechnology and Genetic Engineering Reviews* 1985; 3: 137-174.
- [21] Offeman, RD, Stephenson SK, Robertson G.H, Orts WJ. Solvent extraction of ethanol from aqueous solution using biobased oil, alcohol and esters. *Journal of the American Oil' Chemists Society* 2006; 83: 153-157.
- [22] Offeman RD, Stephenson SK, Robertson GH, Orts WJ. Solvent extraction of ethanol from aqueous solutions. II. Linear, branched and ring-containing alcohol solvents. *Industrial and Engineering Chemistry research* 2005; 44: 6797-6803.
- [23] Malinowski JJ, Daugulis AJ. Liquid-liquid and vapour-liquid behavior of oleyl alcohol applied to extractive fermentation processing. *The Canadian Journal of Chemical Engineering* 1993; 71: 431-436.
- [24] Brown G. Flexibility in batch control. *Control and Instrumentation* 1998; 30(9): 63-64.
- [25] Krummenacher P, Kern M. Développement d'une filière de carburant au bioéthanol. In : Bonnard and Gardel. Internal Report. La Sagne : Planair ; 2002.
- [26] Verduyn C, Postma E, Sheffers WA, van Dijken JP. Effect of benzoic acid on metabolic fluxes in yeast: a continuous culture study on the regulation of respiration and alcoholic fermentation. *Yeast* 1992; 8: 501-517.
- [27] Dale MC, Moelhma M, Walker S. Industrial scale production of ethanol from whey permeate mother liquor using a multi-stage continuous fermentation system. *Paper American Society of Agricultural Engineers* 1997; 3: 1-10.
- [28] Andres-Toro B, Giron-Sierra JM, Lopez-Orozco JA. A kinetic model for beer production under industrial. *Mathematics and Computer in Simulating* 1998; 48(1): 65-74.
- [29] Ghaly AE, El-Taweel AA. Kinetic modelling of continuous production of ethanol from cheese whey. *Biomass and Energy* 1997; 12(6): 461-472.
- [30] Ozmihci S, Kargi F. Effects of feed sugar concentration on continuous ethanol fermentation of cheese whey powder solution (CWP). *Enzyme and Microbial Technology* 2007; 41: 876-880.
- [31] Chang HN, Kim BJ, Kang JW, et al. High cell density ethanol fermentation in an upflow packed-bed cell recycle bioreactor. *Biotechnology and Bioprocess Engineering* 2008; 13(2): 123-135.
- [32] Henning DR, Baer RJ, Hassan AN, Dave R. Major advances in concentrated and dry milk products, cheese, and milk fat-based spreads. *Journal of Dairy Science* 2006; 89: 1179-1188.

- [33] Brady D, Nigam P, Marchant R, McHale AP. Ethanol production at 45°C by alginate-immobilized *Kluyveromyces marxianus* IMB3 during growth on lactose-containing media. *Bioprocess Engineering* 1997; 16: 101-104.
- [34] Gianetto A, Berruti F, Glick BR, Kempton AG. The production of ethanol from lactose in a tubular reactor by immobilized cells of *Kluyveromyces fragilis*. *Applied Microbiology and Biotechnology* 1986; 24: 277-281.
- [35] Moon H, Lim DJ, Song GY, et al. A new spin filter for high density culture and ethanol production by *Saccharomyces cerevisiae*. *Journal of Microbiology and Biotechnology* 2002; 12(3): 406-410.
- [36] Malgorzata L, Kujawski W. Ethanol production from lactose in a fermentation/pervaporation system. *Journal of Food Engineering* 2007; 79: 430-437.
- [37] Rivier C. Étude de la distillation transmembranaire à entraînement gazeux pour la séparation de mélanges azéotropiques aqueux. Switzerland: Swiss Federal Institute of Technology; Ph.D. thesis; 1998.
- [38] Udriot H. Distillation Transmembranaire – Etude d'un procédé de séparation à membrane et développement de nouveaux champs d'application. Switzerland: Swiss Federal Institute of Technology; Ph.D. thesis; 1990.

Curriculum Vitae

François-Nicolas de Glutz

Swiss citizen (Solothurn, SO)
Born in April 9th, 1981 in Zurich

Education	
2005-2009	PhD in Biotechnology Laboratoire de Génie Chimique et Biologique and Laboratoire de Biotechnologie Environnementale Swiss Federal Institute of Technology, Lausanne (EPFL) Price PhD student 2006
2007	Venture Challenge entrepreneurship course Université de Lausanne (UNIL) Master in Biotechnology
2003-2004	Master in Biotechnology Laboratory of Biotechnology and Bioengineering Swiss Federal Institute of Technology, Zurich (ETHZ)
1999-2003	Bachelor in Chemical Engineering Swiss Federal Institute of Technology, Lausanne (EPFL)
1997-1999	High School, certificat de maturité ès sciences , type C Gymnase Auguste Piccard, Lausanne Price of German, Goethe-Institut
Professional Experiences and Internships	
2005-2008	Alcosuisse : characterization and optimization of bioethanol production from whey permeate in Switzerland. This CTI-PhD project brought solutions to substrate stabilization problems, micro organisms selection and production pathway questions.
2005-2009	Swiss army : commanding first a platoon (30 troops) then a company (200 troops) helped me develop adaptability and leadership skills associated to human communication.
2005-2008	Supervisor of two master project students and three trainees.
2005-2006	Assistant of Separation Processes, master course, EPFL.

	2005	Logistics support of the Biothermodynamics seminar in Mürren.
	2004	Professional communication internship (Moudon).
Languages	French:	mother tongue
	English:	very good knowledge oral and written (C1 + level)
	German:	very good knowledge oral and written (C1 level)
	Italian:	very good knowledge oral and written (C1 level)
	Spanish:	good knowledge oral (B1 + level)
Publications	2004	Weber W, Rinderknecht M, Baba MD, de Glutz FN, Aubel D, Fussenegger M. CellMAC: a novel technology for encapsulation of mammalian cells in cellulose sulfate/pDADMAC capsules assembled on a transient alginate/Ca ⁽²⁺⁾ scaffold. <i>Journal of Biotechnology</i> 2004 Nov 9; 114(3): 315-26.
	2005	Weber W, Rimann M, de Glutz FN, Weber E, Memmert K, Fussenegger M. Gas-inducible product gene expression in bioreactors. <i>Metabolic Engineering</i> 2005 May; 7(3): 174-81.
	2008	de Glutz FN, Viscasillas C, von Stockar U, Holliger C, Marison IW. Stabilization of whey permeate to enable ethanol production by <i>Kluyveromyces marxianus</i> . <i>Process Biochemistry</i> , submitted paper.
	2009	de Glutz FN, Holliger C, Marison IW. Enhancement of ethanol productivity by controlling pre-culture conditions. <i>Process Biochemistry</i> , submitted paper.
	2009	de Glutz FN, Hugonnet M, Holliger C, Marison IW. <i>In-situ</i> product recovery of ethanol by an organic-aqueous two-phase extraction system. <i>Biotechnology Progress</i> , submitted paper.
	2009	de Glutz FN, Holliger C, Marison IW. Ethanol fermentation of whey permeate and hydrolyzed whey permeate: yeast strain selection and performance optimization. <i>Bioresource Technology</i> , submitted paper.
	2009	de Glutz FN, Holliger C, Marison IW. Process design and economic evaluation for ethanol production from cheese whey. <i>Journal of Dairy Science</i> , submitted paper.
	2009	de Glutz FN, Hugonnet M, Oertlé E, Holliger C, Marison IW. Mixed-culture fermentation of non-sterile whey permeate. <i>Enzyme and Microbial Technology</i> , submitted paper.

Personal Interests

Music-Dance: Piano, Salsa

Sport: Rowing (Vogalonga, 2h15)
Running (20km of Lausanne: 43'36", 10 km; 1h49'13", 20 km)
Athletics (5x80m, Athletissima 1996; javelin throw, Vaud champion 1997; discus throw, Vaud champion 1996-7 ; shot put, Swiss record 1997)
Motor bike
