

Received February 18, 2015, accepted April 6, 2015, date of publication April 9, 2015, date of current version April 21, 2015.

Digital Object Identifier 10.1109/ACCESS.2015.2421505

Diversity Gain Influenced by Polarization and Spatial Diversity Techniques in Ultrawideband

MOHSEN KOOHESTANI^{1,2}, AHMED HUSSAIN³, ANTONIO A. MOREIRA²,
AND ANJA K. SKRIVERVIK¹

¹Laboratoire d'Electromagnétisme et d'Acoustique, École Polytechnique Fédérale de Lausanne, Lausanne 1015, Switzerland

²Instituto de Telecomunicações, Instituto Superior Técnico, Universidade de Lisboa, Lisbon 1049-001, Portugal

³Department of Signals and Systems, Chalmers University of Technology, Gothenburg 412 58, Sweden

Corresponding author: M. Koohestani (koohestani.mohsen@ist.utl.pt)

This work was supported by the Fundação para a Ciência e a Tecnologia under Project UID/EEA/50008/2013.

ABSTRACT This paper presents an experimental investigation of diversity gain influenced by polarization and spatial diversity techniques in ultrawideband (UWB) radio technology. To this aim, two different coplanar-fed UWB diversity antennas having the same size and employing identical monopoles were taken and both effective and apparent diversity gain were measured in a reverberation chamber. To extract the diversity gain, three commonly used approaches to combine diversity (i.e., selection, equal gain, and maximal ratio) have been considered. Results showed that >1 dB (~26%) improvement in diversity gain is obtained over most of the considered band for polarization diversity case as compared with spatial case, showing the usefulness of polarization diversity for future UWB diversity applications.

INDEX TERMS Diversity gain, polarization and spatial, UWB diversity antenna, reverberation chamber.

I. INTRODUCTION

Diversity proved to be an effective solution to mitigate multipath fading signals and enhance the system capacity. The most popular diversity technique is the antenna diversity which can be classified as spatial/space, polarization and pattern diversities [1], [2]. It is widely used in body-centric wireless communications due to offering significant improvements for instance for the on-body channels [3], [4]. Moreover, it can benefit from ultra-wideband (UWB) radio technology due to its large bandwidth which improves the number of channels allowing higher data rates and resolution (see for instance [5]). This also facilitates the compatibility of such technology in body-centric applications. There are some studies presented in the literature investigating the benefits of employing spatial or polarization diversity techniques. For instance, in [6] the spatial diversity has been investigated as it doesn't need any additional spectrum whereas in [7] with the motivation of having high isolation considering the smaller space needed and the reduced cost for installation the polarization diversity was preferred.

Diversity gain (DG) is a measure of reliability, estimating the decays of error probability with the increase of signal-to-noise ratio (SNR) at a given outage probability. Recently, another term, *i.e.* effective DG, has been introduced as an absolute value of DG enabling the comparison between different diversity antennas [8]. In classical narrow-band applications, spatial diversity is a common

method to combat fading [9]. The study presented in [10] has shown that, under the considered conditions, the DG brought by spatial diversity is about 0.7 dB more important than the one brought by polarization diversity. Moreover, results in [7] have shown that the aperture-coupled patch provides at least 1.5 dB more DG compared to a slanted dipole configuration. Regarding the DG in UWB case, the studies in [6] and [11] investigate the DG for on- and off-body communications with the antenna employing spatial diversity. In [12], an experimental study of both spatial and polarization diversity with multiple-input-multiple-output (MIMO) antennas has been presented for body-centric applications. However, no DG discussion and result were provided. To the authors' knowledge the influence of UWB spatial and polarization diversities on DG has been unreported.

In this paper, an investigation of DG influenced by both spatial and polarization diversities has been performed in the frame of a specific UWB scenario. For this purpose, two UWB diversity antennas having the same size and employing identical monopoles were taken and both effective and apparent DGs were measured in a reverberation chamber.

II. DIVERSITY GAIN CONCEPTS

Diversity gain definition is conditioned by the probability that the SNR is above a reference level.

Mathematically, its general expression is [13]

$$DG = \left[\frac{\gamma_c}{\Gamma_c} - \frac{\gamma_1}{\Gamma_1} \right]$$

where γ_c is the instantaneous SNR of the diversity combined signal, Γ_c is the mean SNR of the combined signal, γ_1 is the highest SNR of the diversity branch signals, and Γ_1 is the mean value of γ_1 .

The received power level in a multipath environment with no line of sight is statistically distributed as a Rayleigh function [8]. Moreover, in a diversity scheme with two branches, the received power from each of them will have a Rayleigh-shaped probability density function. For this, the probability that an arbitrary power level sample is smaller than a certain power level; that is, the cumulative distribution function (CDF) is plotted. To this aim, the squared power samples ($|S_{21}|^2$) are simply sorted and then the series on the x axis against i/N on the y axis are plotted (where i is the index of the sorted series ranging from 1 to N).

Theoretically, the difference between the strongest channel trace and the combined signal represents the DG for each different combining technique, for a fixed level of the CDF of the received signals [14]. In order to optimize the SNR in a diversity scheme, the output signals can be combined in several ways such as selection combining (SC), equal gain combining (EGC), and maximal ratio combining (MRC) [15].

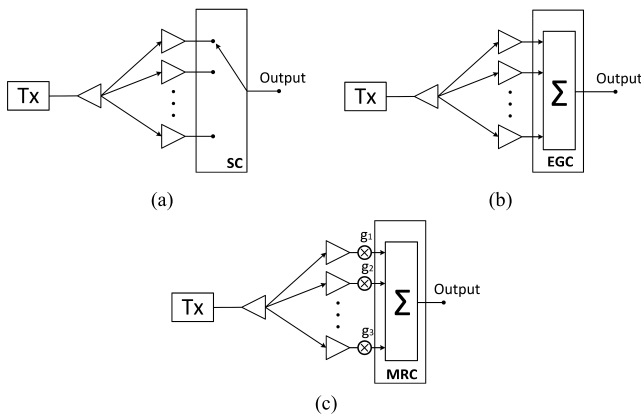

FIGURE 1. Three common methods of combining signals: (a) SC; (b) EGC; and (c) MRC.

A. SELECTION COMBINING

It selects the strongest received signal in branches [16], [17]. Fig.1a shows the SC block-diagram. The key idea is that, at any given moment of time, it picks up the branch with the highest SNR. Note that to provide same SNR for each branch, a number of modulators are required to adjust the gain of each diversity branch.

B. EQUAL GAIN COMBINING

It gain all received signals with the same values and coherently combines all [16], [17]. Fig.1b shows the EGC block diagram. The key idea is that it linearly combines

the branch signals which leads to a high SNR output stronger than each branch signal. Note that all signals are co-phased to provide equal gain combining.

C. MAXIMAL RATIO COMBINING

It gains more in better branches and gains less in bad branches [16], [17]. Fig.1c shows the MRC block diagram. The key idea is that it uses linear coherent combining of the branch signals which leads to the maximized SNR output. Note that all signals must be co-phased before being summed. This requires a phasing circuit for each antennas element.

If the two received levels are combined according to a certain diversity combination rule, the diversity gain relative to the reference branch, can then be expressed as [8]:

$$DG = \frac{P_{div}}{P_{branch}}$$

where P_{div} is the power level after diversity combining, and P_{branch} is the power level of the reference branch. The two power levels must be read at the same cumulative probability level, which normally is taken to be 0.01; that is, 1%. It should be noted that the cumulative power distribution for the combined case will be located to the right of the curves for the two branches. DG is a useful tool for evaluating the diversity performance, but it might not express the reality. In reality, the antenna performance encounters different losses, accumulated in the antenna radiation efficiency. Recently, another term, *i.e.* effective DG, has been introduced which is an absolute measure of DG [8]. It also enables comparing the DG of different diversity antennas. It can be mathematically expressed as:

$$DG_{effective} = \left[\frac{P_{div}}{P_{branch}} \right] \cdot \eta_{radiation} = \left[\frac{P_{div}}{P_{ideal}} \right]$$

where $\eta_{radiation}$ is the radiation efficiency of the reference branch, and P_{ideal} is the received power level of a single antenna with unit radiation efficiency and located in the same environment. P_{div} and P_{branch} must also be measured at the same cumulative probability levels. In a CDF plot, the effective diversity gain can be seen as the difference along the abscissa axis between the ideal reference and the diversity curve at some specific outage probability.

III. ANTENNA STRUCTURE AND DESIGN

To be able to study the spatial and polarization effects on DG and to have a fair comparison, we have designed a new dual-port coplanar waveguide-fed (CPW) UWB diversity antenna having the same size ($27 \times 52 \times 1.57 \text{ mm}^3$) and identical monopoles as the polarization diversity antenna reported in [18] but employing spatial diversity. In this case, the space between the two branches is 8 mm. The detailed design of the polarization diversity antenna was presented in [18]. Photographs of both prototypes are shown in Fig. 2. For the rest of this paper and to simplify the descriptions, the spatial and the polarization UWB diversity antennas will be referred to as SP and POL, respectively.

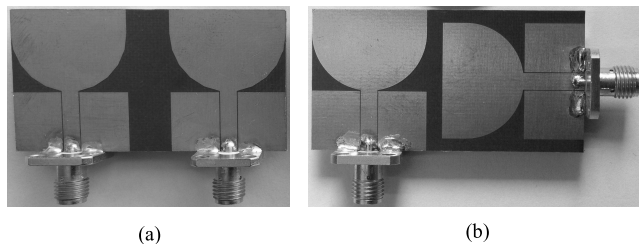

FIGURE 2. Photographs of UWB diversity antennas: (a) SP; (b) POL [18].

TABLE 1. Measurement setup information.

Measurement technique	Reverberation chamber
Measurement type	chamber calibration (e.g. REF antenna), reflection coefficient, total efficiency, diversity gain
Chamber loading	AUT with 50-Ω termination and REF antenna
REF antenna	BLUETEST discone REF antenna S/N: 001-C-005
Instrument used	Agilent E8363B, Agilent ECAL
Freq. range	3.0 GHz – 12 GHz (with steps of 6 MHz)
Freq. stirring	24 MHz
Stirring sequence	3 Stirrers - stepped sequence mode: 200 mechanical stirrer positions and 3 fixed antennas inside the chamber.
No. of diversity antennas	2
No. of samples per freq.	600
No. of freq. points	1501

IV. MEASUREMENT SETUP

Multiple-mode fields inside reverberation chambers can be expanded in terms of eight times more plane waves than excited modes [19]. It emulates a rich multipath propagation environment [20], and can be used to accurately measure both embedded radiation efficiencies [21] and DGs [22], [23]. The DGs can also easily be estimated from the embedded element efficiencies and correlation between ports using simple equations [24]. In this study, the whole measurements were conducted in the reverberation chamber at Chalmers University, with dimensions 1.9 m × 2.0 m × 1.4 m, one of the chambers characterized in [21]. The detailed measurement setup information is given in Table 1. Note that measurements to evaluate the DG have been carried out from 3 to 12 GHz; performance at higher frequencies was measured considering the limitation in the measurement equipment, e.g. the reference (REF) antenna. As seen in Table 1, the REF antenna is a standard discone antenna developed by BLUETEST [25]. It is well matched (based on $|S_{11}| \leq -10$ dB) from 0.7-9.5 GHz and its impedance up to 12 GHz is below -6 dB. The same setup was used for the calibrations. During the measurements, when one branch is connected to the network analyzer, the other branch is terminated with a 50-Ω load and vice versa. In order to obtain the DG, at first the power samples of the two branches of each diversity antennas are combined using the three common methods,

i.e. SC, EGC and MRC. Then, the CDF of each branch’s power and the combined power samples need to be evaluated. Finally, by estimating the average power level difference between the CDFs, at the certain cumulative probability level (normally 1%), of the combined case and the strongest branch the DG is obtained.

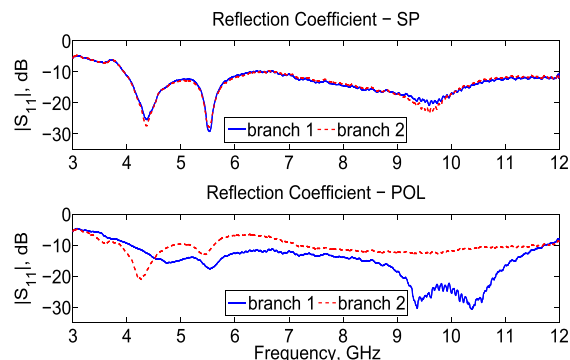

FIGURE 3. Measured antennas’ $|S_{11}|$ in reverberation chamber.

V. EXPERIMENTAL RESULTS AND DISCUSSION

Fig. 3 illustrates measured $|S_{11}|$ of both prototypes in the reverberation chamber demonstrating their ultra-wide matching bandwidth. For both antennas the $|S_{11}|$ was checked in an anechoic chamber as well; for the POL, looking at the results presented in [18] we note that the matching levels are very similar when measured in a reverberation chamber. The isolation between the two branches of the SP was also checked and found to be higher than 15 dB across the entire band of interest.

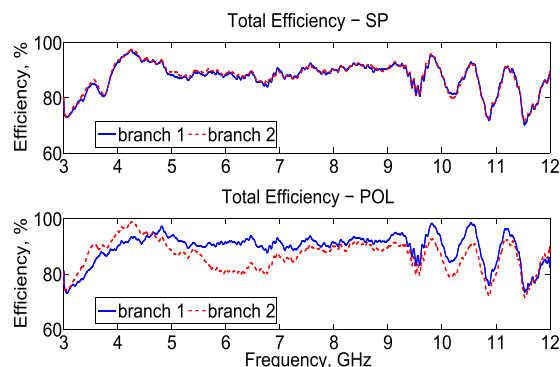

FIGURE 4. Measured antennas’ total efficiency in reverberation chamber.

In order to be able to compare the DG of both antennas, the effective DG must be calculated [8]. For this, total efficiency of both antennas is required. Fig. 4 depicts the measured total efficiency of the considered antennas. As observed, when both antennas are matched (4-12 GHz), an average total efficiency of almost 90% for SP and of about 80%-91% for POL is obtained for each of their branches. The fluctuations at higher frequencies 9.5-12 GHz is due to the matching issues of the used reference antenna, which has a similar behavior.

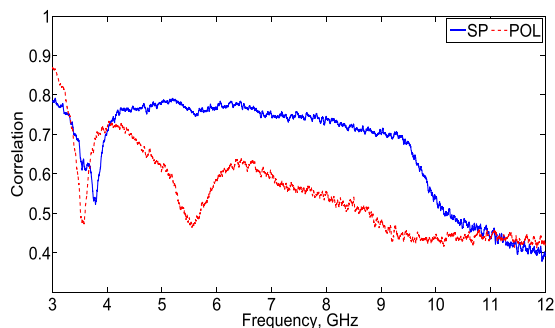

FIGURE 5. Measured correlation between antenna ports for both SP and POL.

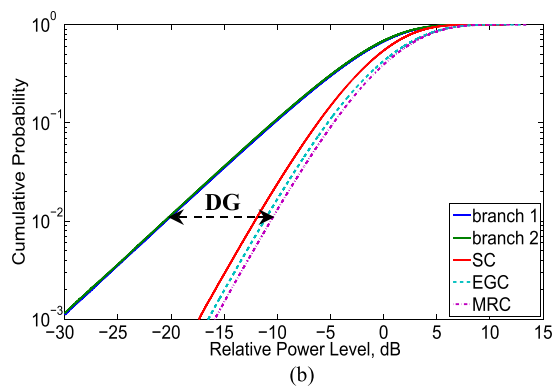
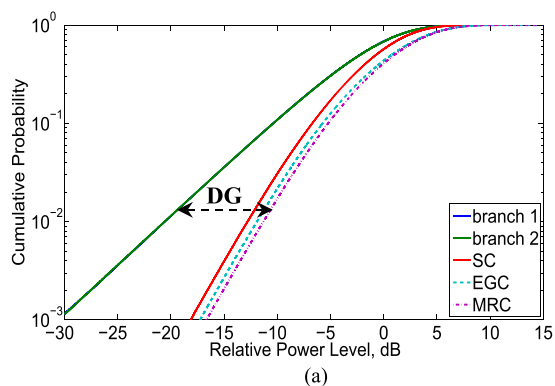

FIGURE 6. CDF plot, showing diversity gain at 1% outage probability, calculated from reverberation chamber measurement: (a) SP; (b) POL.

The apparent DG performance for SC, EGC and MRC in reverberation chamber is related to efficiency and correlation [26]. The correlation between antenna ports for SP and POL cases is plotted in Fig. 5. As seen, the correlation in the interval where the reference antenna is well matched is higher in the SP than the POL case which makes POL diversity perform better and provide improved DG results. To confirm this, the received power at each antenna's branches was combined through SC, EGC, and MRC techniques and the CDFs were calculated; Fig. 6 shows the results. As observed, by taking the power difference of the strongest branch, here both have similar power levels, and the combined case the DG is obtained. Fig. 7 illustrates both apparent and effective

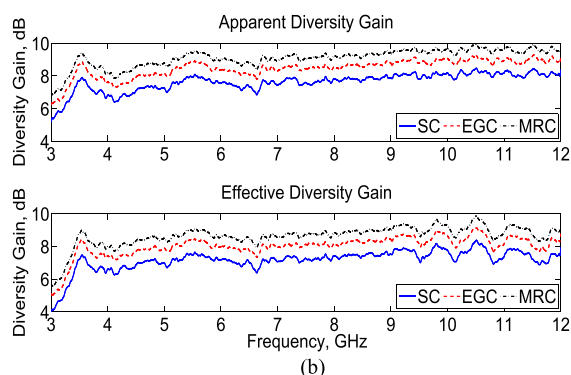
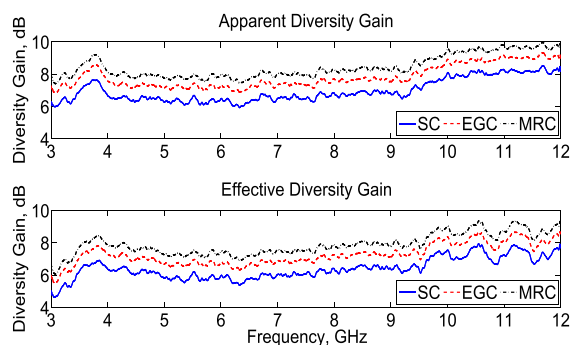

FIGURE 7. Measured apparent and effective diversity gains of the two antennas assuming 1% outage probability: (a) SP; (b) POL.

DGs of both antennas achieved with the considered combining techniques at outage probability of 1%. As seen, in all cases the DGs slightly improve with the increase of the frequency. The effective DG values, considering the frequency interval where both antennas have more stable efficiencies 4-9.5 GHz, for the SP/SC is about 6 dB whereas for the POL/SC it is about 7 dB. The MRC technique results in a higher effective DG for the both considered antennas; about 7.5 dB and 8.5 dB for SP and POL, respectively. This shows that both diversity antennas are suitable for UWB diversity applications, however, the POL leads to at least 1 dB (~ 26%) improvement in DG. The fluctuations appearing at the higher frequencies of the effective DG are due to the relation with the antenna's total efficiency. The repeatability of the measurements was checked, and similar results obtained.

VI. CONCLUSION

An experimental comparison of diversity gain between polarization and spatial diversity techniques in UWB systems has been made. In order to have a fair comparison, two different dual-port CPW-fed UWB diversity antennas having the same size and identical monopoles were taken as representative antennas. The diversity gain was measured in a reverberation chamber which provides characteristics similar to a multipath propagation environment. Three common diversity combining techniques

were considered. Results showed a diversity gain at 1% cumulative probability around 7.5 and 8.5 dB for SP/MRC and POL/MRC, respectively. Both antennas ensure good diversity behavior; however, the POL improves the diversity gain of about 1 dB.

ACKNOWLEDGMENT

The authors would like to thank Professor Per-Simon Kildal from Chalmers University for the fruitful discussions.

REFERENCES

- [1] C. B. Dietrich, Jr., K. Dietze, J. R. Nealy, and W. L. Stutzman, "Spatial, polarization, and pattern diversity for wireless handheld terminals," *IEEE Trans. Antennas Propag.*, vol. 49, no. 9, pp. 1271–1281, Sep. 2001.
- [2] A. Wang, Z. Feng, and K.-M. Luk, "Pattern and polarization diversity antenna with high isolation for portable wireless devices," *IEEE Antennas Wireless Propag. Lett.*, vol. 8, pp. 209–211, 2009.
- [3] I. Khan, P. S. Hall, A. A. Serra, A. R. Guraliuc, and P. Nepa, "Diversity performance analysis for on-body communication channels at 2.45 GHz," *IEEE Trans. Antennas Propag.*, vol. 57, no. 4, pp. 956–963, Apr. 2009.
- [4] I. Khan and P. S. Hall, "Multiple antenna reception at 5.8 and 10 GHz for body-centric wireless communication channels," *IEEE Trans. Antennas Propag.*, vol. 57, no. 1, pp. 248–255, Jan. 2009.
- [5] S. S. Ghassemzadeh, R. Jana, C. W. Rice, W. Turin, and V. Tarokh, "Measurement and modeling of an ultra-wide bandwidth indoor channel," *IEEE Trans. Commun.*, vol. 52, no. 10, pp. 1786–1796, Oct. 2004.
- [6] Q. H. Abbasi, M. M. Khan, S. Liaqat, M. Kamran, A. Alomainy, and Y. Hao, "Experimental investigation of ultra wideband diversity techniques for on-body radio communications," *Progr. Electromagn. Res. C*, vol. 34, pp. 165–181, 2013.
- [7] B. Lindmark and M. Nilsson, "Polarization diversity gain and base station antenna characteristics," in *Proc. IEEE Veh. Technol. Conf.*, vol. 1, Jul. 1999, pp. 590–595.
- [8] P.-S. Kildal, K. Rosengren, J. Byun, and J. Lee, "Definition of effective diversity gain and how to measure it in a reverberation chamber," *Microw. Opt. Technol. Lett.*, vol. 34, no. 1, pp. 56–59, 2002.
- [9] R. D'Errico, A. Sibille, A. Giorgetti, and M. Chiani, "Antenna diversity in UWB indoor channel," in *Proc. IEEE Int. Conf. Ultra-Wideband*, vol. 2, Sep. 2008, pp. 13–16.
- [10] G. Andrieux, J.-F. Diouris, and Y. Wang, "A comparison between spatial and polarisation diversity for transmit beamforming techniques," in *Proc. Eur. Conf. Wireless Technol.*, Oct. 2005, pp. 161–164.
- [11] Q. H. Abbasi, A. Alomainy, and Y. Hao, "Ultra wideband antenna diversity techniques for on/off-body radio channel characterisation," in *Proc. IEEE iWAT*, Mar. 2012, pp. 209–212.
- [12] W.-J. Chang, W.-J. Chang, J.-H. Tarnq, and S.-Y. Peng, "Frequency-space-polarization on UWB MIMO performance for body area network applications," *IEEE Antennas Wireless Propag. Lett.*, vol. 7, pp. 577–580, 2008.
- [13] V. Plicanic, "Antenna diversity studies and evaluation," M.S. thesis, Dept. Electrosci., Ericsson Mobile Communication AB, Lund, Sweden, 2004.
- [14] R. G. Vaughan and J. B. Andersen, "Antenna diversity in mobile communications," *IEEE Trans. Veh. Technol.*, vol. 36, no. 4, pp. 149–172, Nov. 1987.
- [15] A. M. D. Turkmani, A. Arowojolu, P. A. Jefford, and C. J. Kellett, "An experimental evaluation of the performance of two-branch space and polarization diversity schemes at 1800 MHz," *IEEE Trans. Veh. Technol.*, vol. 44, no. 2, pp. 318–326, May 1995.
- [16] L. C. Tran, T. A. Wysocki, A. Mertins, and J. Seberry, *Complex Orthogonal Space-Time Processing in Wireless Communications*, 1st ed. New York, NY, USA: Springer-Verlag, 2006.
- [17] H. Bölcskei, D. Gesbert, C. B. Papadias, and A.-J. van der Veen, Eds., *Space-Time Wireless Systems: From Array Processing to MIMO Communications*, 1st ed. Cambridge, U.K.: Cambridge Univ. Press, 2006.
- [18] M. Koohestani, A. A. Moreira, and A. K. Skriverik, "A novel compact CPW-fed polarization diversity ultrawideband antenna," *IEEE Antennas Wireless Propag. Lett.*, vol. 13, pp. 563–566, 2014.
- [19] K. Rosengren and P.-S. Kildal, "Study of distributions of modes and plane waves in reverberation chambers for the characterization of antennas in a multipath environment," *Microw. Opt. Technol. Lett.*, vol. 30, no. 6, pp. 386–391, 2001.
- [20] P.-S. Kildal and K. Rosengren, "Correlation and capacity of MIMO systems and mutual coupling, radiation efficiency, and diversity gain of their antennas: Simulations and measurements in a reverberation chamber," *IEEE Commun. Mag.*, vol. 42, no. 12, pp. 102–112, Dec. 2004.
- [21] P.-S. Kildal, X. Chen, C. Orlienius, M. Franzén, and C. S. L. Patané, "Characterization of reverberation chambers for OTA measurements of wireless devices: Physical formulations of channel matrix and new uncertainty formula," *IEEE Trans. Antennas Propag.*, vol. 60, no. 8, pp. 3875–3891, Aug. 2012.
- [22] X. Chen, P.-S. Kildal, J. Carlsson, and J. Yang, "MRC diversity and MIMO capacity evaluations of multi-port antennas using reverberation chamber and anechoic chamber," *IEEE Trans. Antennas Propag.*, vol. 61, no. 2, pp. 917–926, Feb. 2013.
- [23] X. Chen, P.-S. Kildal, and J. Carlsson, "Fast converging measurement of MRC diversity gain in reverberation chamber using covariance-eigenvalue approach," *IEICE Trans. Electron.*, vol. E94-C, no. 10, pp. 1657–1660, Oct. 2011.
- [24] N. Jamaly, P.-S. Kildal, and J. Carlsson, "Compact formulas for diversity gain of two-port antennas," *IEEE Antennas Wireless Propag. Lett.*, vol. 9, pp. 970–973, 2010.
- [25] *Blutest Wireless Test Solutions Through Innovative Application of the Reverberation Chamber Technology*. [Online]. Available: <http://www.blutest.se>
- [26] R. Waterhouse, Ed., *Printed Antennas for Wireless Communications*. New York, NY, USA: Wiley, 2008.



MOHSEN KOOHESTANI received the Ph.D. degree in electrical engineering from the École Polytechnique Fédérale de Lausanne and the Universidade de Lisboa, in 2014. He is currently a Post-Doctoral Fellow with the Institut d'Électronique et de Télécommunications de Rennes (IETR), Université de Rennes 1, where he is involved in wireless power transfer systems (WPTS). He has authored or co-authored over 30 peer-reviewed scientific journal and conference papers. His main field of research includes novel design and analysis of WPTS/antennas for wireless body-centric applications, design and characterization of human body models, dosimetry and exposure-level studies, and computational electromagnetic (time- and frequency-domain methods).



AHMED HUSSAIN was born in Karachi, Pakistan, in 1985. He received the B.S. degree in telecommunication engineering from the National University of Computer and Emerging Sciences, Pakistan, in 2007, the M.S. degree in radio and space science from the Chalmers University of Technology, Sweden, in 2008, and the Ph.D. degree in characterization of MIMO systems in multipath and line-of-sight from the Chalmers University of Technology, in 2014. He is currently with The MathWorks Inc., as a Technical Specialist. His current research interests include characterizing multipoint terminals in multipath environments, multiple-input, multiple-output systems, and software defined radios.



ANTONIO A. MOREIRA received the Ph.D. degree in electrical and computer engineering from IST/TUL, in 1984. He has participated in the RACE Projects, such as Multigigabit Transmission in the Subscriber Loop and Microwave Optical Transmission Antenna Link, and the IST projects, such as Antenna Center of Excellence, Flexible Convergence of Wireless Standards and Services, and Network of Excellence in Wireless Communications ++ (EU-FP7 ICT 2007–2010). He is currently an Associate Professor of Antennas and Radar with IST/TUL. He is a member of the Instituto de Telecomunicações (IT), where he performs his research activity with the IT Wireless Group. He has authored or co-authored about 70 publications, chapters in books, and papers presented at international conferences. His current interest focused on antennas for mobile communications. He is an active member of the EurAAP Working Group on Small Antennas. He was the General Chair of the IEEE International Workshop on Antenna Technology in IST/Lisbon in 2010.



ANJA K. SKRIVERVIK received the Electrical Engineering and Ph.D. degrees from the École Polytechnique Fédérale de Lausanne (EPFL), in 1986 and 1992, respectively. After a stay with the University of Rennes as an invited Research Fellow and after two years with the industry, she returned part time to EPFL as an Assistant Professor in 1996, where she is currently a Professeur Titulaire. Her teaching activities include microwaves and antennas. She has authored or co-authored over 150 scientific publications. Her research activities include electrically small antennas, implantable and wearable antennas, multifrequency and ultrawideband antennas, numerical techniques for electromagnetics, and microwave- and millimeter-wave microelectromechanical systems. She received the Latsis Award from EPFL.

She is very active in European collaboration and European projects. She was the Chairperson of the Swiss URSI until 2012, and a Board Member of the European School of Antennas. She is frequently requested to review research programs and centers in Europe.

• • •