

I

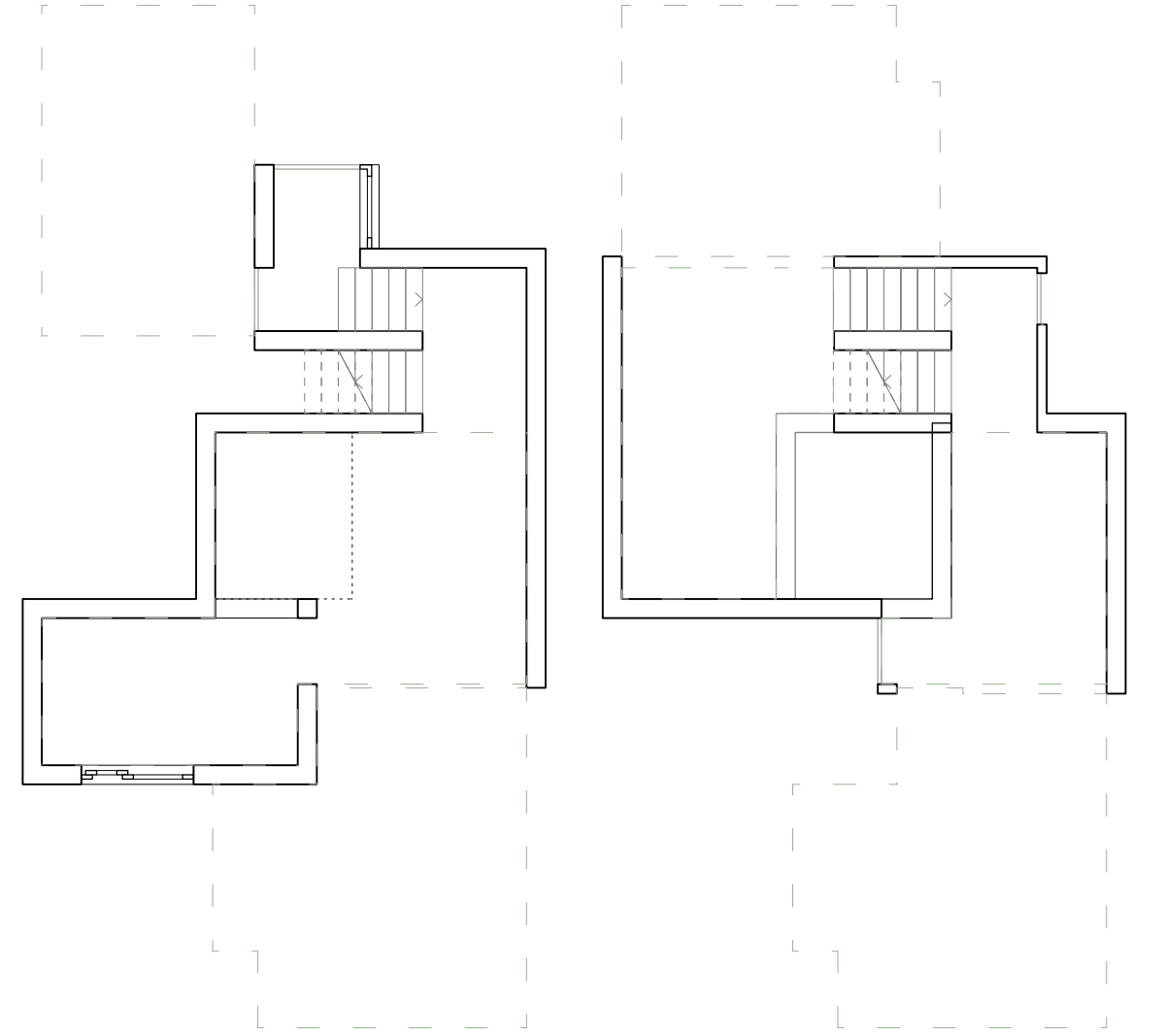

A

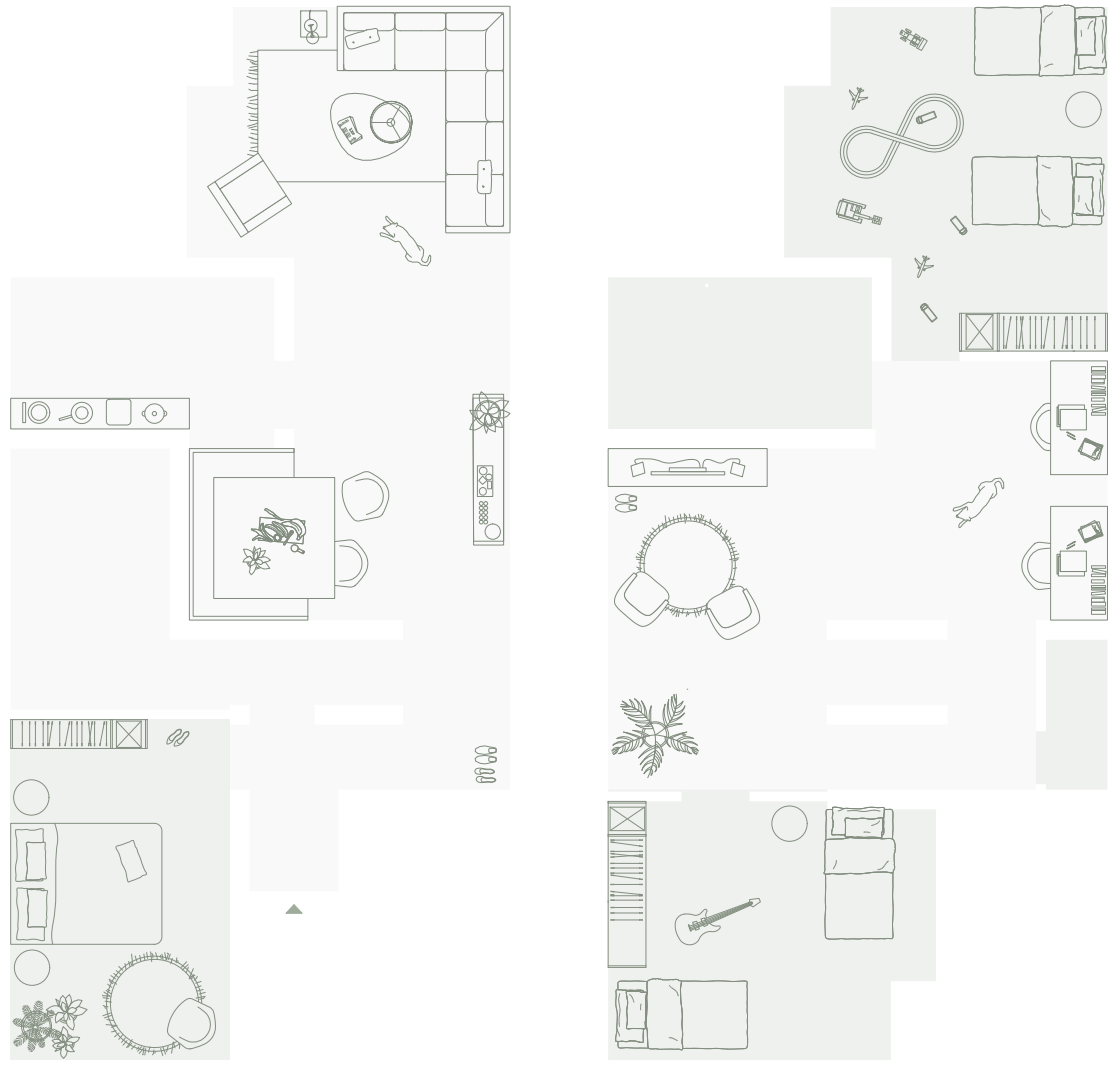
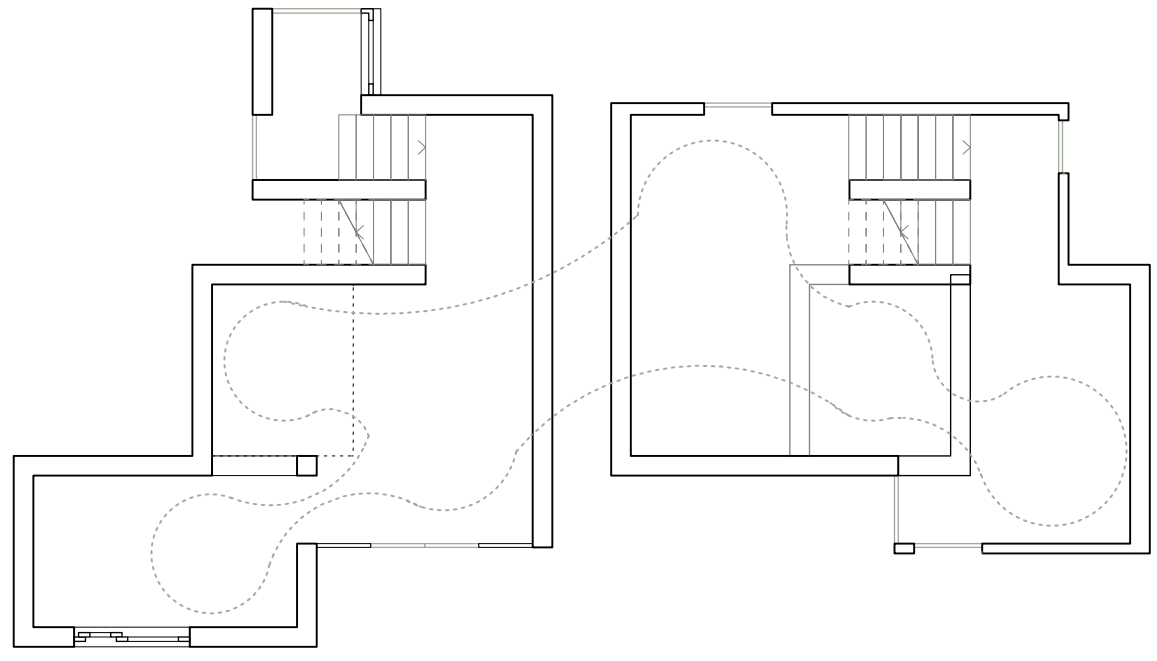
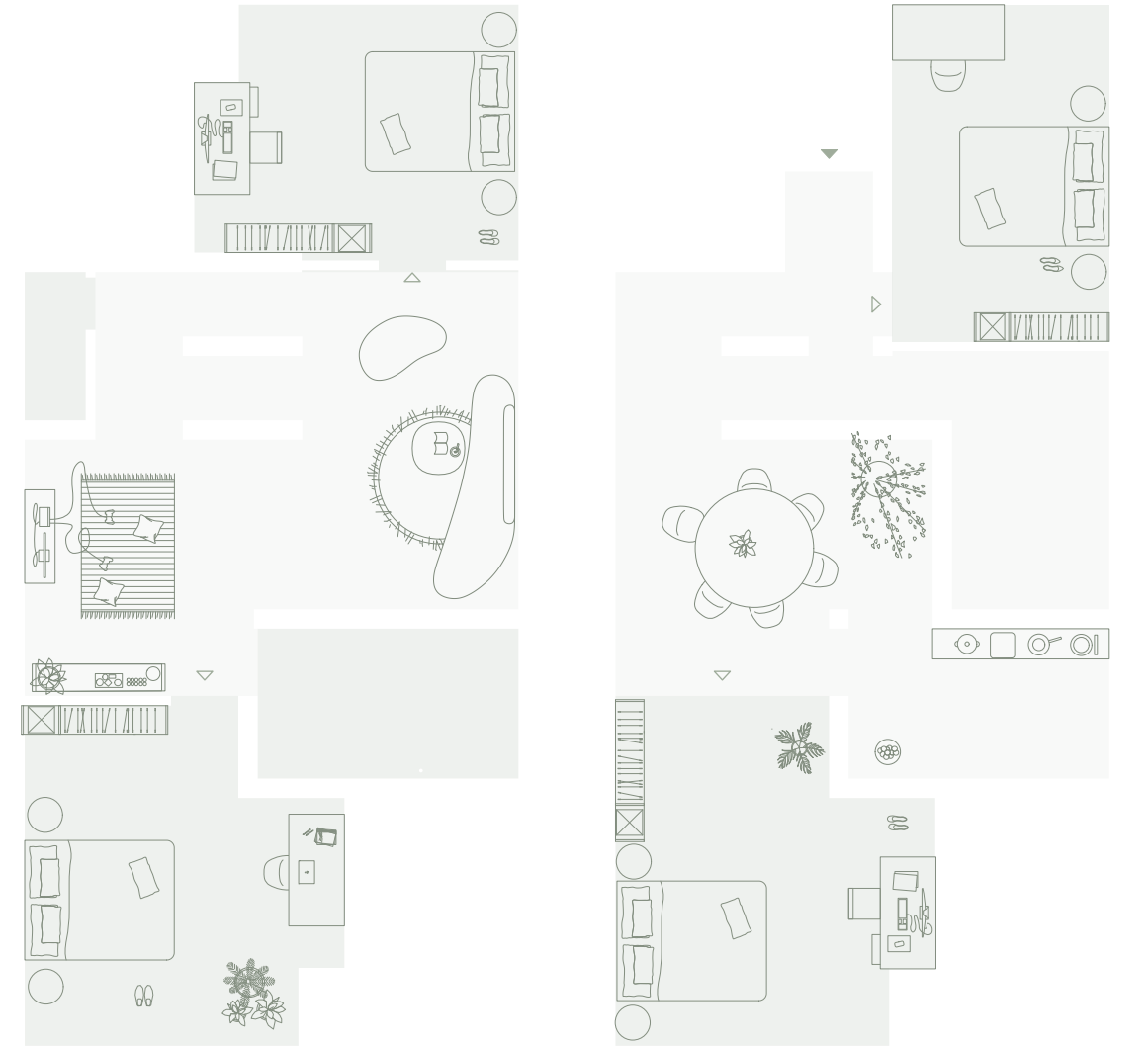
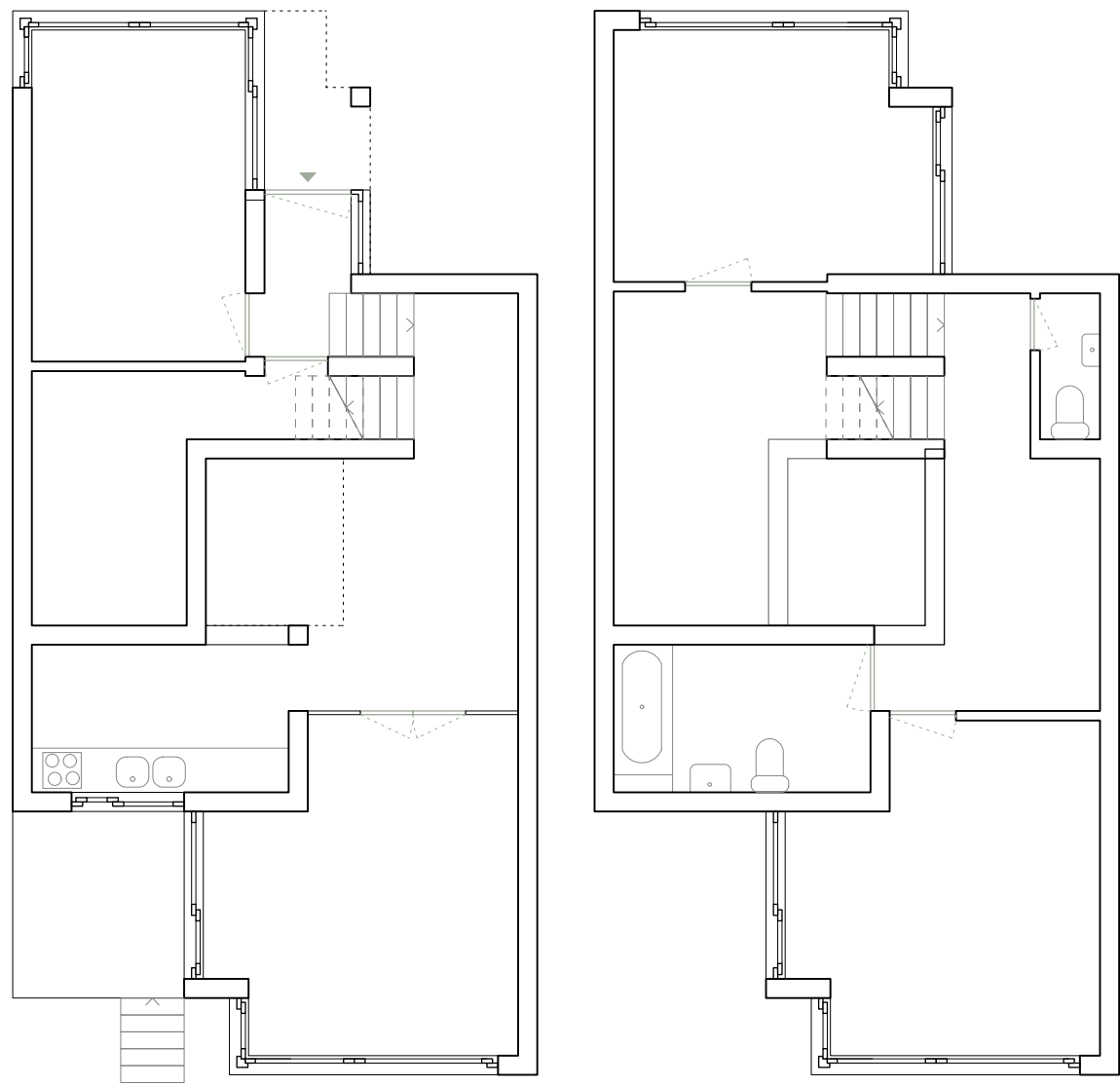
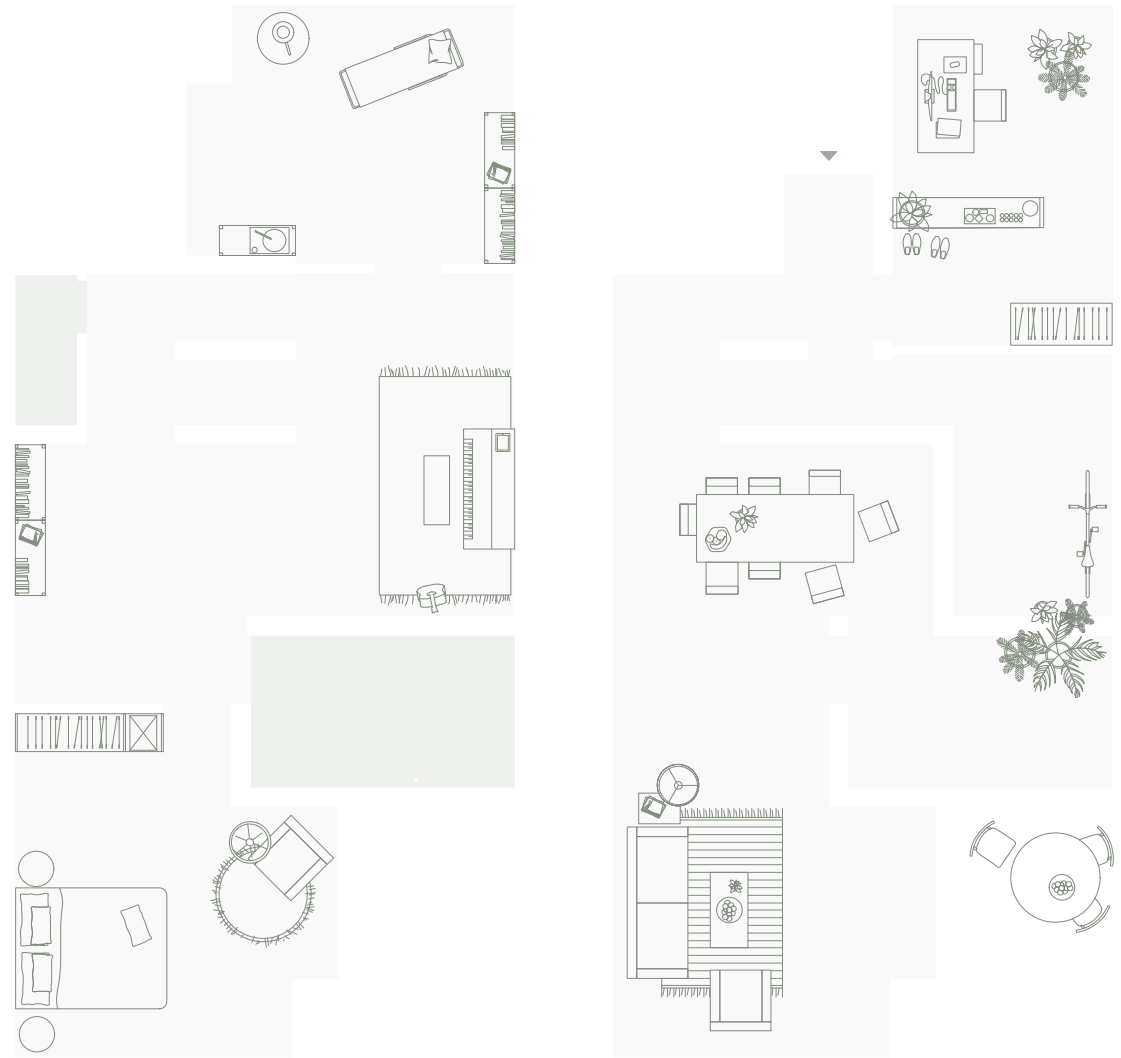

P

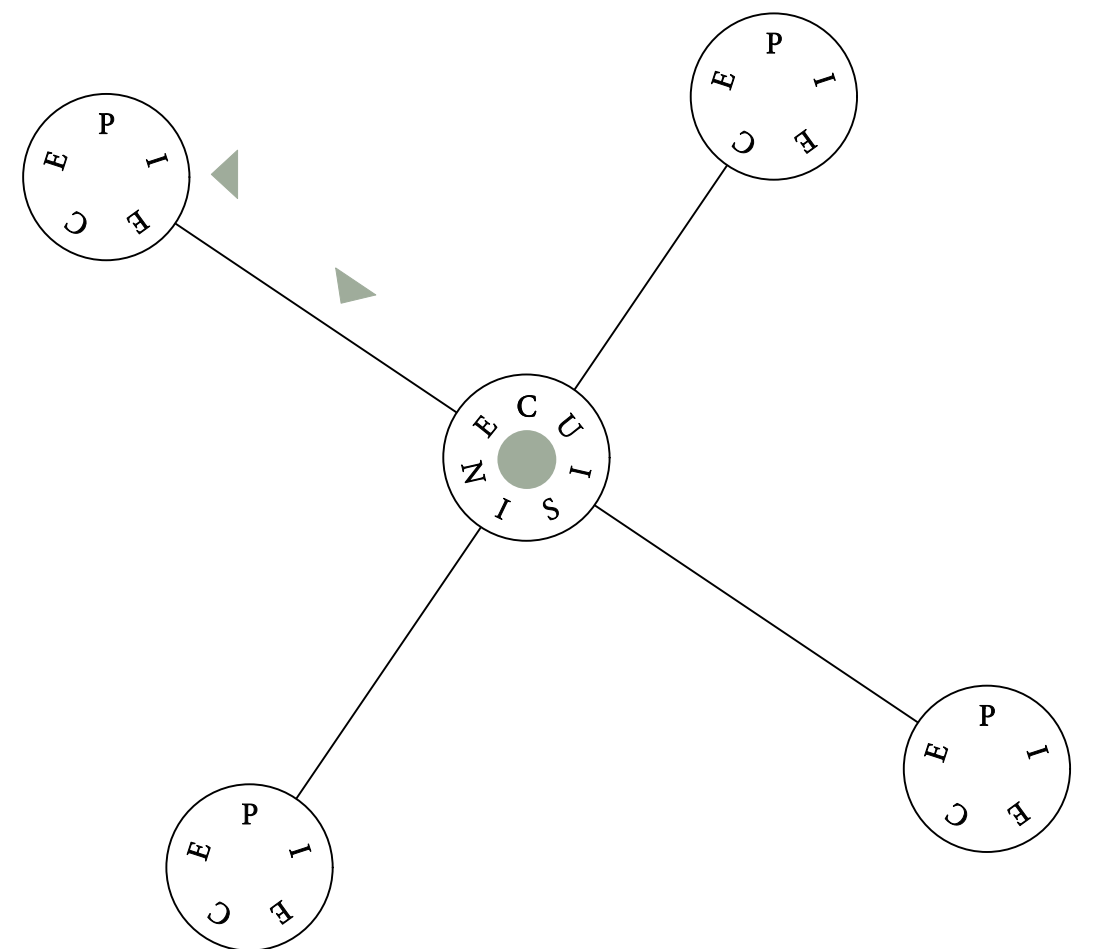
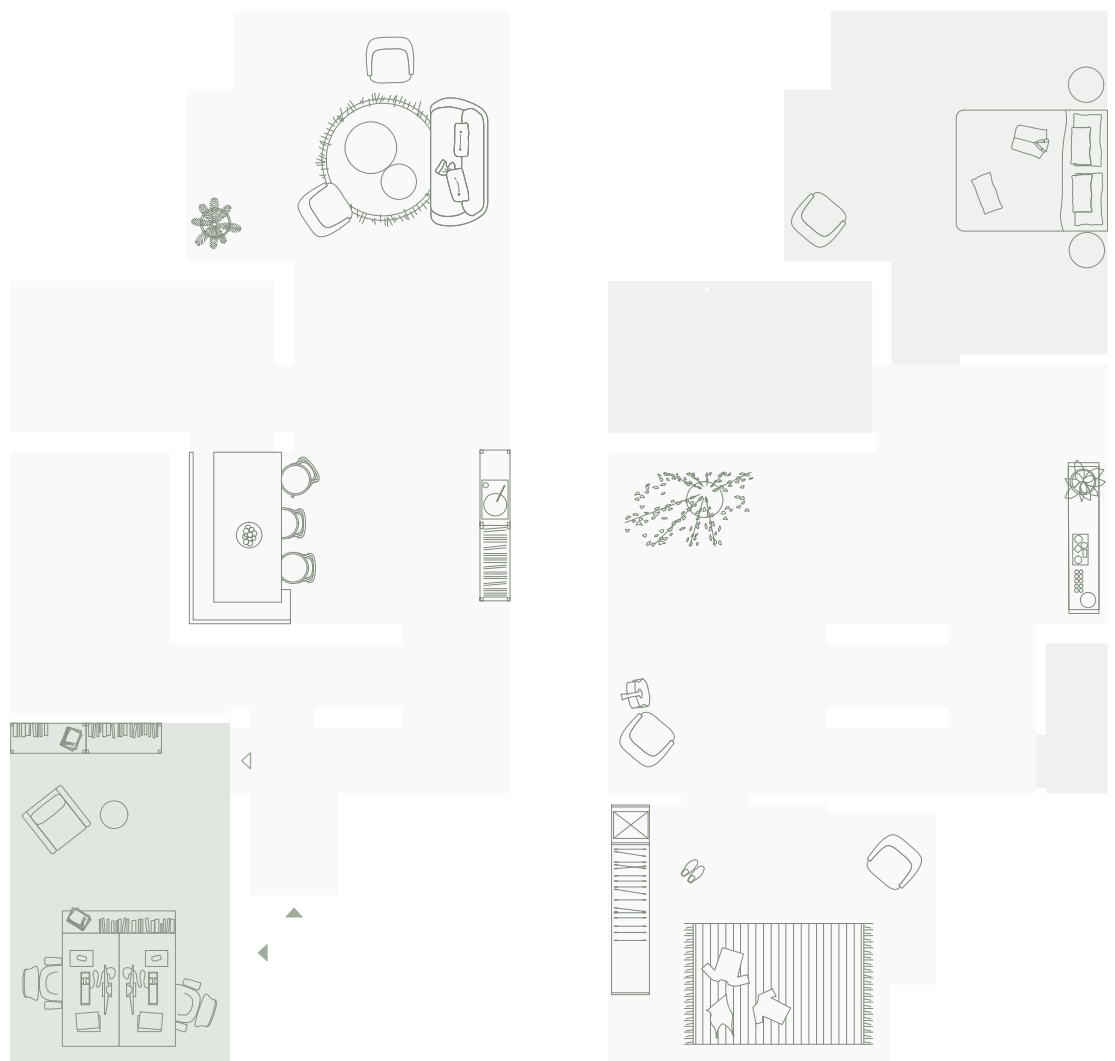
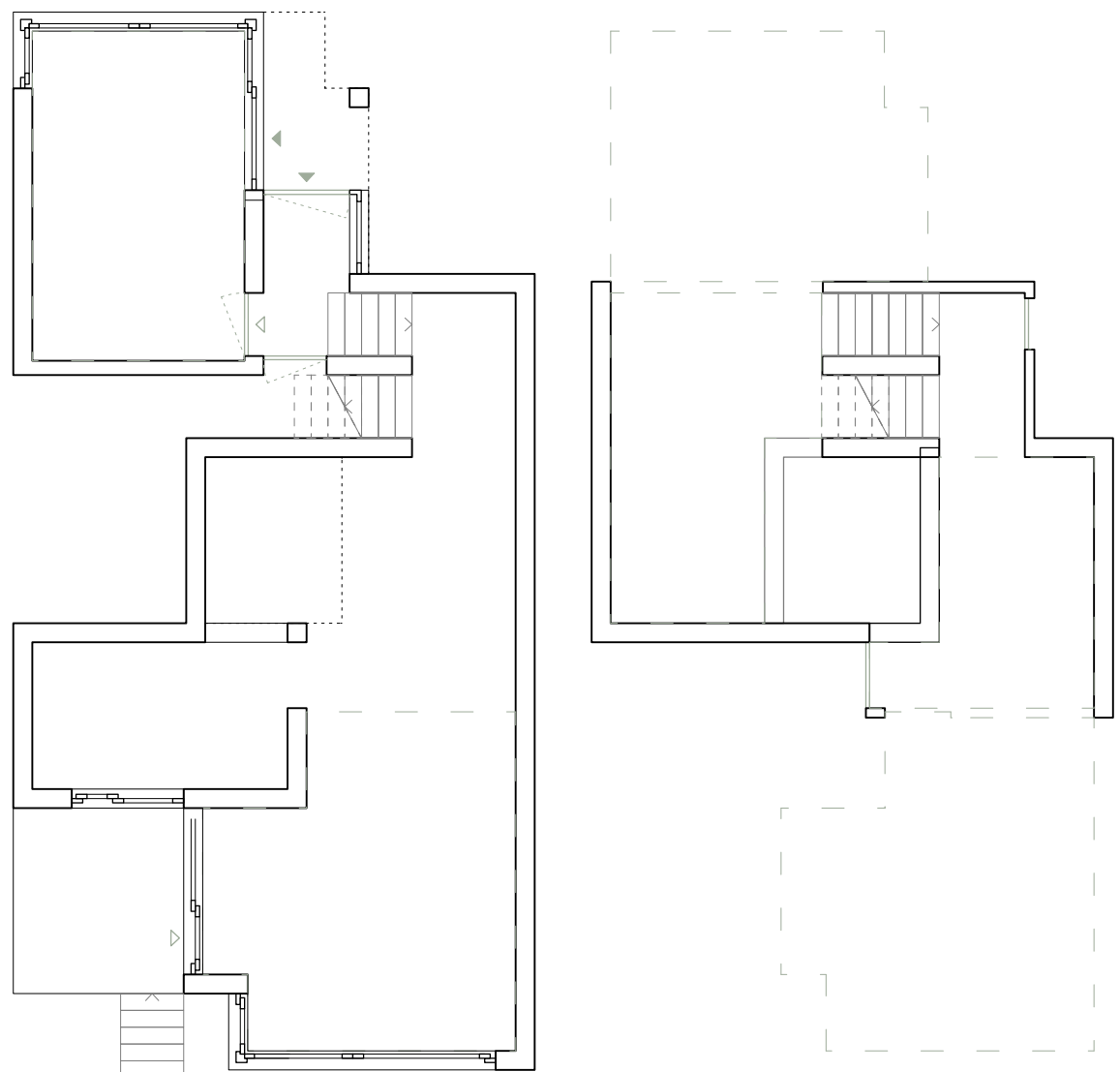

S

P

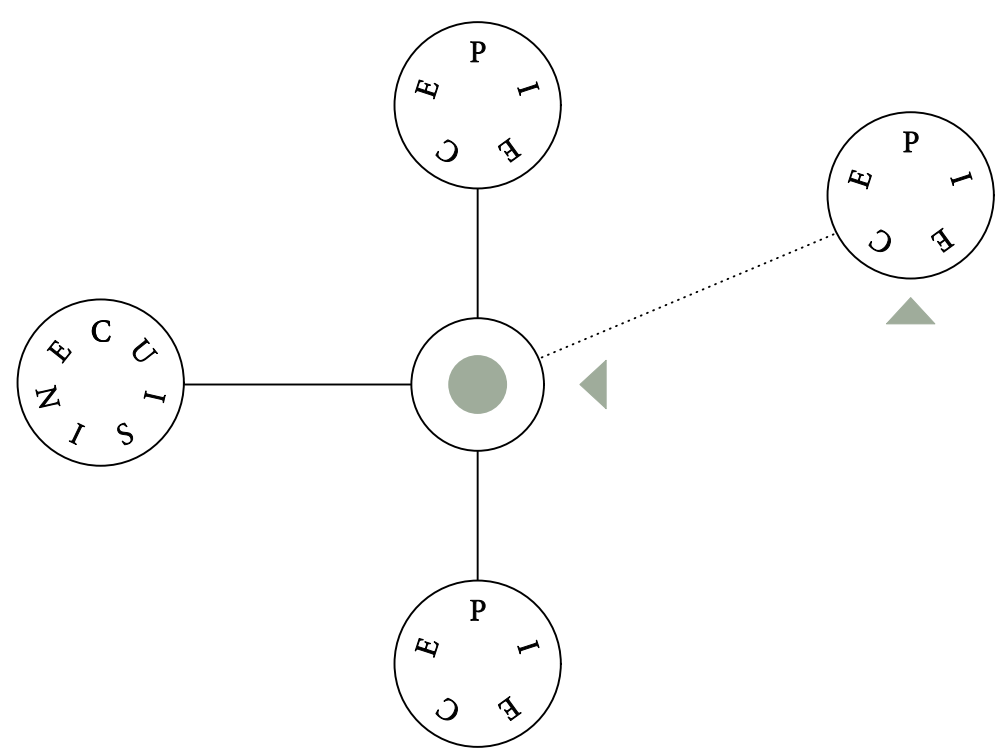
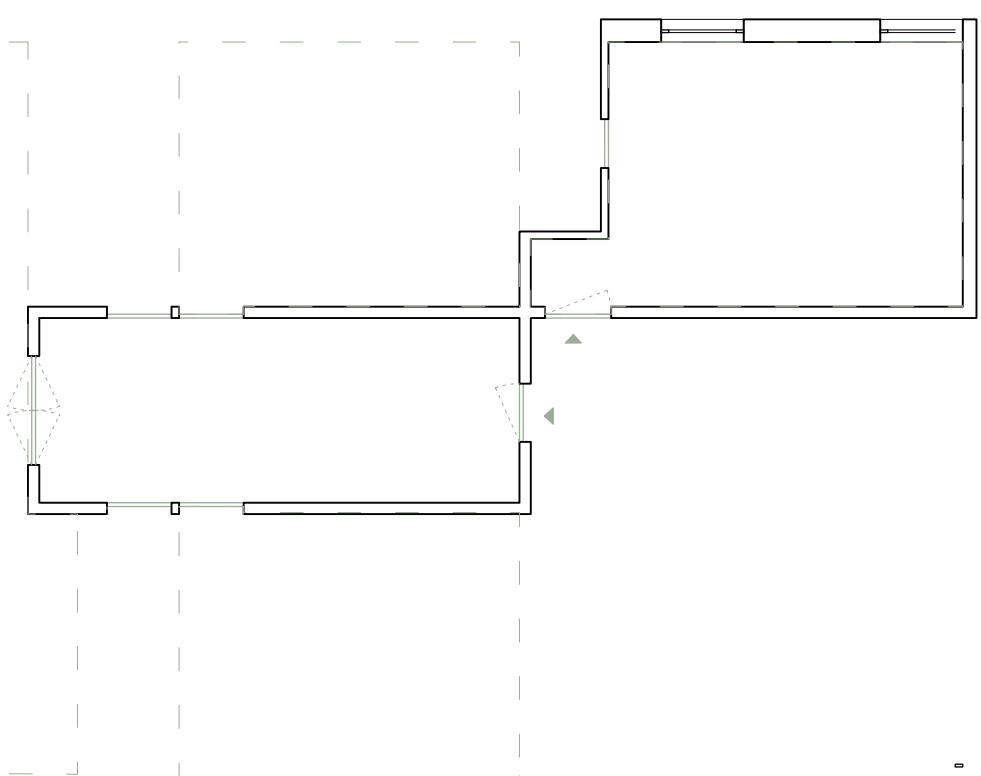
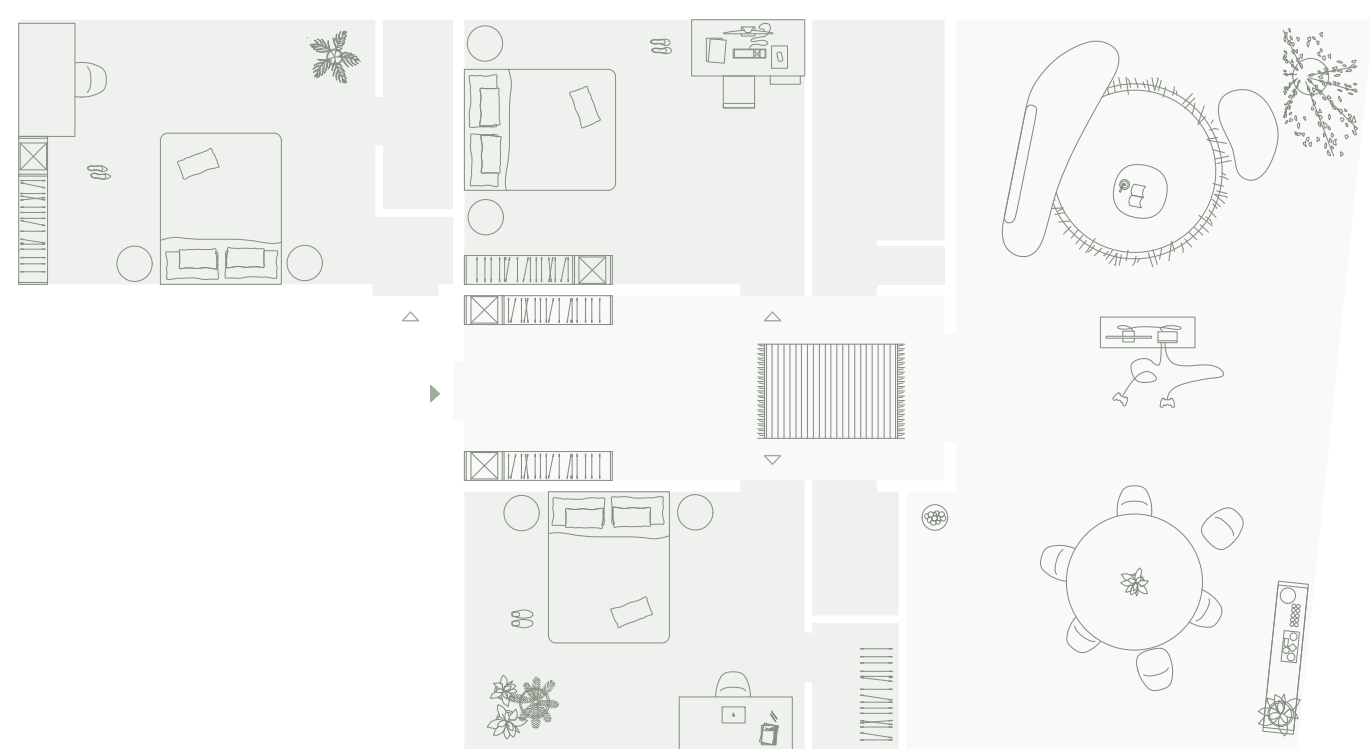
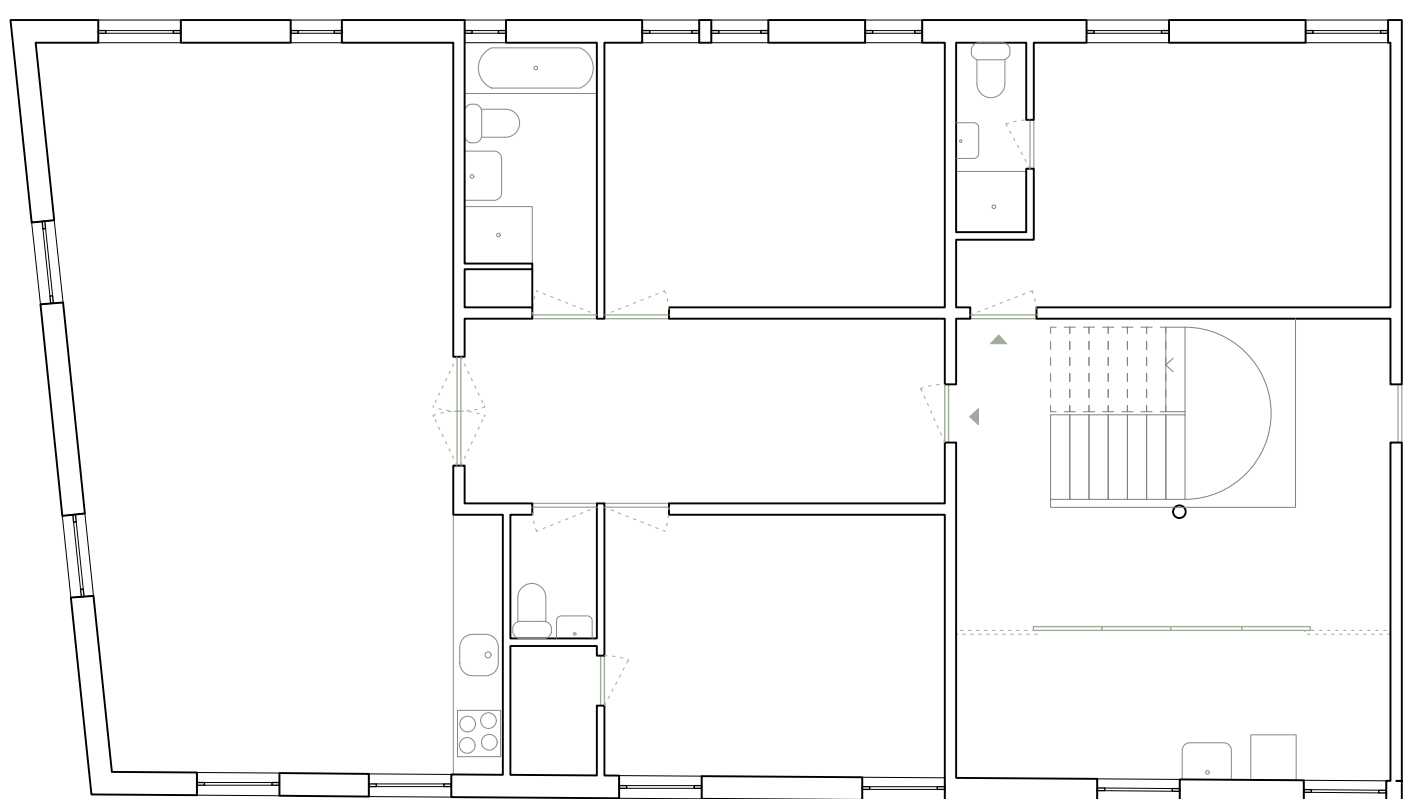
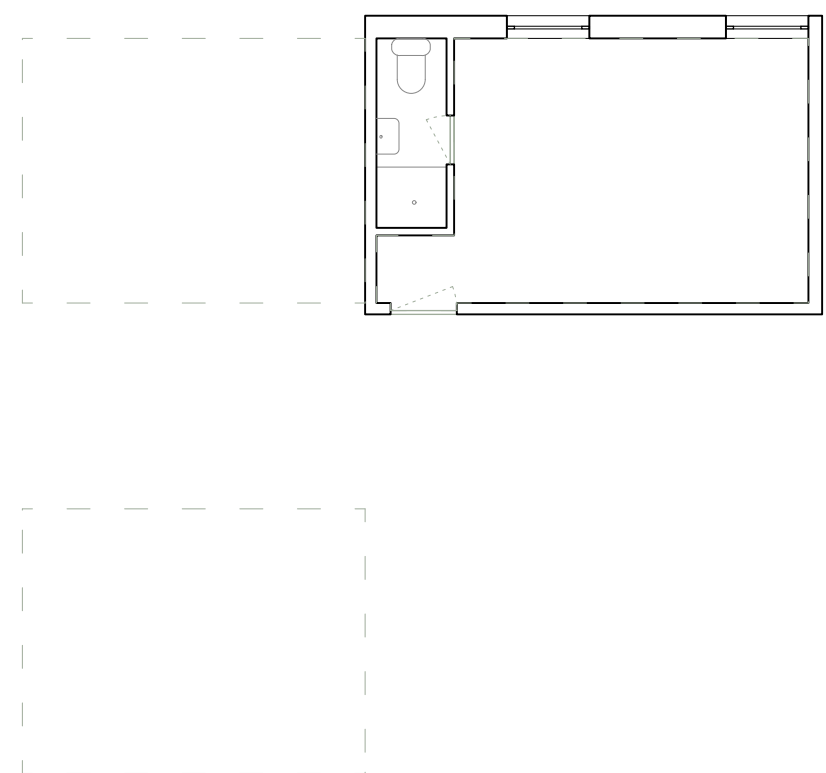
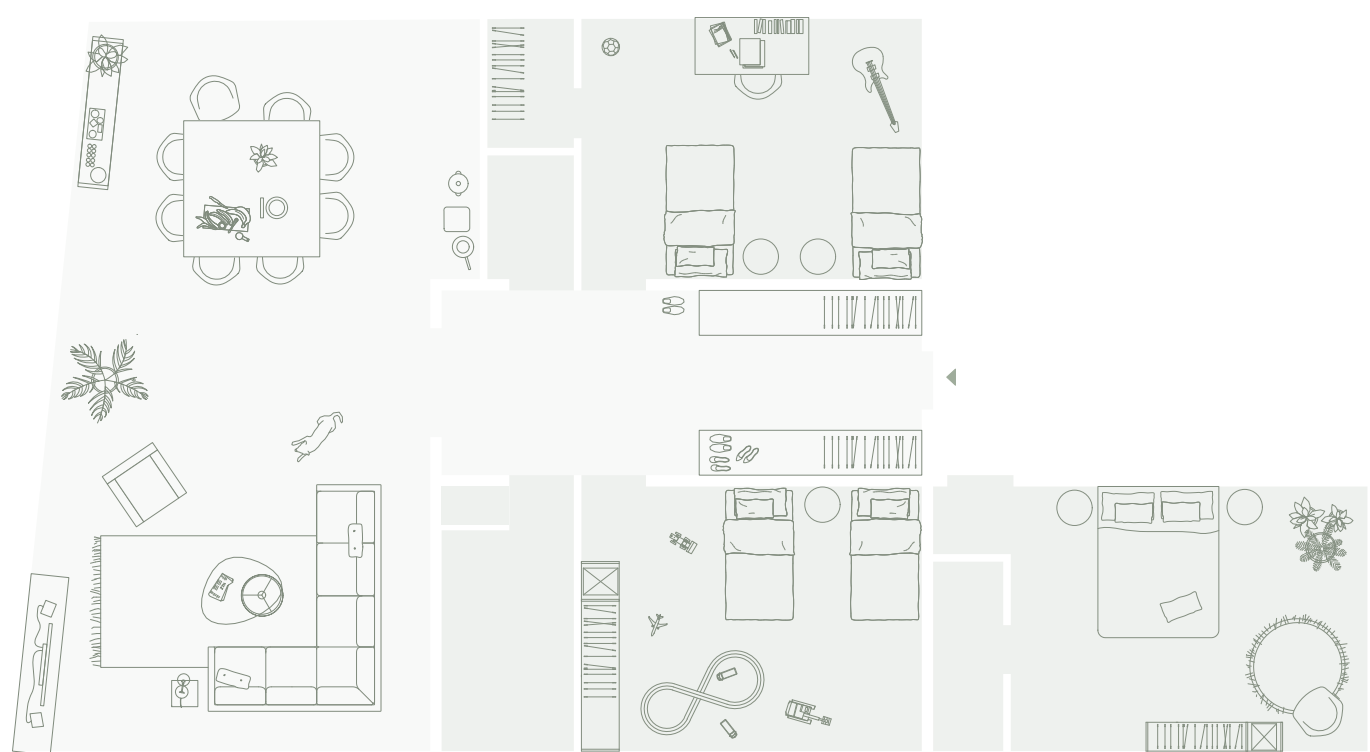
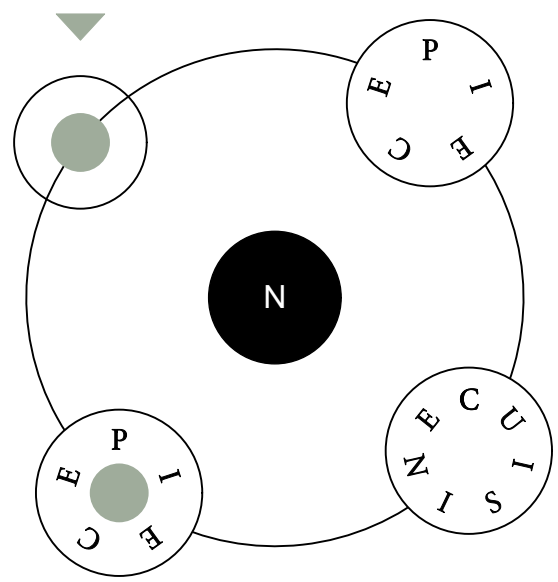

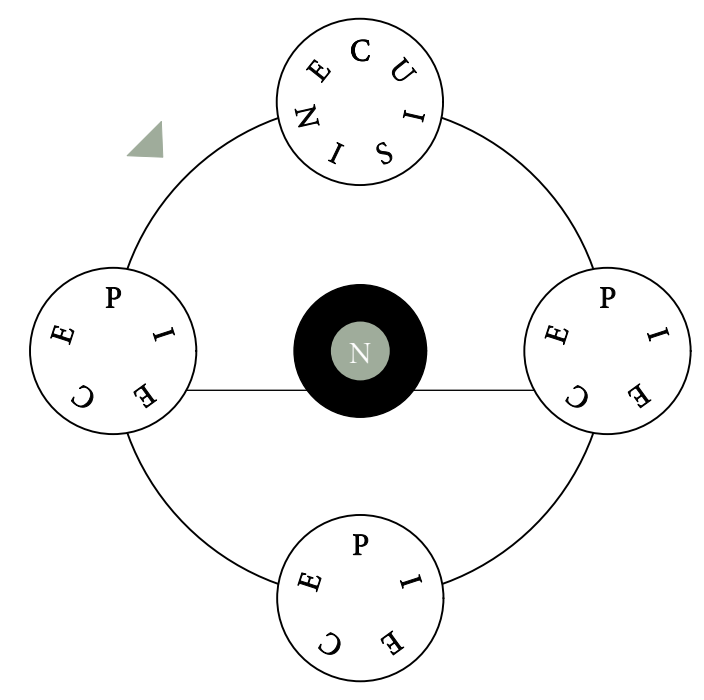
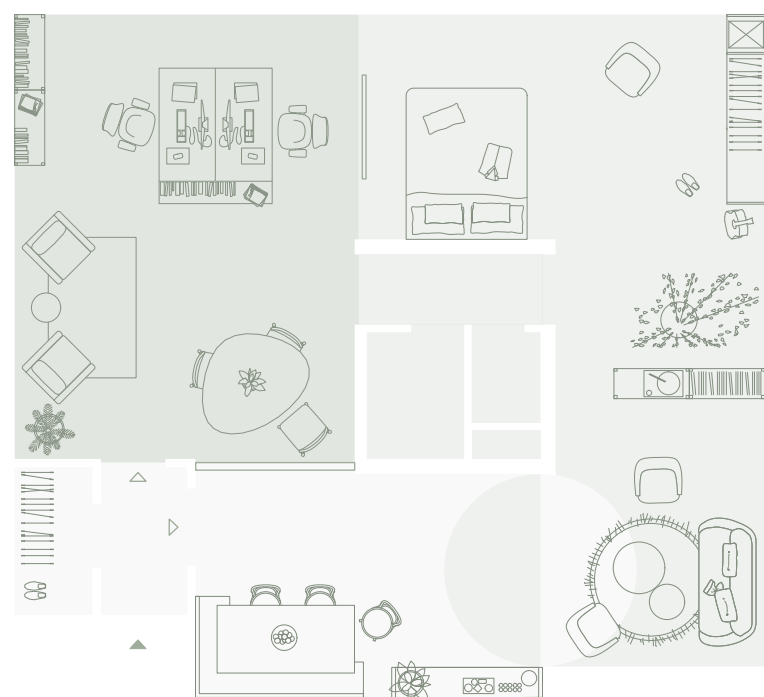
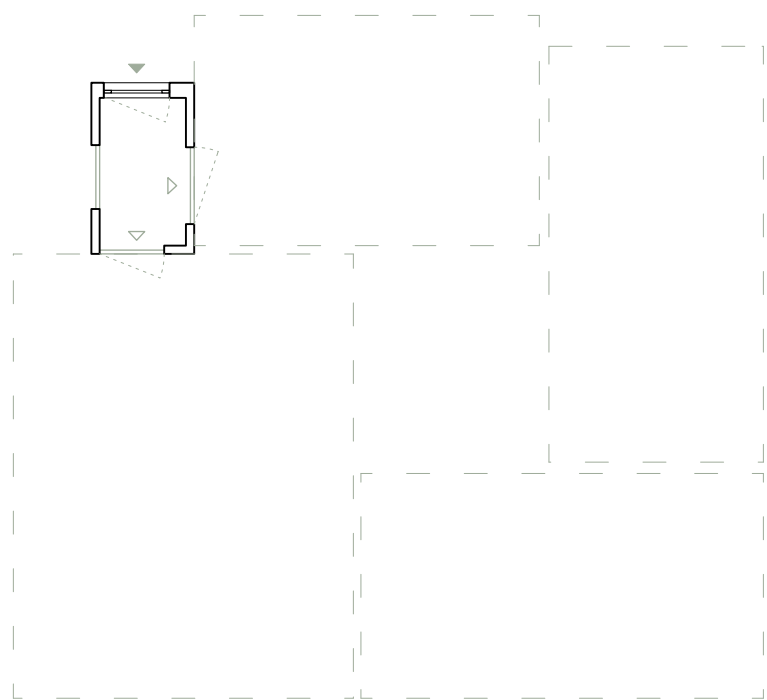
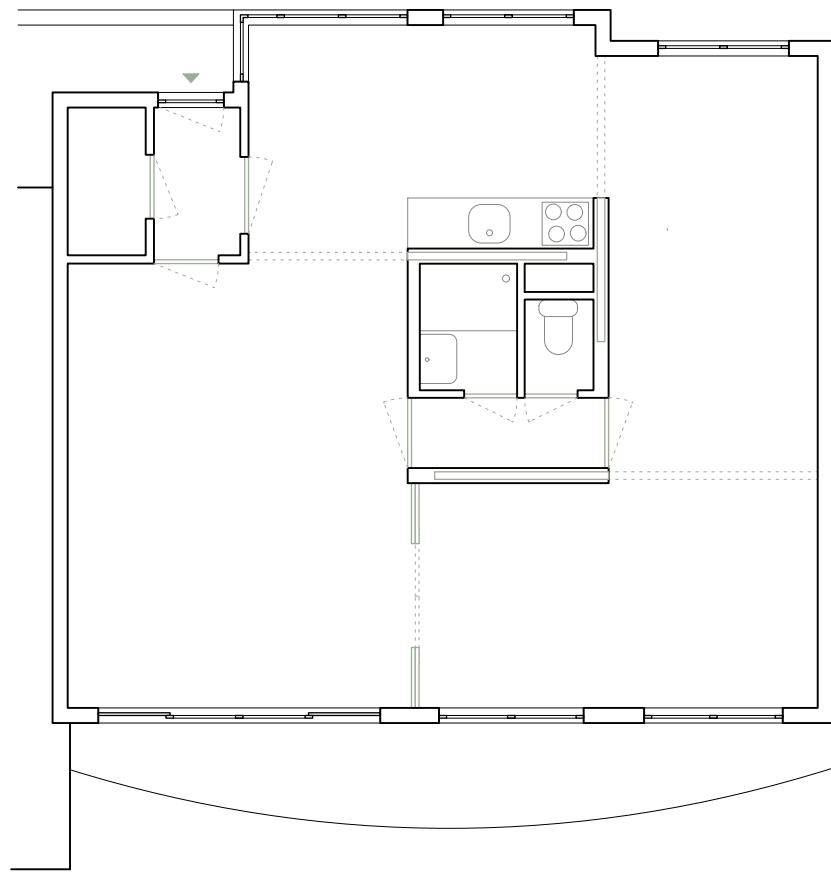
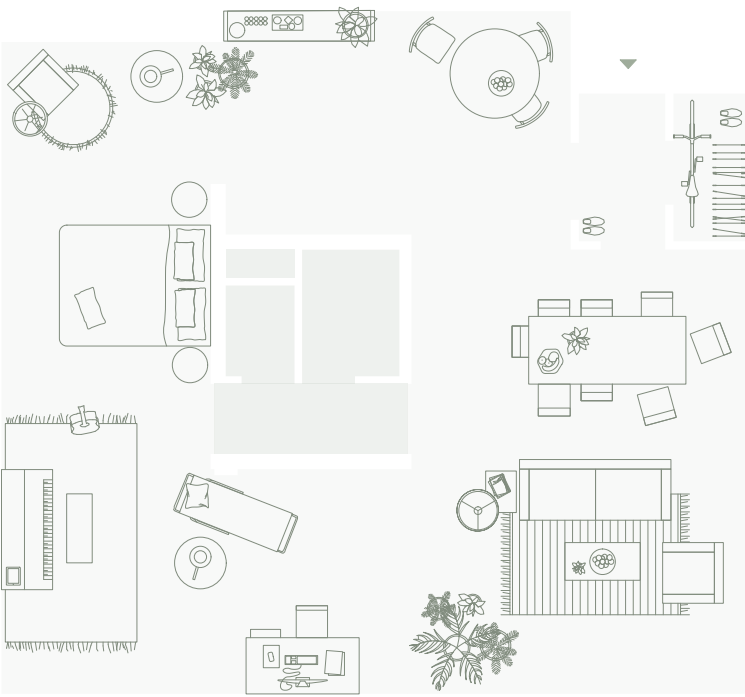
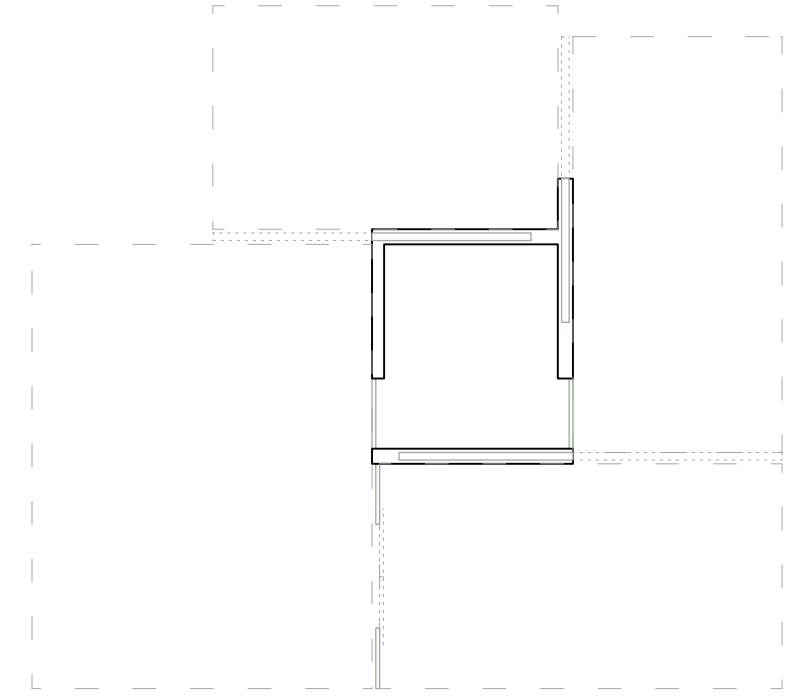
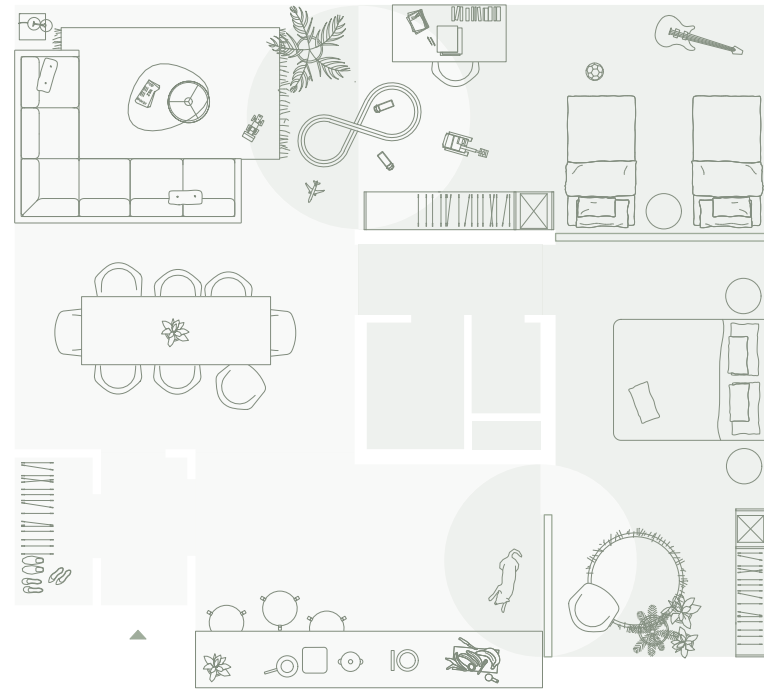
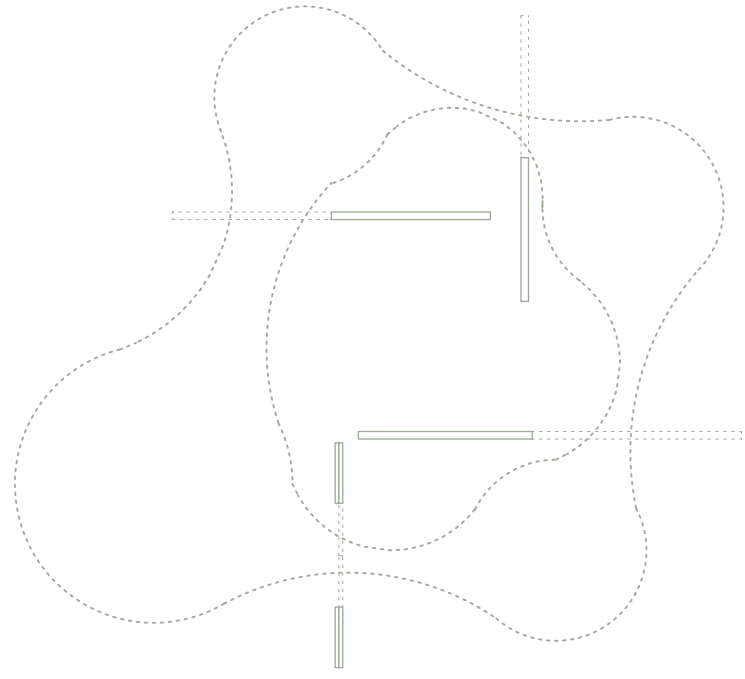

I

A

P

S

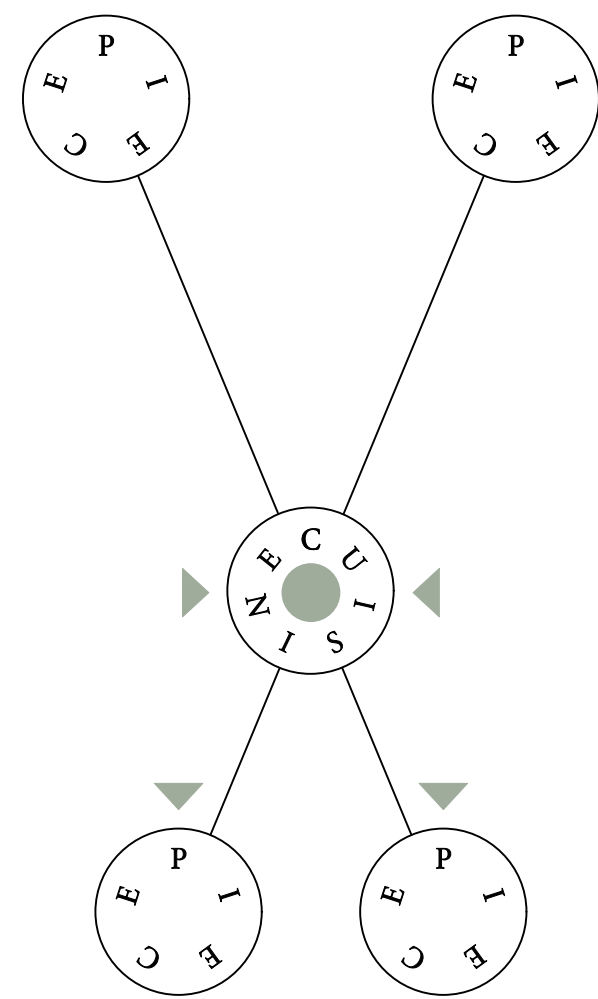
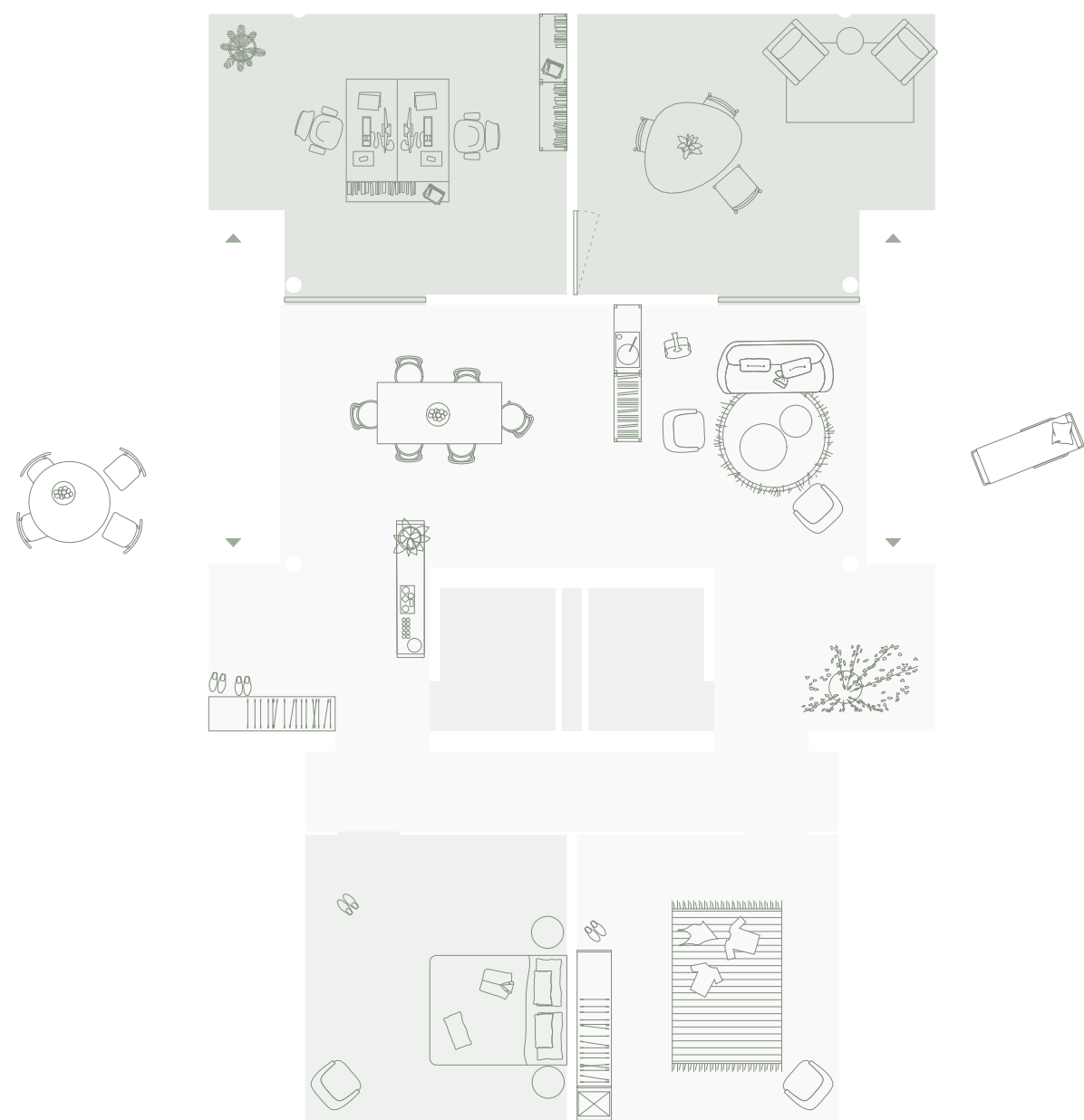
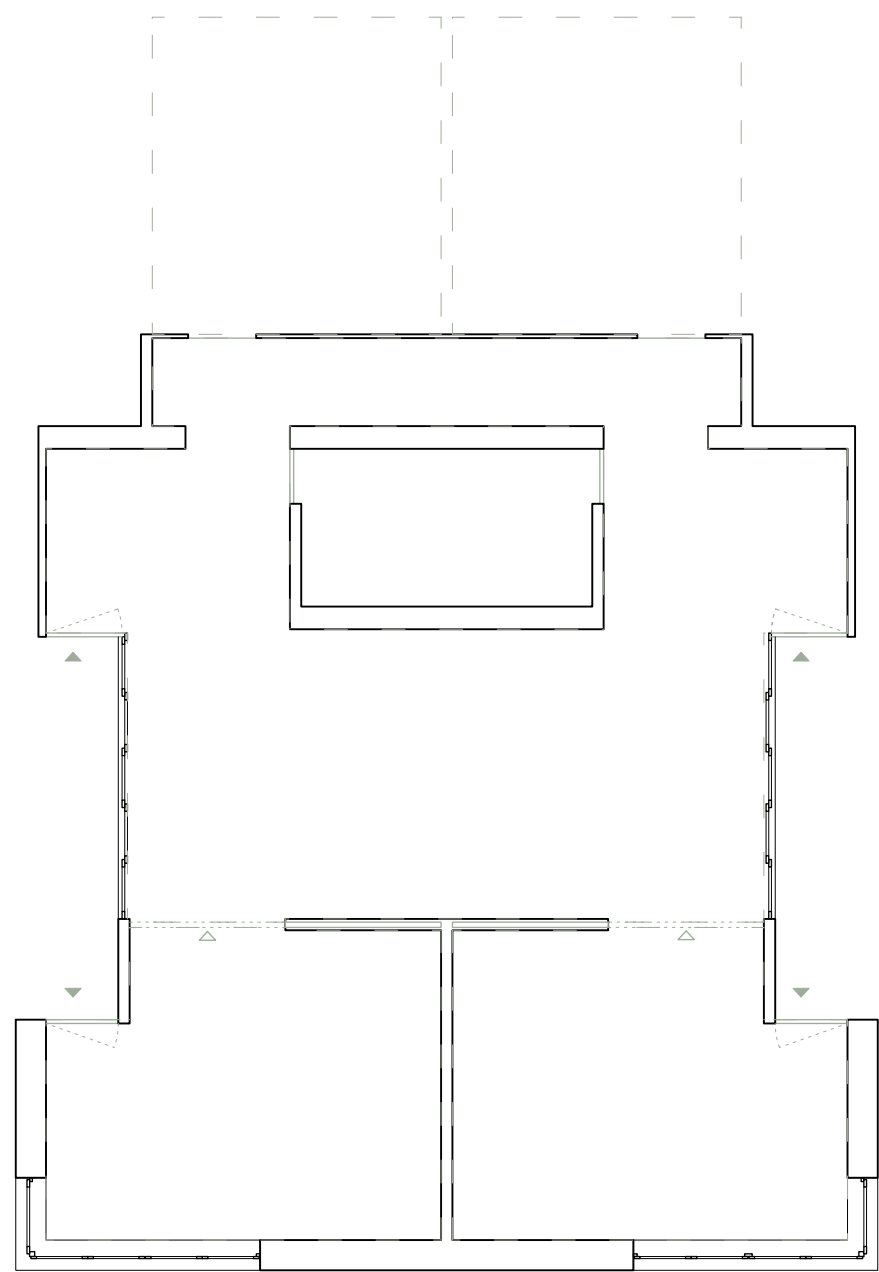
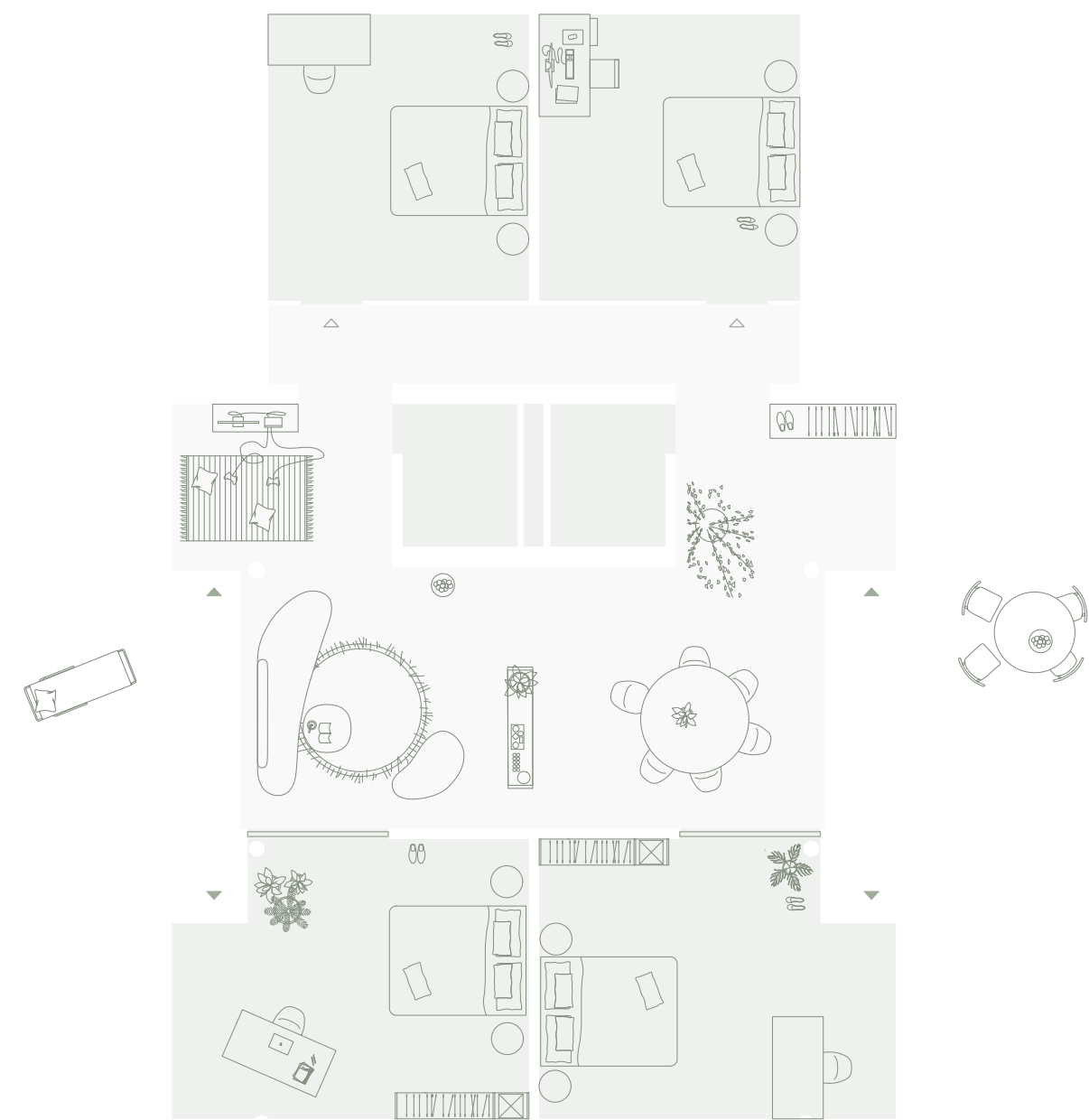
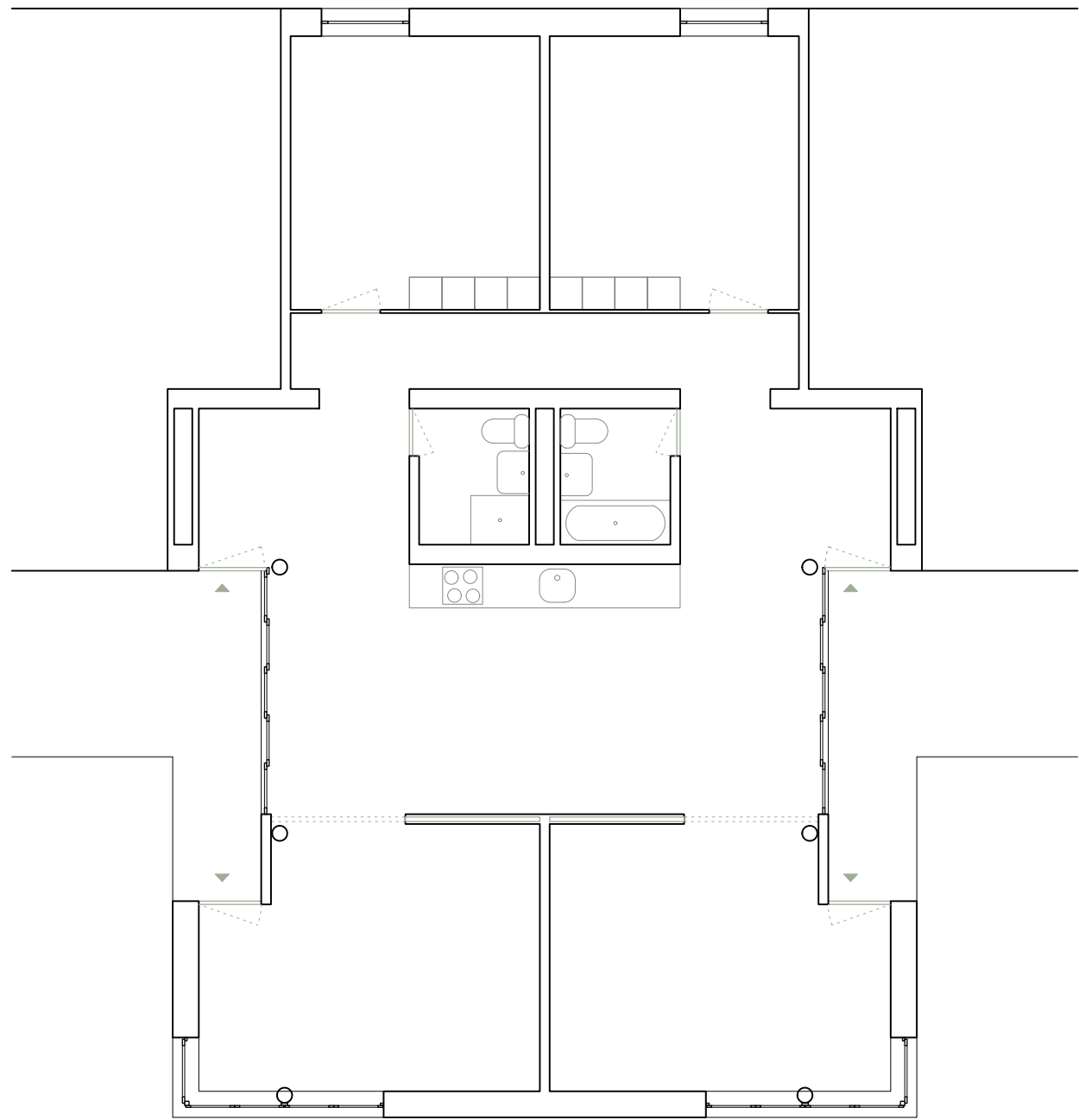
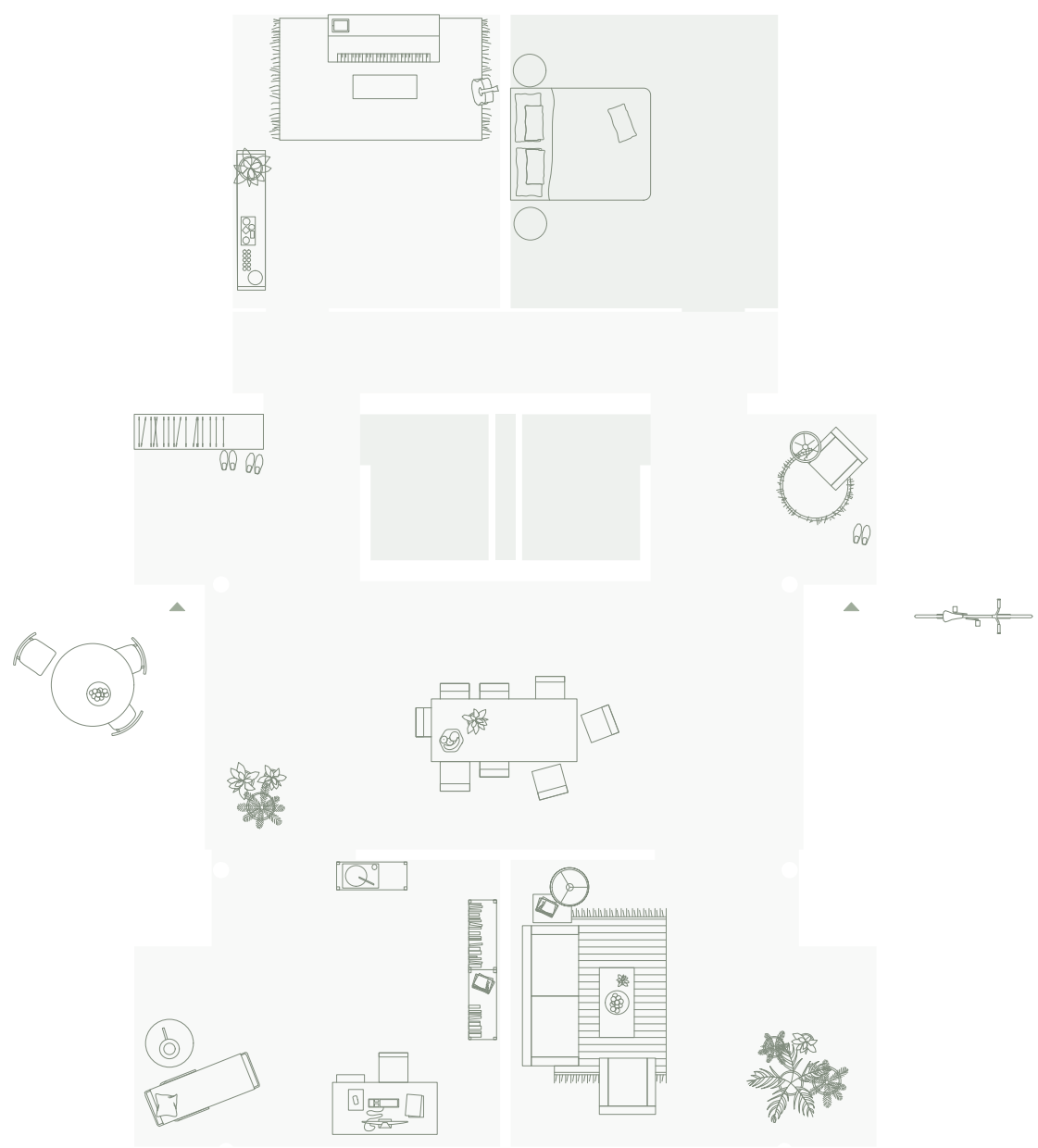
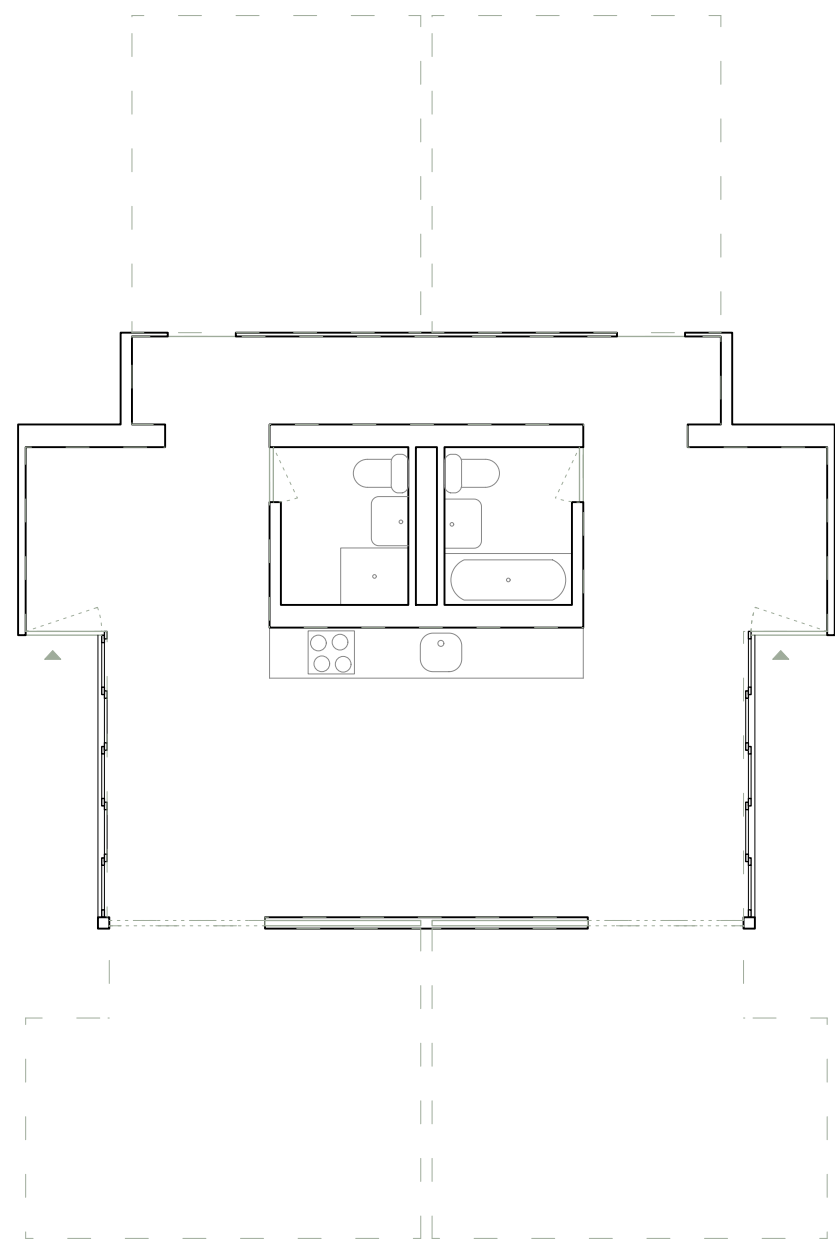
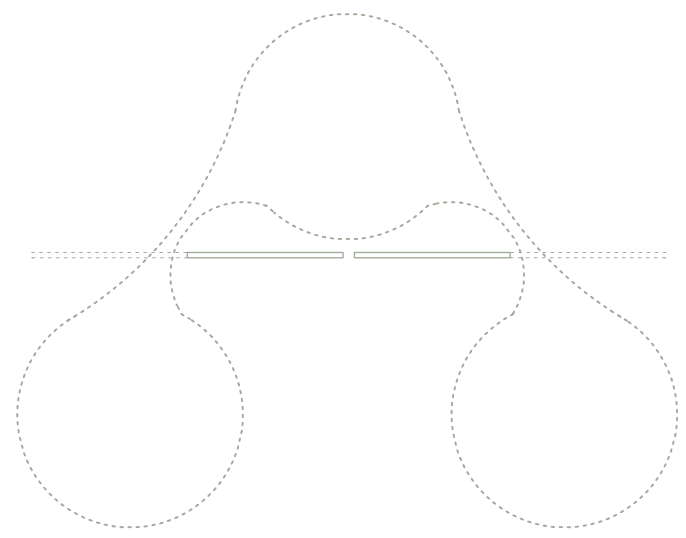

I

A

P

S



I

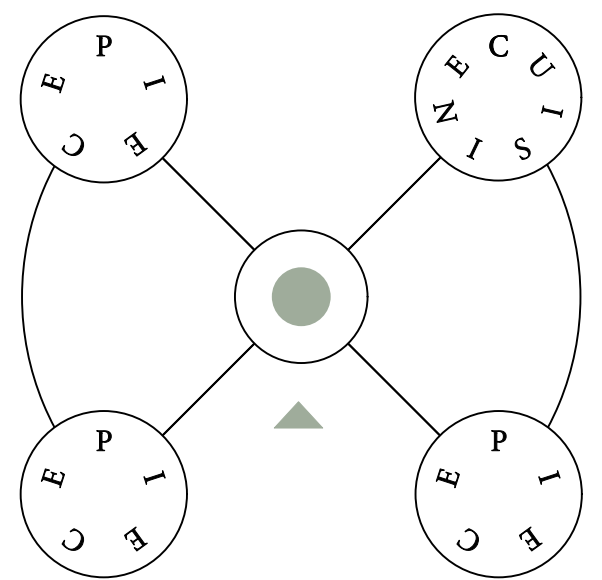
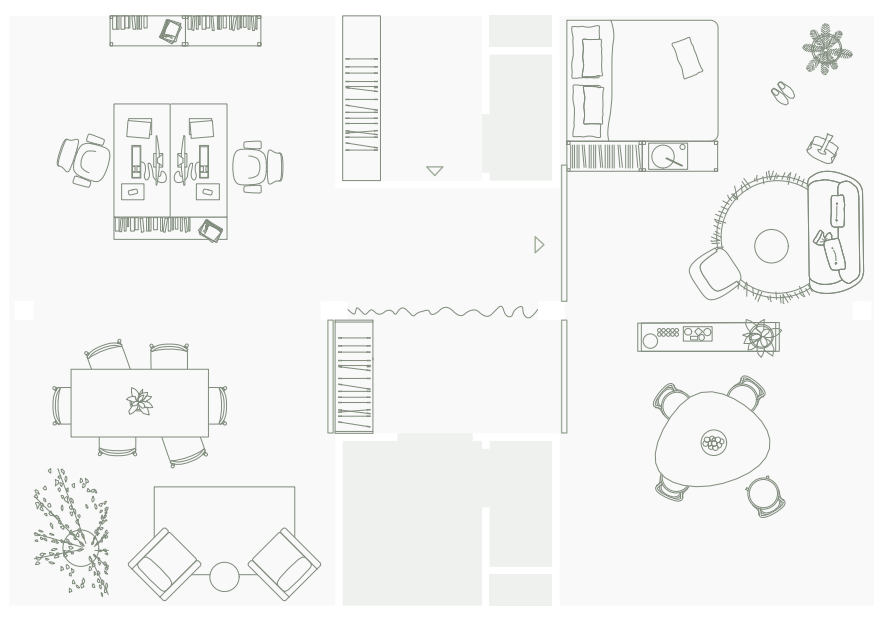
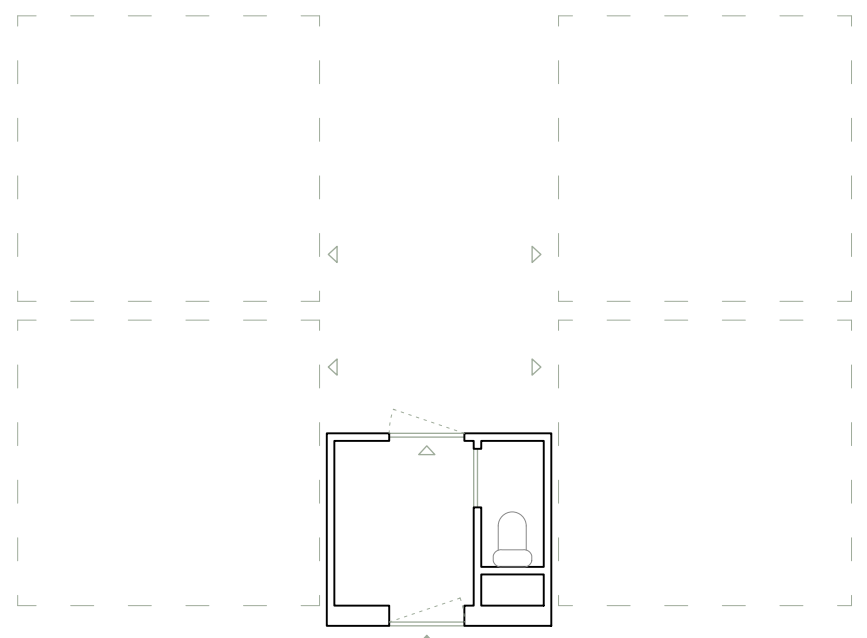
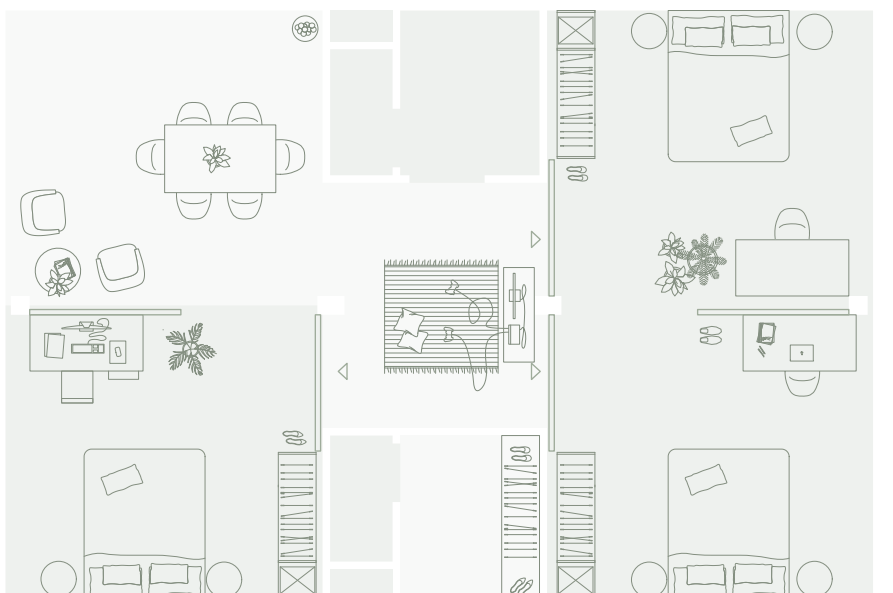
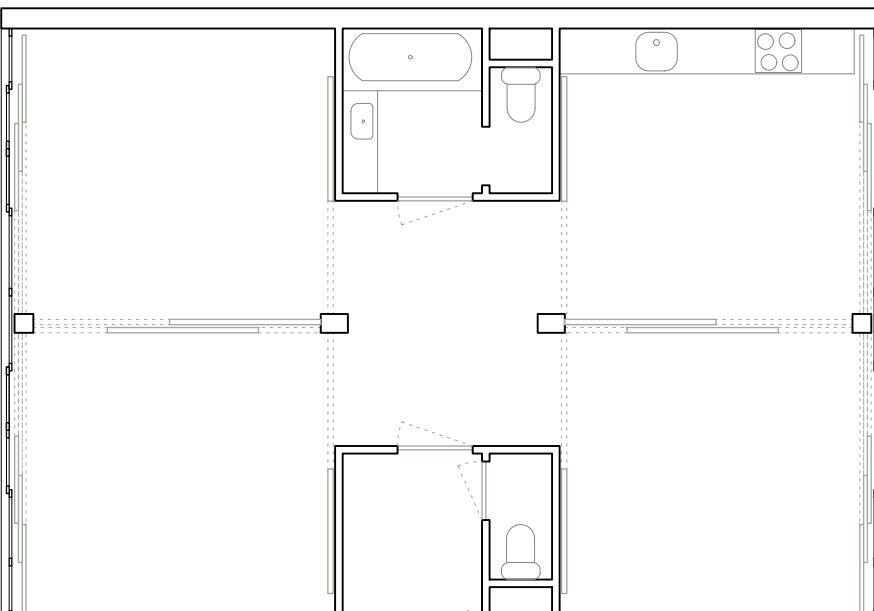
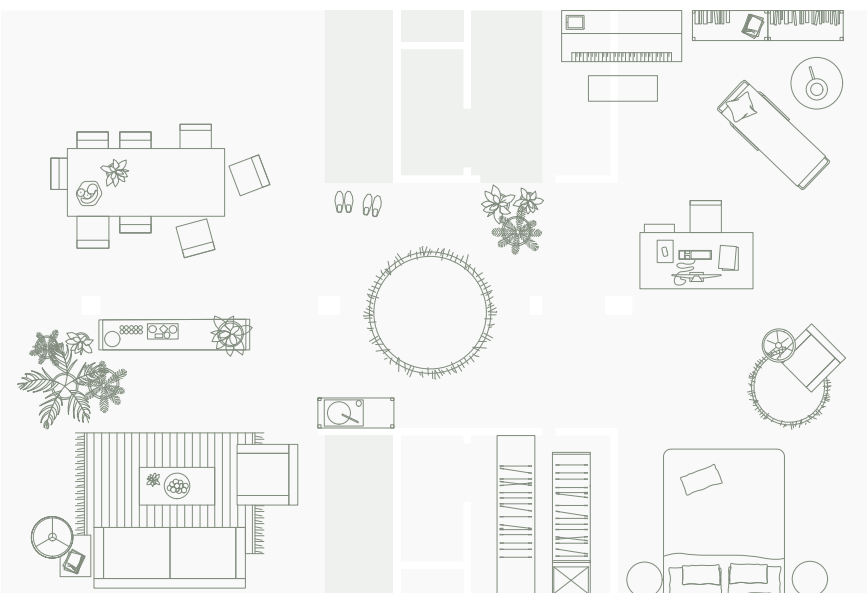
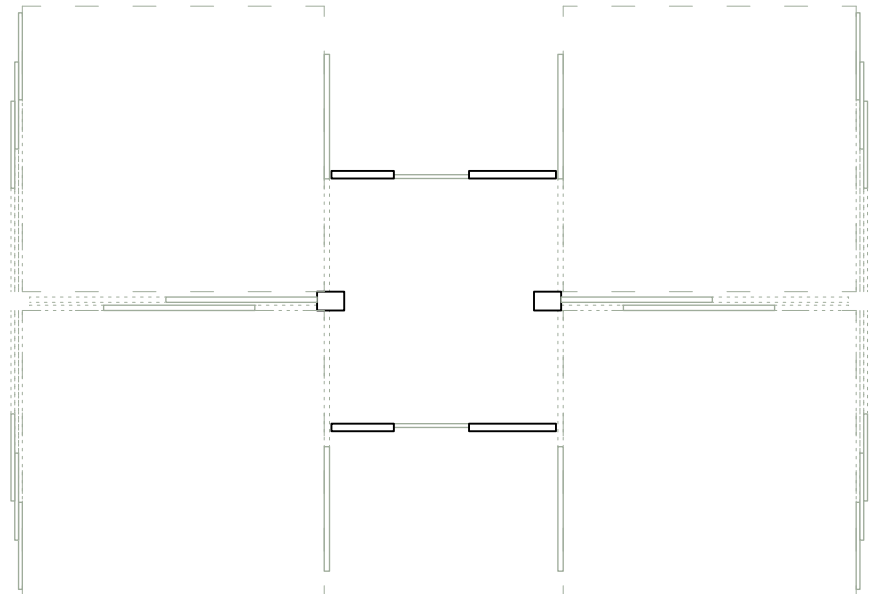
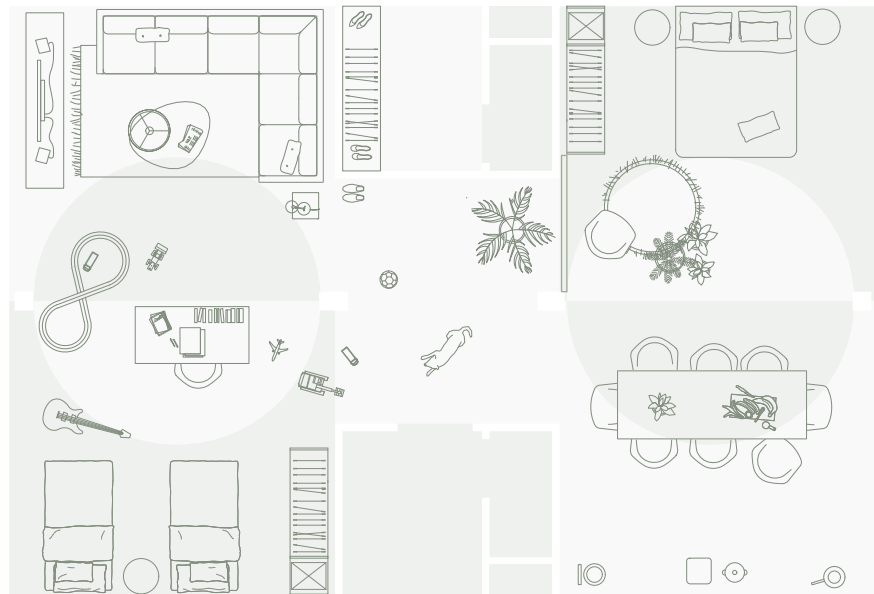
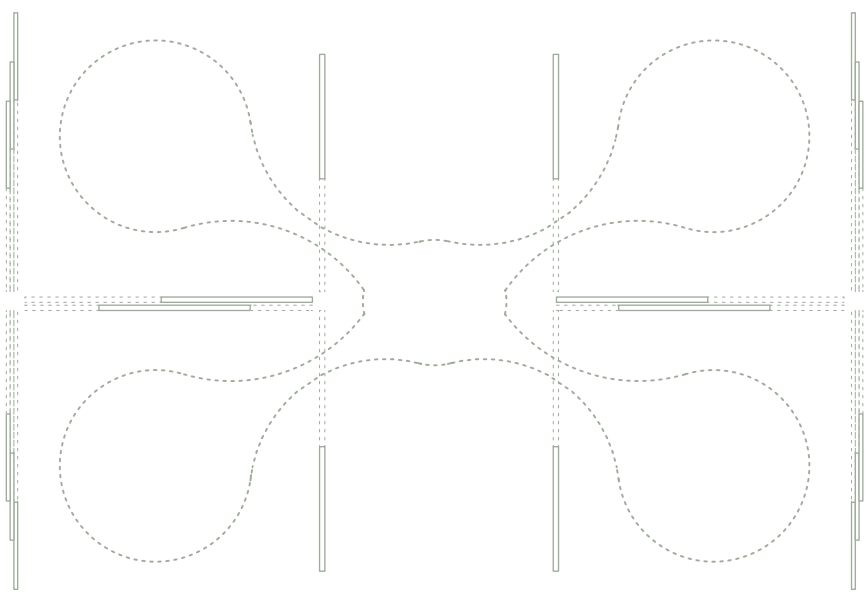

P

A

S

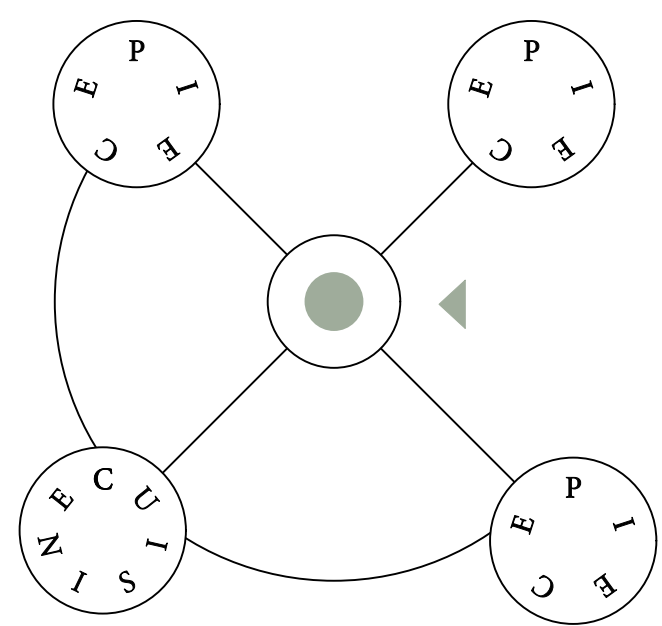
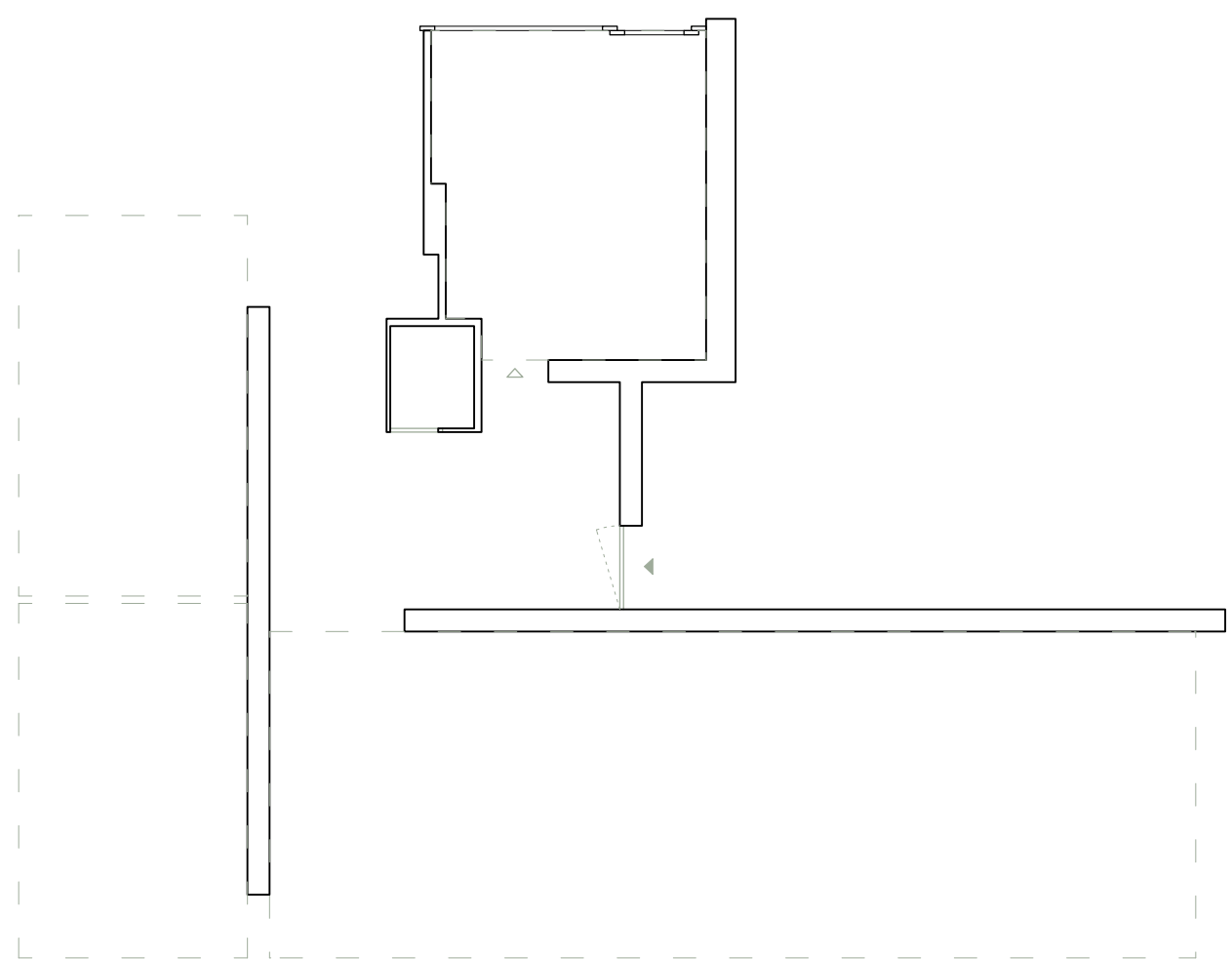
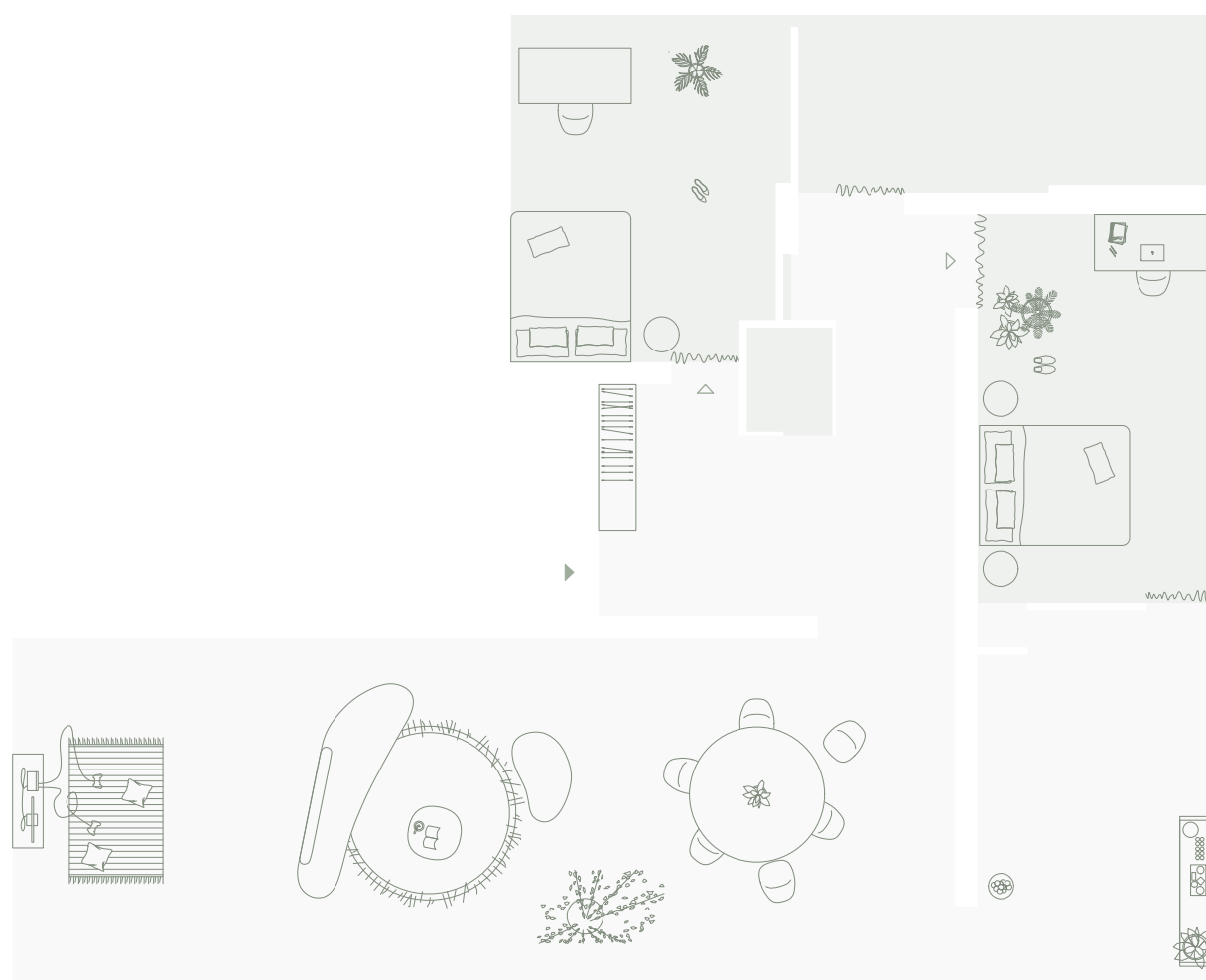
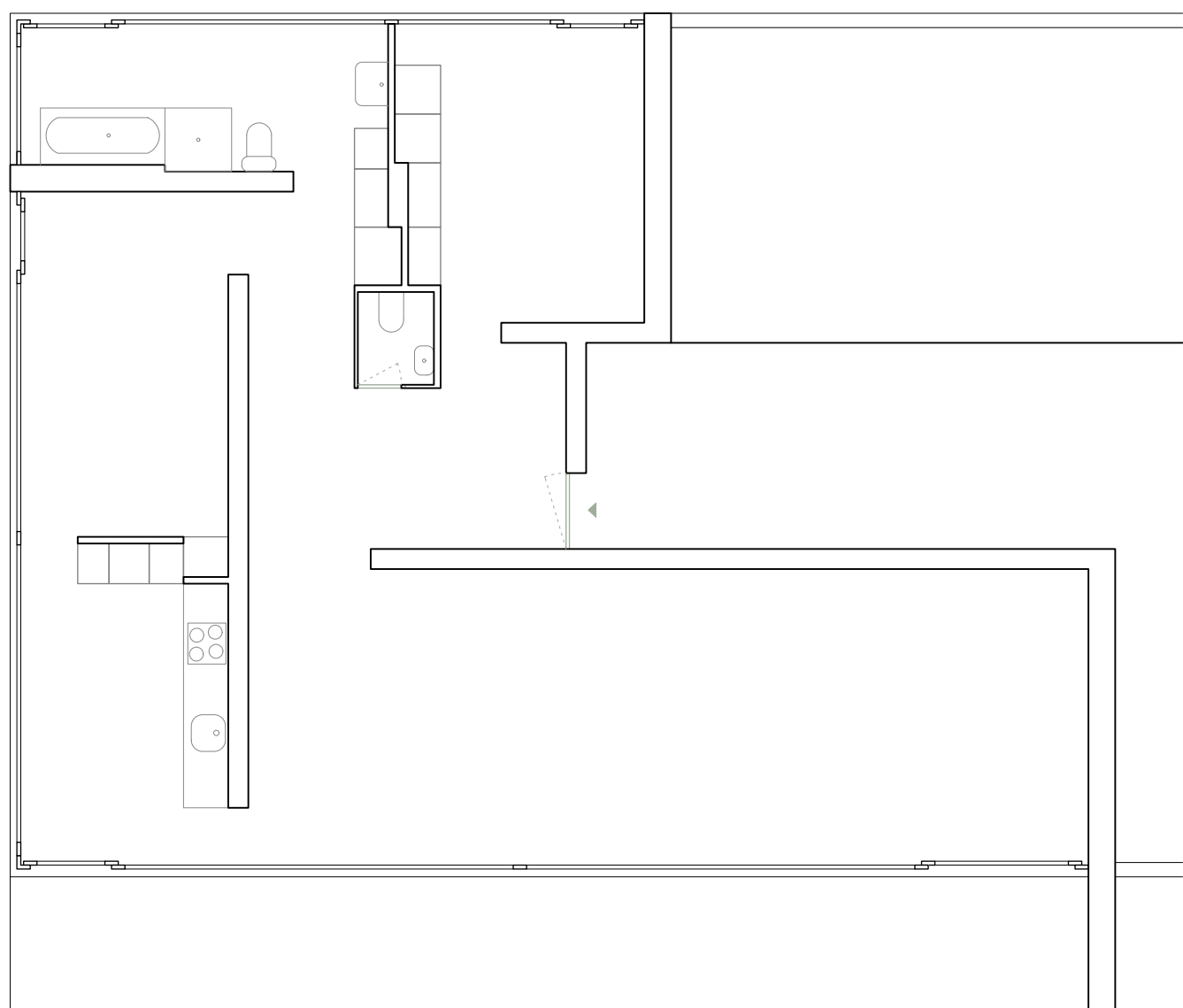
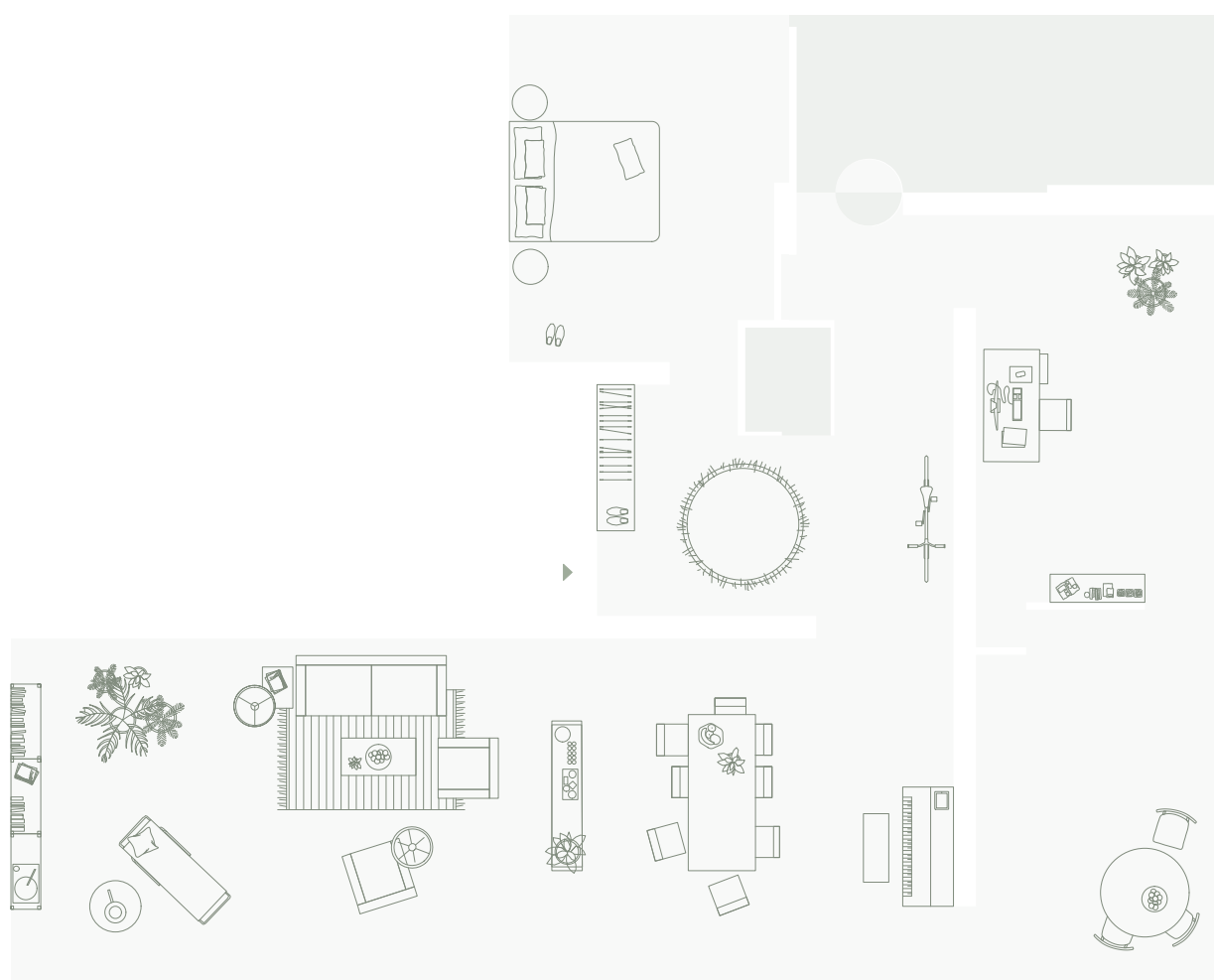
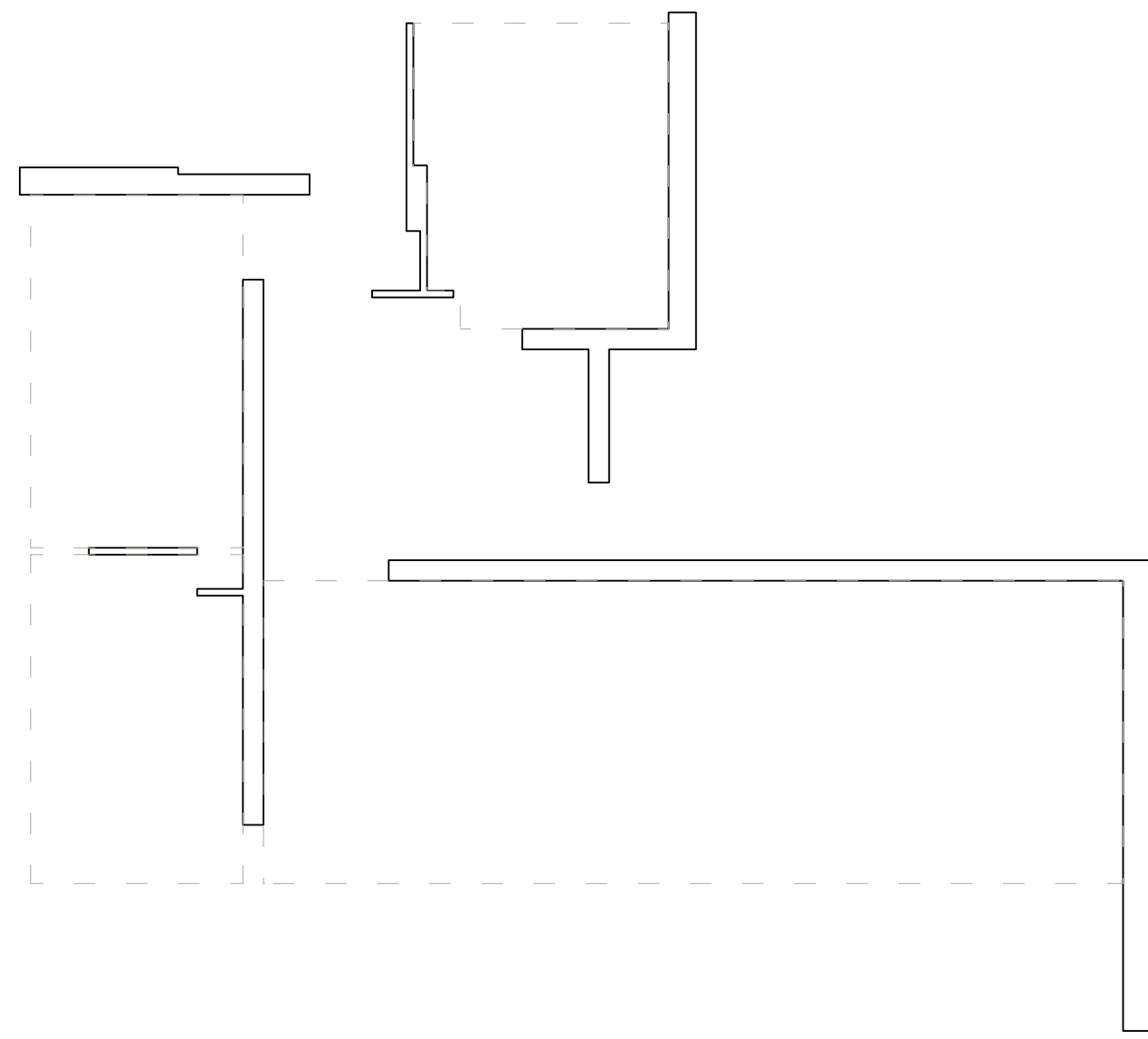
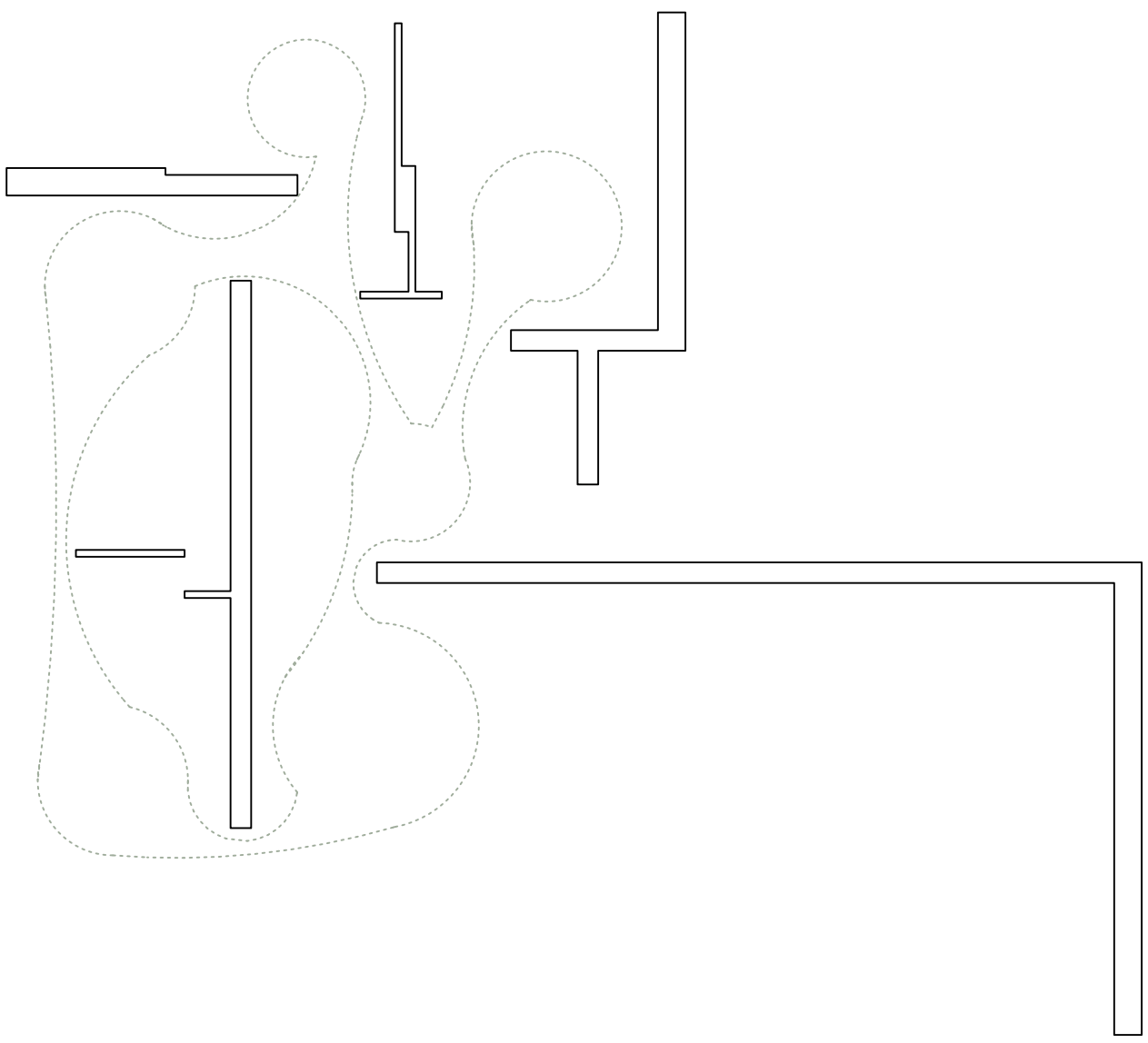

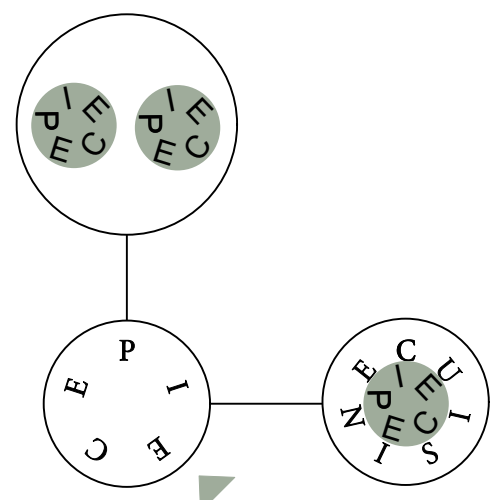
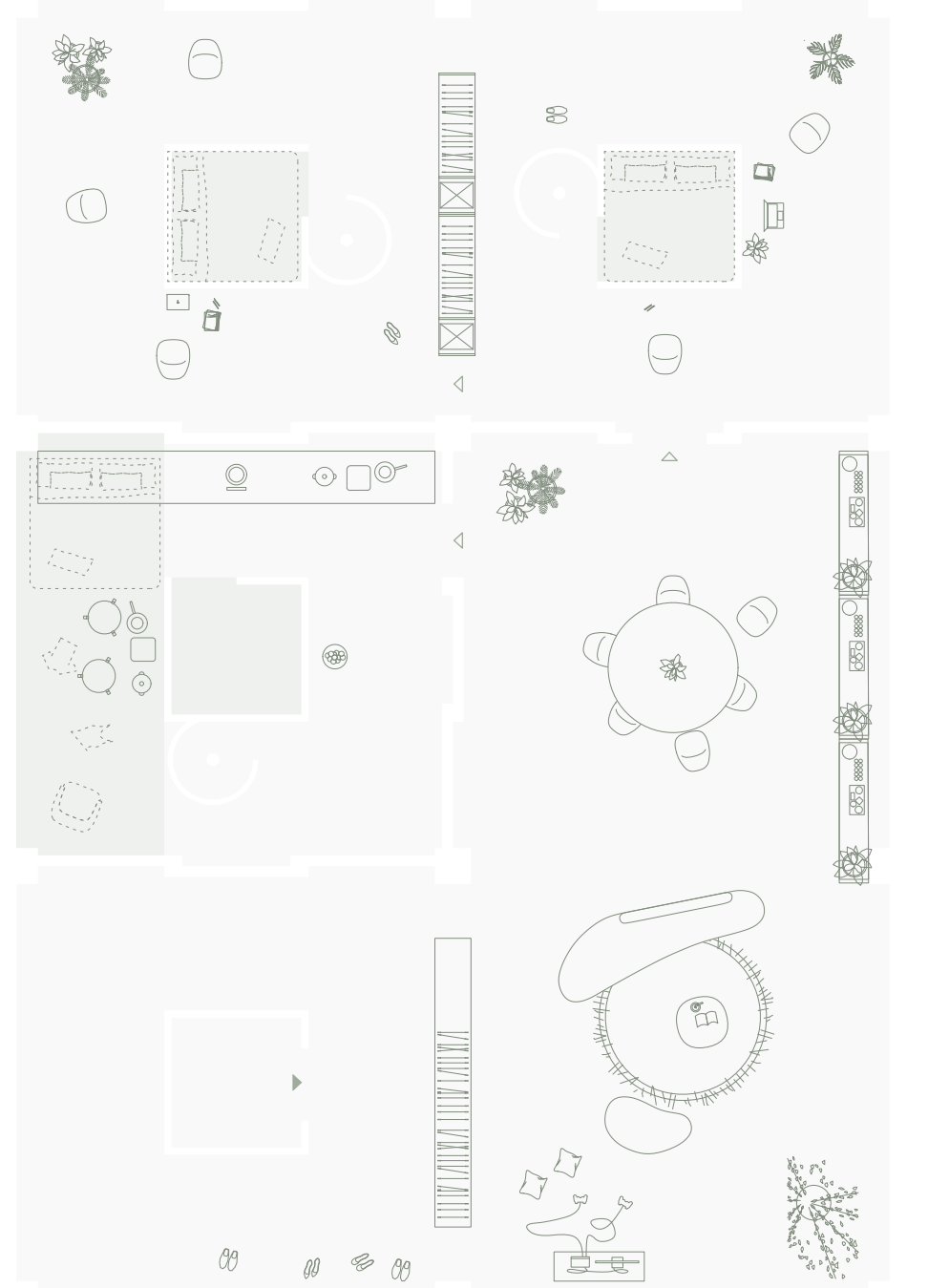
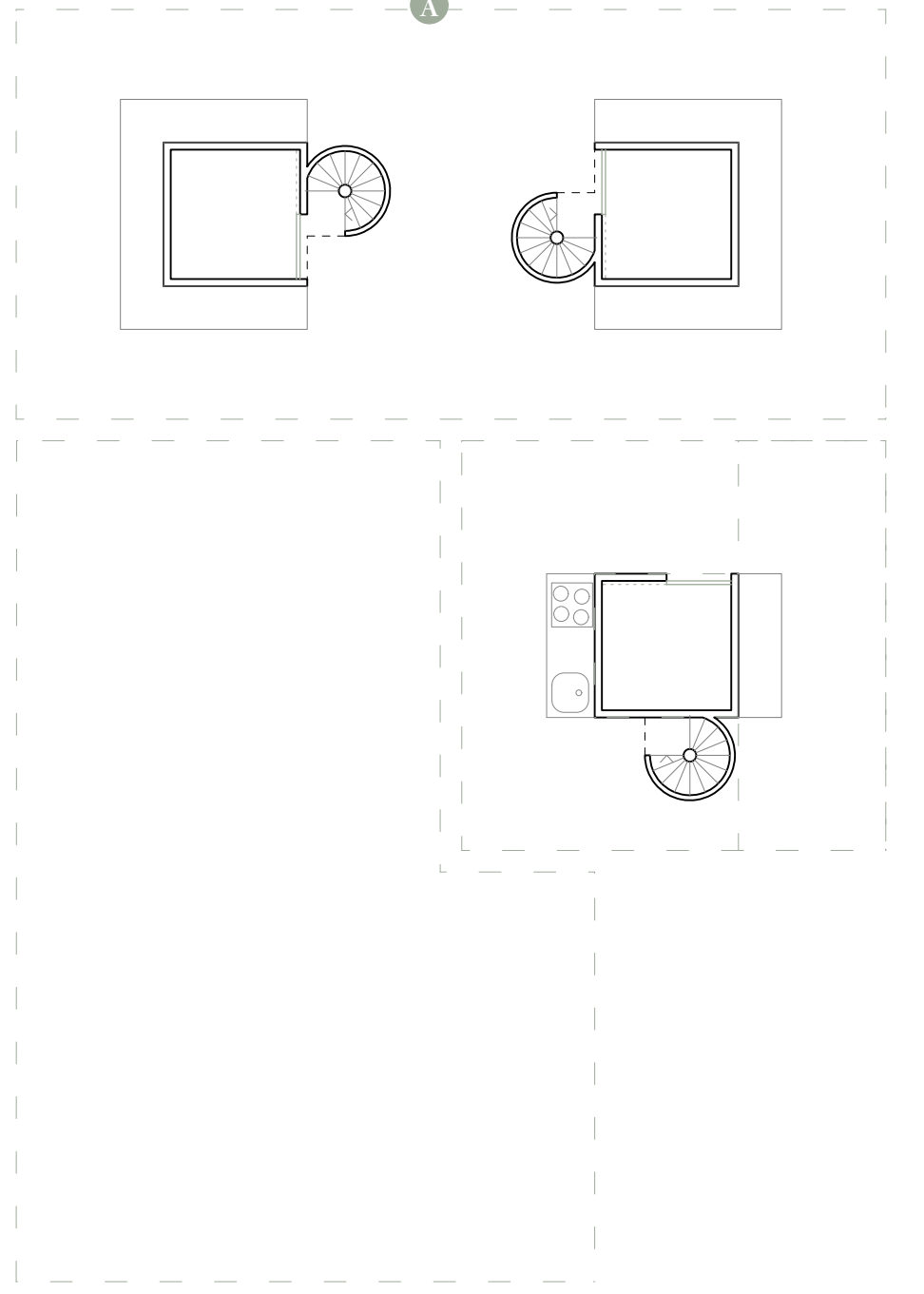
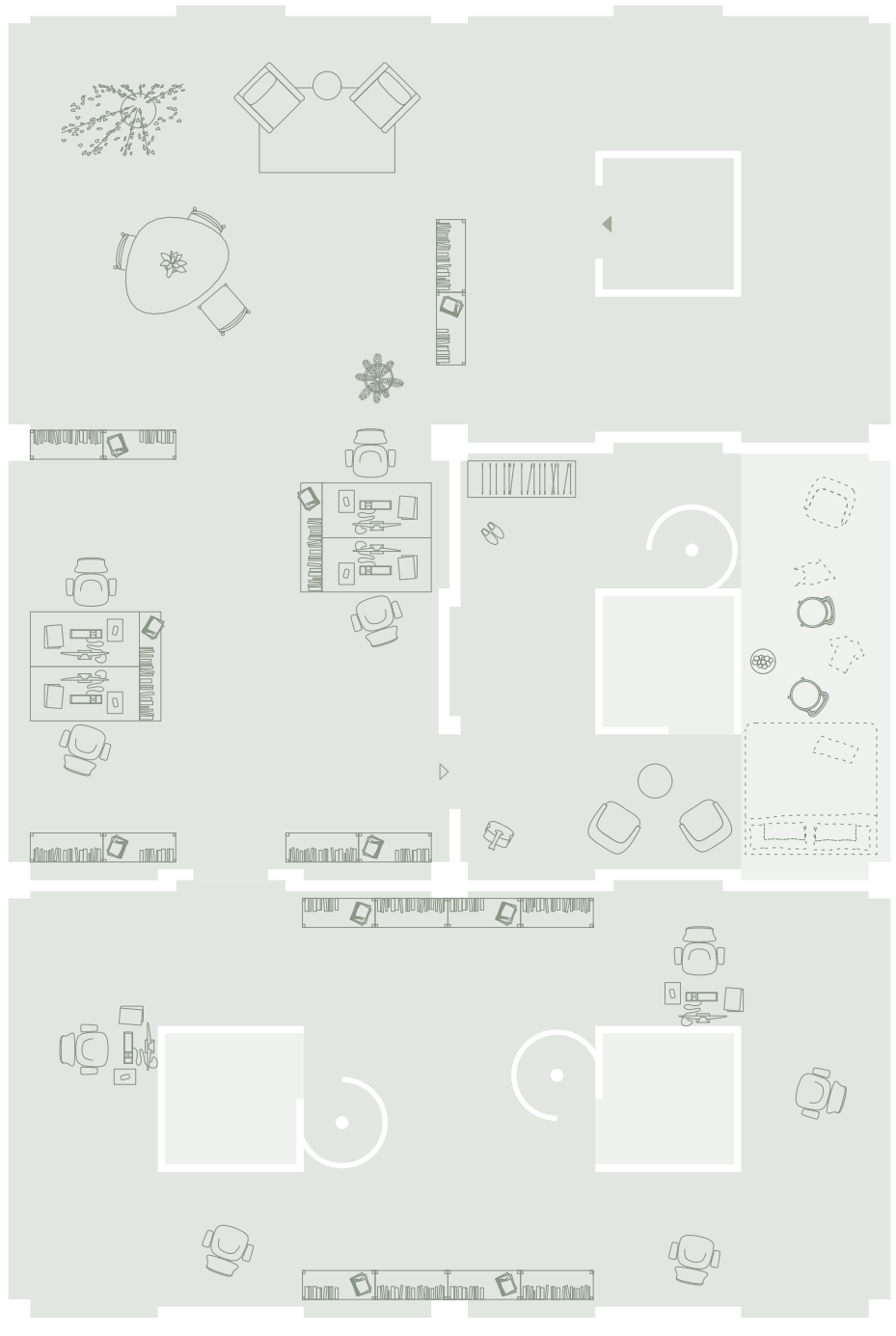
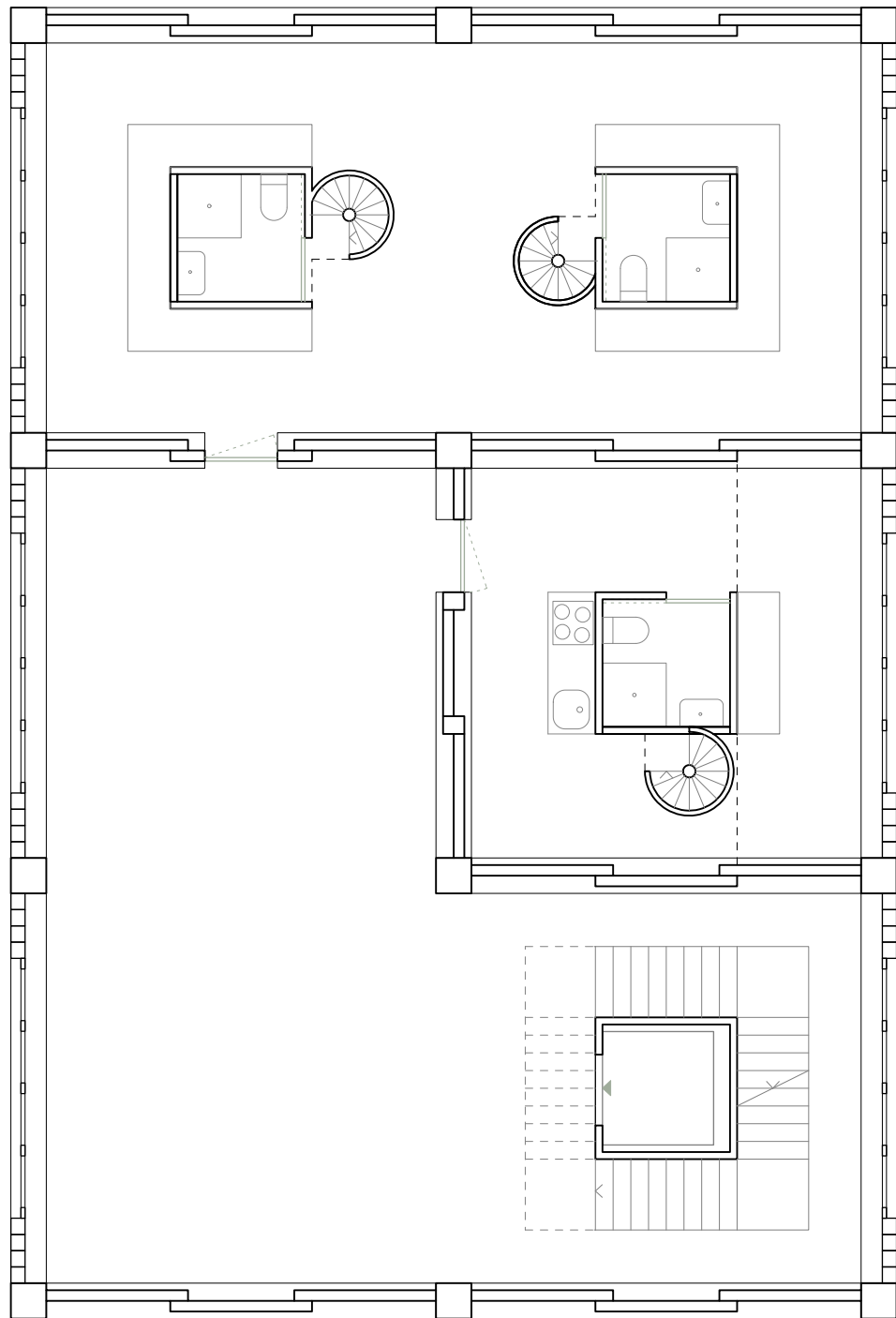
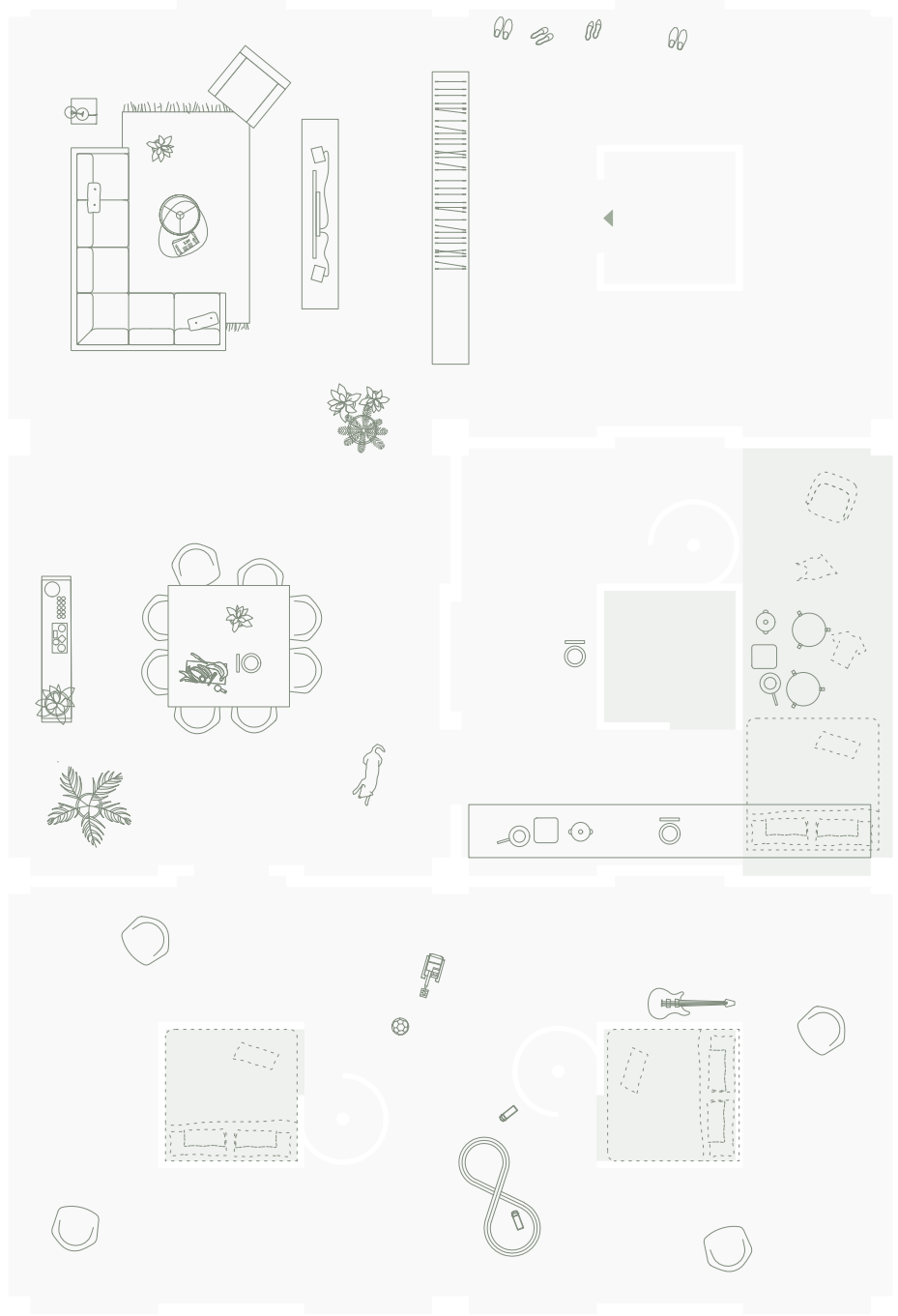
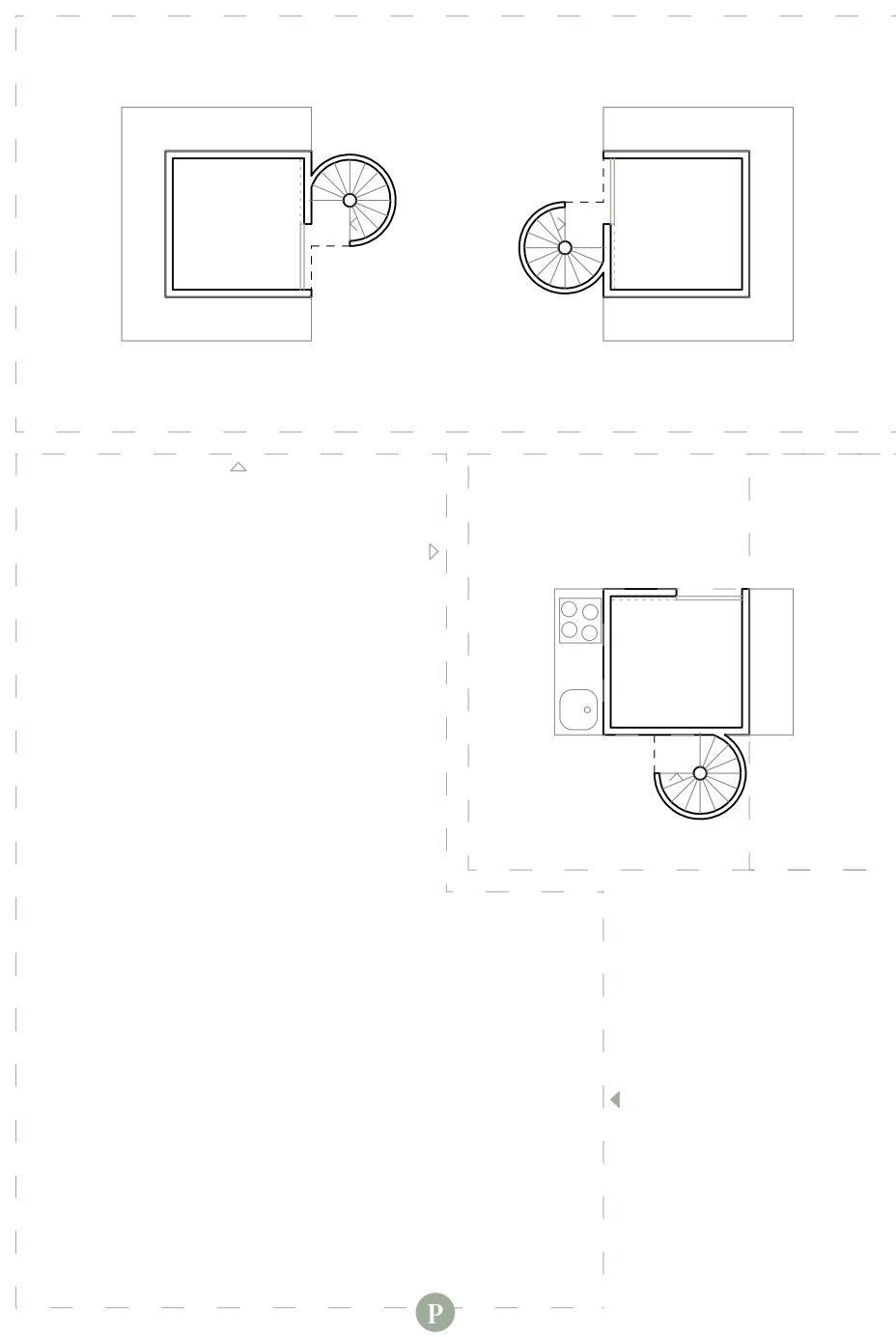
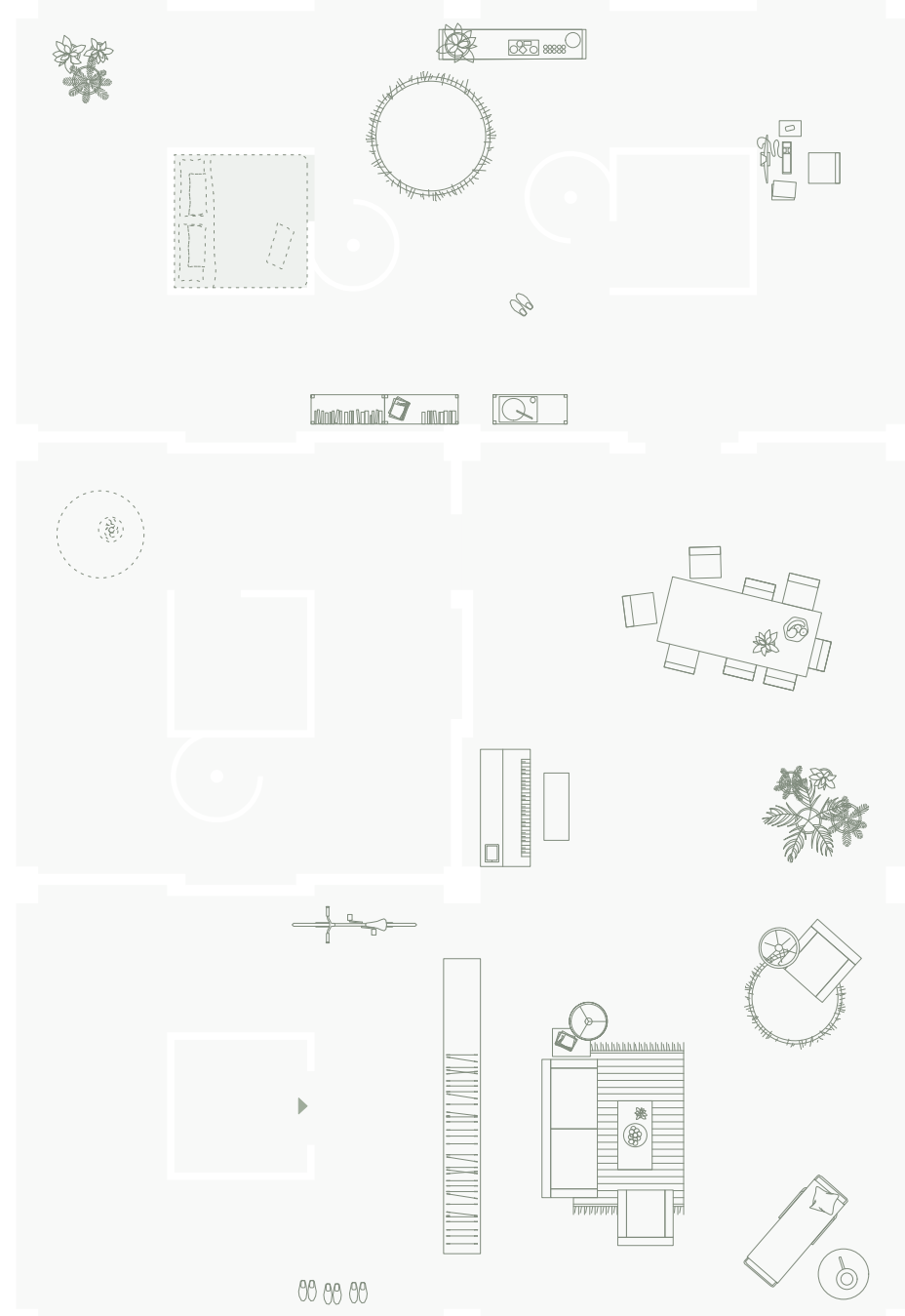
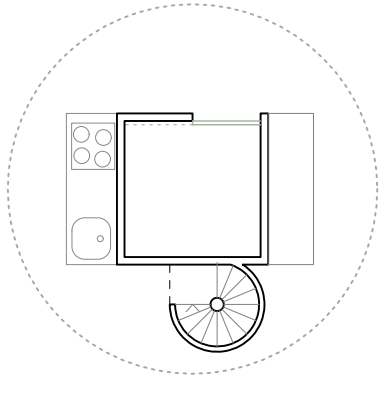
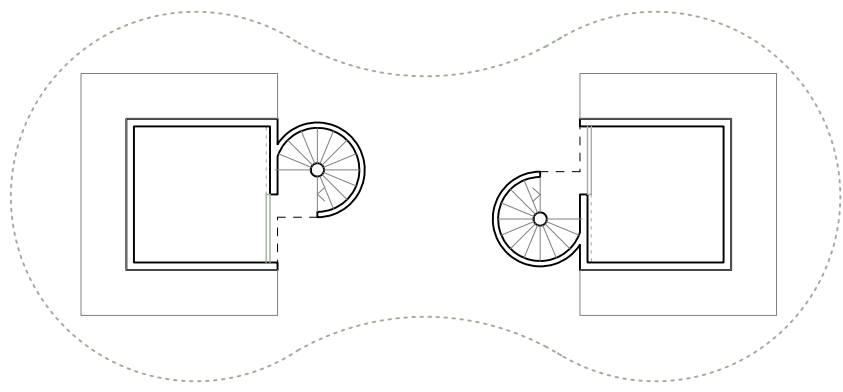

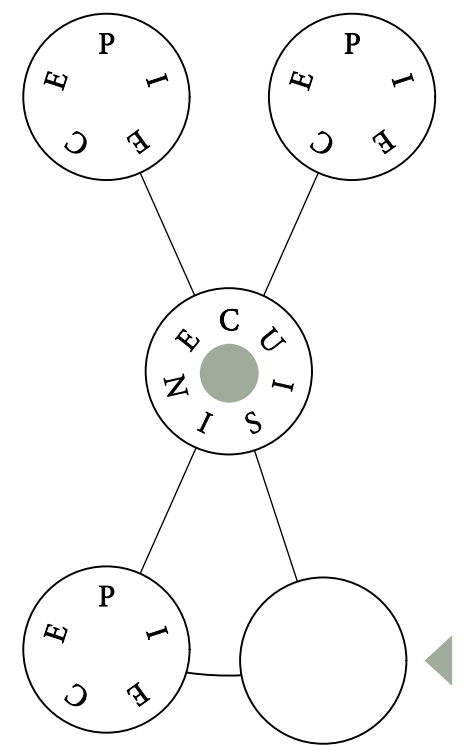
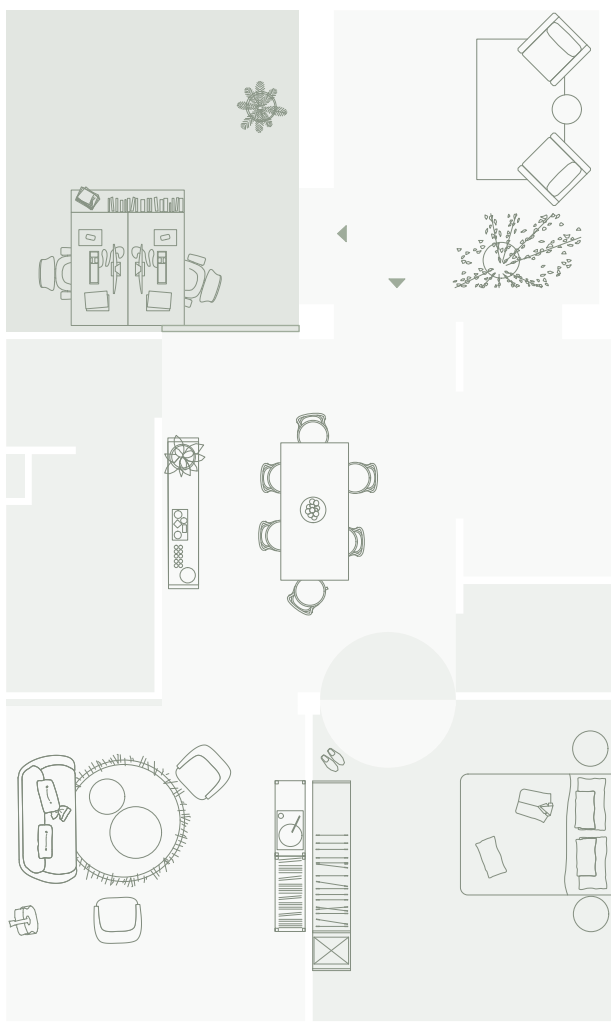
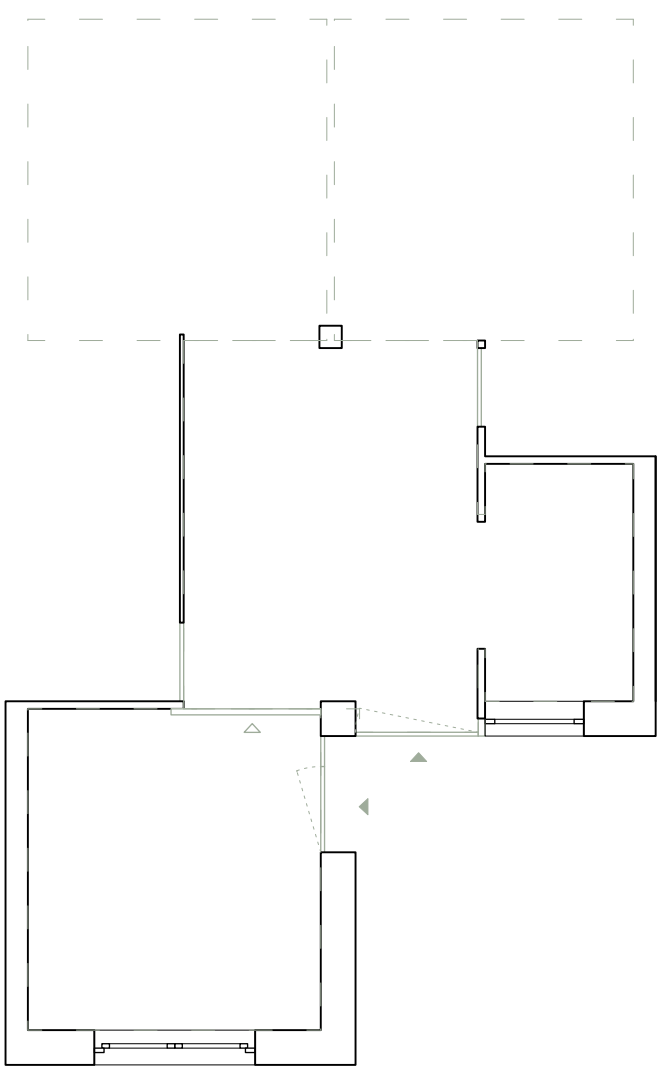
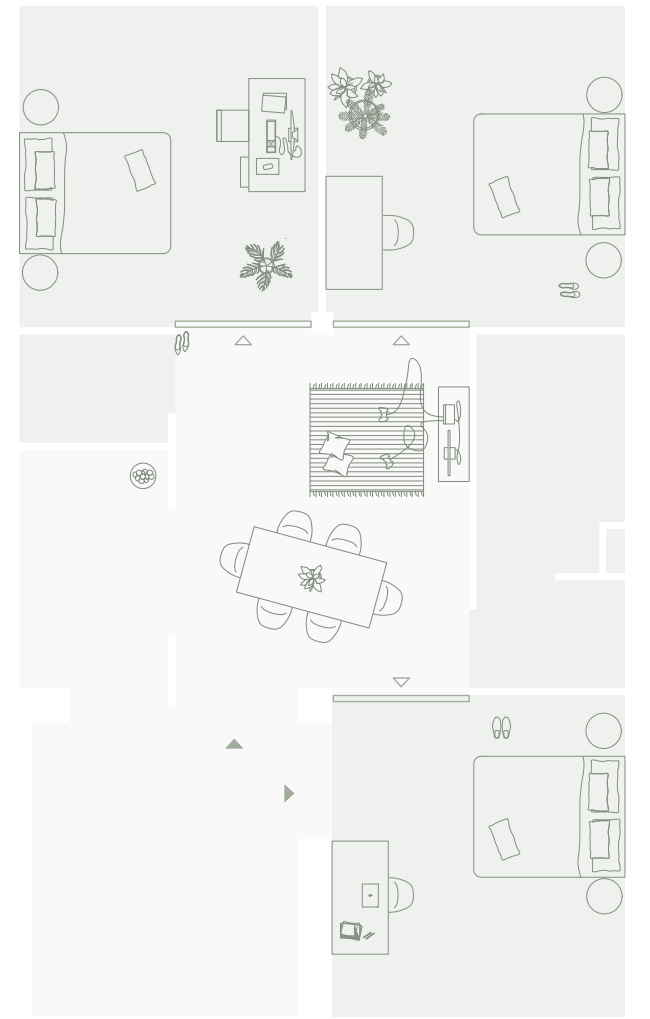
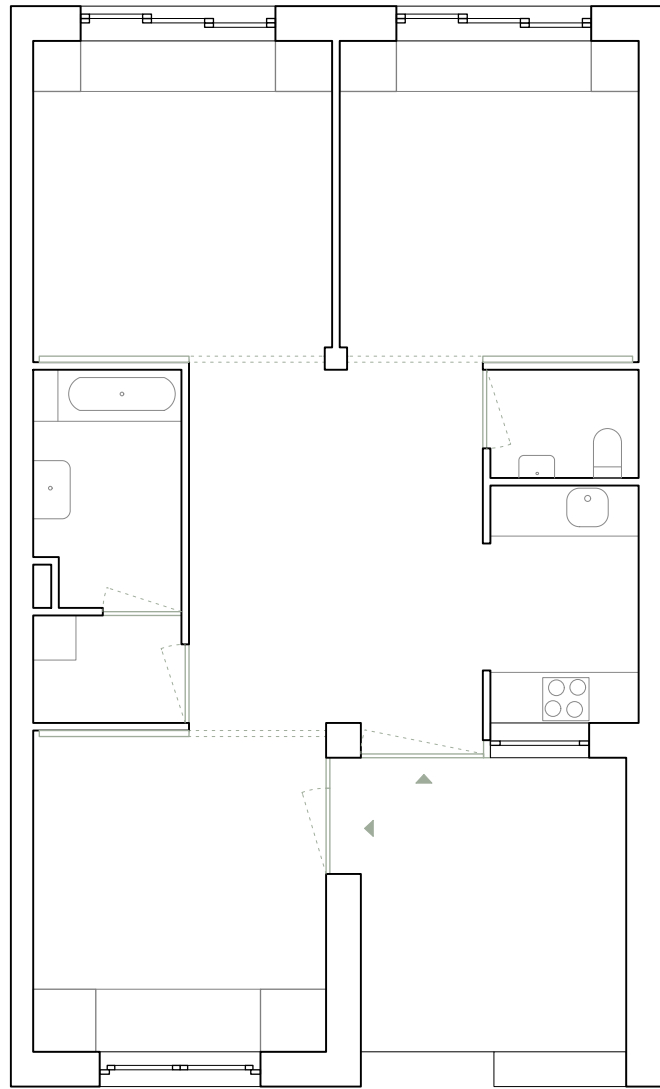
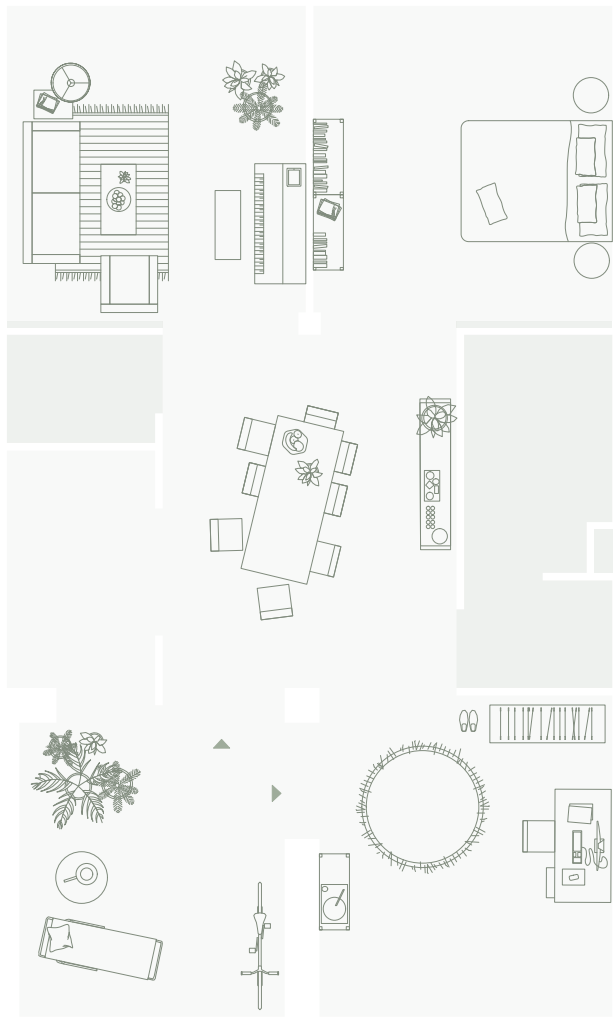
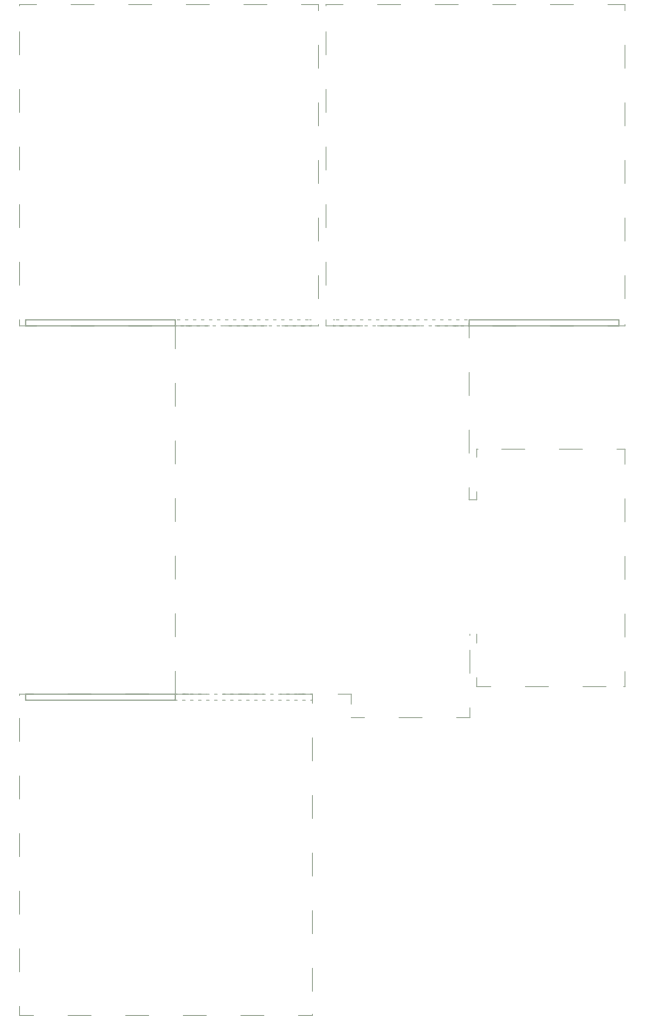
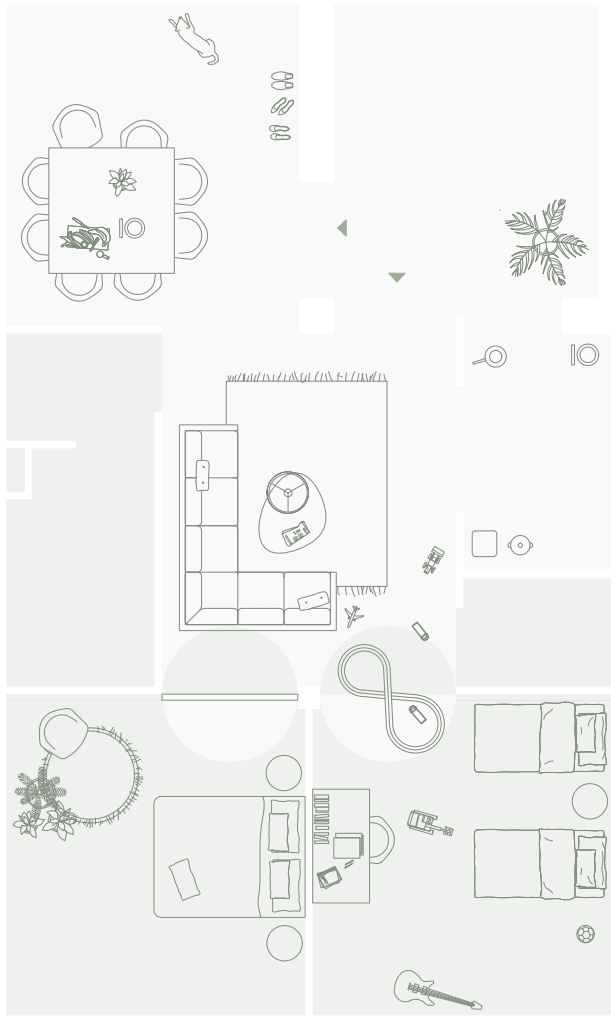
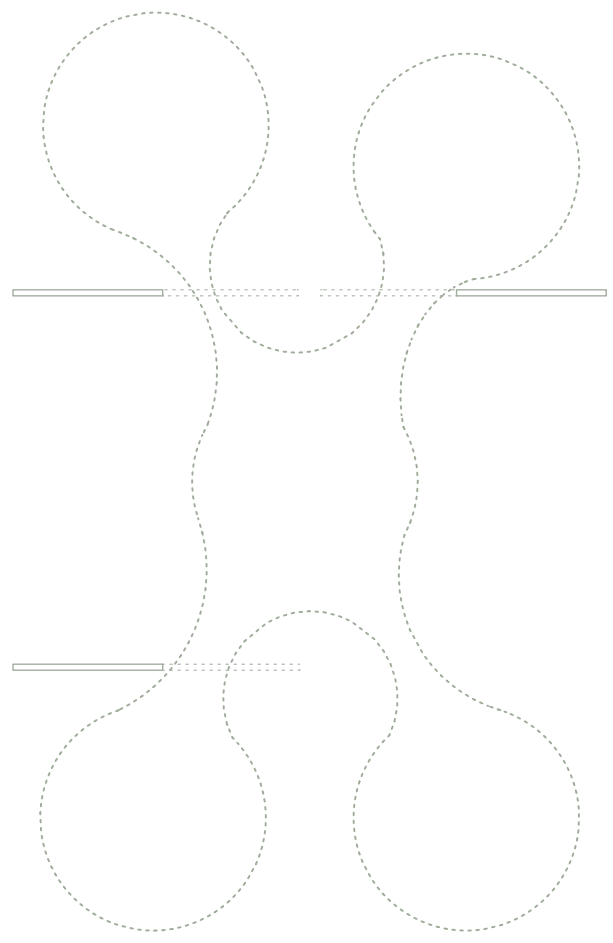

I

A

P

S

