

Optimal Operation of Dynamic Processes

by Dominique Bonvin
Institut d'Automatique, EPFL
CH - 1015 Lausanne, Switzerland

Abstract

The optimal operation of two real-life examples, a fixed-bed bioreactor used in wastewater treatment and a liquid-phase semi-batch reactor, is formulated from an engineering point of view. It is argued that the process dynamics play a crucial role with respect to the optimal operational strategy. Optimization approaches without and with the use of a model are proposed and implemented on the two processes.

1. Introduction

This contribution discusses the importance of process dynamics with respect to the optimal operation of discontinuous (batch or semi-batch) chemical and biological processes. The need for a model and its various uses are discussed.

In order to be somewhat concrete, the discussion centers around two real-life examples of discontinuous processes : a fixed-bed bioreactor used in wastewater treatment and a liquid-phase semi-batch reactor used in the diketene chemistry. Both processes operate in a semi-batch mode, and the objective of the study is to determine the feeding strategy that is optimal with respect to some specific performance criterion. Other important optimization issues such as the sizing of the process or the fine-tuning of the chemical or biological reactions via temperature and/or solvent selection are not considered here. It is however assumed that such an optimization study has been performed prior to this optimization of the operational strategy. The two real-life examples are presented next.

2. A Fixed-bed Bioreactor

2.1. Process description and operational objectives

Bioreactors have been used increasingly in wastewater treatment due to their capability of consuming various chemicals present therein. Recently, the plug-flow fixed-bed bioreactor has emerged as an important treatment method (Pujol *et al.* 1993).

The bioreactor, shown schematically in Figure 1, is an aerobic co-current up-flow fixed-bed reactor for wastewater treatment (Grady and Lim 1980). The reactor is filled with a stationary support (*viz.*, fixed bed) on which the micro-organisms are attached. They grow by consuming oxygen and the carbonaceous (organic) ingredients, thereby forming a biofilm around the support. As the biofilm grows, the reactor volume available for liquid and air flows is reduced. To avoid clogging, the normal operation has to be stopped and the reactor backwashed. Hence, such a reactor is considered as a semi-continuous process.

File Name : BIOFORenglish_petit.eps

Title : BIOFORenglish_petit.eps

Creator : Canvas 3.5

CreationDate : Lun, 4 nov 1996 12:56

Fig. 1. Schematic view of the fixed-bed bioreactor

Due to the non-availability of dynamic models, fixed-bed bioreactors for wastewater treatment have normally been operated with constant inlet concentration and constant feed flowrate. Yet, one is often interested in using the reactor in a more efficient manner. Two criteria which reflect possible economic objectives (one maximizing the space efficiency and the other the time efficiency) have been proposed (Benthack *et al.* 1996). The inlet concentration and feed flowrate are considered as variables that can be manipulated for the purpose of this optimization. The inlet concentration is varied by recycling the effluent.

To optimize the efficiency of wastewater treatment, a dynamic model that adequately describes the main phenomena and/or trends of the system (i.e. a macroscopic model) is required. Though optimization with differential and algebraic constraints is a well researched field, little work has been reported on the dynamic optimization of fixed-bed bioreactors. Work on dynamic optimization is, in general, based on Pontryagin's Maximum Principle (PMP) (Bryson and Ho 1969). This requires the solution of a two-point-boundary-value problem which is computationally expensive.

2.2. Optimal operation

The main objective of wastewater treatment processes is to treat the given wastewater in a space- and time-efficient manner such that the effluent meets the specified quality requirements. For a given biofilter, the problem of selecting the optimal operating conditions (i.e., choosing the wastewater flowrate $Q(t)$ and the input concentration $S_{in}(t)$) is addressed here. The two quantities that will be maximized are the amount of substrate treated, (a) during one cycle (J_a) and (b) per unit of cycle time (J_b). In both cases, the same operational constraints apply. These include constraints on the feed flowrate, feed composition and effluent concentrations. The first criterion, J_a , looks for a space-efficient procedure. This is of particular interest when the backwashing procedure is energy intensive and expensive. On the contrary, with J_b , a time-efficient operation is preferred so that more wastewater can be treated per unit time. The time efficiency is defined with respect to the cycle time, t_c , which not only includes the operation time t_f but also the time required for backwashing t_w : $t_c = t_f + t_w$. The free terminal time optimization problems can be formulated as follows:

$$(1) \quad \max_{Q(t), S_{in}(t)} \quad J_a \text{ or } J_b$$

s.t. system p.d.e.

$$\max_z \quad X(z, t_f) = X_{max}, \quad S_{out}(t) \leq S_{lim}$$

$$Q_{lb} \leq Q(t) \leq Q_{ub}, \quad S_{lb} \leq S_{in}(t) \leq S_{ub}$$

$$(2) \quad J_a = \int_0^{t_f} Q \frac{S_w(S_{in} - S_{out})}{S_w - S_{out}} dt$$

$$J_b = \frac{1}{t_c} \int_0^{t_f} Q \frac{S_w(S_{in} - S_{out})}{S_w - S_{out}} dt \quad (3)$$

where $[Q_{lb}, Q_{ub}]$ and $[S_{lb}, S_{ub}]$ are the ranges of admissible values for the feed flowrate and the inlet substrate concentration, respectively, and S_{lim} the maximal acceptable effluent concentration. X_{max} is the maximal permissible biomass concentration attaining which, at any height, the column has to be backwashed. S_w is the concentration of the wastewater that needs to be cleaned and $\left(\frac{S_{in} - S_{out}}{S_w - S_{out}}\right)$ is the fraction of the original wastewater stream that actually enters the reactor, taking recycling into consideration.

The developments that follow are based on monotonicity arguments, i.e., the derivative of the costs with respect to certain variables being always positive. Then by invoking PMP, it can be shown that some of the variables should be at their constraint limits. Though these arguments can be established analytically, for the sake of brevity, we will only state the results and provide intuitive arguments substantiating them.

Monotonicity with respect to S_{out} : Both costs increase when the limit on S_{out} is relaxed i.e., $\frac{J_a}{S_{out}} > 0$ and $\frac{J_b}{S_{out}} > 0$. When S_{out} is allowed to increase, Q can be increased for that purpose. Compared to the increase in Q , the decrease in $\frac{S_{in} - S_{out}}{S_w - S_{out}}$ is only marginal and, hence, J_a increases. Also, since t_f is insensitive to changes in Q , J_b increases with S_{out} . From PMP, the optimum is achieved on the constraints which, in this case, means $S_{out} = S_{lim}$ for maximizing both J_a and J_b .

Optimization of the cost J_a : Having set $S_{out} = S_{lim}$, one has to decide how the two input variables can be manipulated along this constraint surface so as to maximize J_a . A sensitivity analysis leads to :

$$\left(\frac{J_a}{Q}\right)_{S_{out} \quad S_{lim}} > 0 \quad (4)$$

From PMP, one concludes that the optimal choice is $Q^*(t) = Q_{ub}$. However, since we cannot control the effluent concentration using Q , the inlet concentration needs to be adjusted to meet $S_{out} = S_{lim}$. Intuitively, the reason why Q has to be at its maximum for maximizing J_a can be explained as follows : Seeking a set of input variables that result in space-efficient wastewater treatment is 'equivalent' to having a more uniform biomass distribution. Such a situation can be achieved with a larger Q . Hence, increasing Q is beneficial as far as maximizing J_a is concerned.

Optimization of the cost J_b : In this case, a sensitivity analysis along the constraint surface, $S_{out} = S_{lim}$, results in :

$$(5) \quad \left(\frac{J_b}{S_{in}} \right)_{S_{out} = S_{lim}} > 0$$

From PMP, the optimal choice is $S_{in}^*(t) = S_{ub}$. Hence, the feed flowrate should be adjusted to meet the limit on S_{out} . The reason for S_{in} to be at its maximum for time efficiency can be explained as follows : Time-efficient wastewater treatment is 'equivalent' to maximizing the substrate consumption rate r_S . Since S_{in} has a more direct and stronger influence on r_S than Q , S_{in} must be at its upper bound.

The feasible region and the sensitivities at a given point in time are summarized in Figure 2. The constraint surface and the optima move towards the top right corner as time increases.

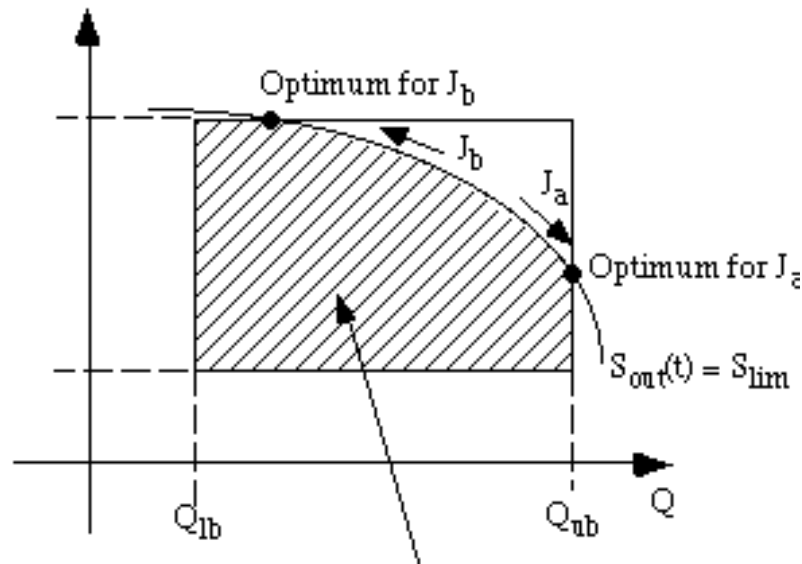

Fig. 2. Feasible region at time t

2.3. Optimal operational modes

For both optimization criteria proposed in the previous section, it is found that one of the input variables (S_{in} or Q) has to be adjusted such that the effluent quality is met exactly. This can be achieved either by explicitly solving the corresponding dynamic optimization problem or by imposing a feedback structure that regulates S_{out} at S_{lim} . An explicit solution requires a good dynamic model and a considerable amount of computational time. On the other hand,

solving the problem implicitly by imposing a feedback structure is computationally efficient and can be implemented on-line easily. The set point for the feedback system is S_{lim} and the controller so designed that the output tracks the reference. However, there is no guarantee that the output will be equal to S_{lim} at all times and, hence, the scheme should be considered suboptimal.

Yet, the advantages are considerable : (i) There is no necessity to obtain an exact model, as long as the observed profiles follow the trends indicated in the previous sections. (ii) The feedback control provides a certain amount of robustness. This is extremely important, as biological systems are inherently non-deterministic and are characterized by large perturbations and parameter variations. Considering the system at hand, especially its biological nature, the best choice would be to use a suboptimal feedback scheme rather than a 'true' optimal feedforward action. The price paid, however, is that the effluent substrate concentration needs to be measured. The following feedback structures have been investigated in this study:

- Mode A: $Q(t) = Q_{ub}$ and feedback control of S_{out} by manipulating the inlet concentration S_{in} . A PI-controller is used for this purpose (Figure 3).
- Mode B: $S_{in}(t) = S_{ub}$ and feedback control of S_{in} by manipulating the wastewater flowrate Q . A PI-controller is used for this purpose (Figure 4).

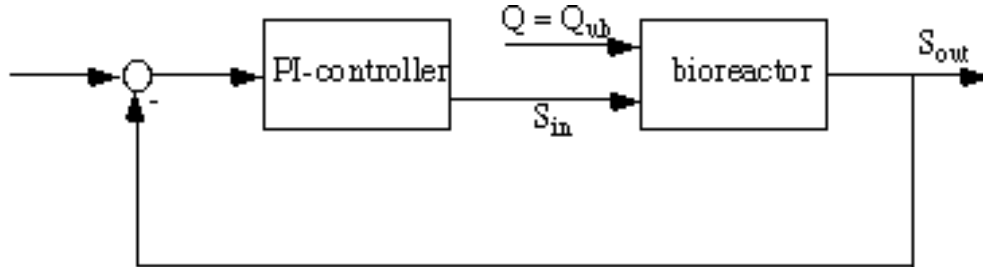

Fig. 3. Block diagram for Mode A

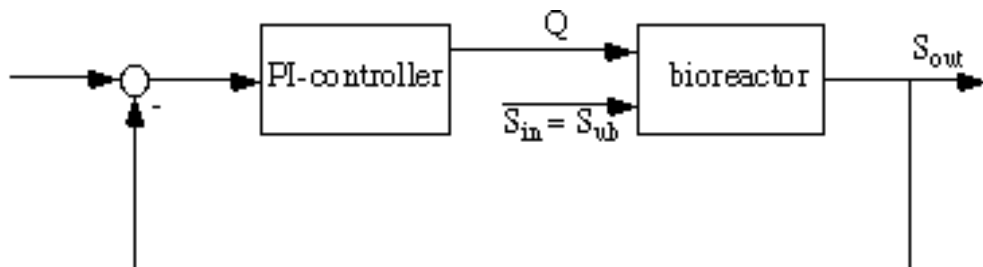

Fig. 4. Block diagram for Mode B

Input profiles for the operational Modes A and B are shown in Figures 5 and 6, respectively. The inlet concentration is the manipulated variable in operational Mode A and the feed flowrate in Mode B. The biomass inside the column increases with time, which allows higher inlet concentrations to be used in Mode A and higher feed flowrates in Mode B. The initial oscillations can be attributed to transients in the feedback loop. Also, the initial filling of the reactor affects these transients as the operation during this period is essentially open loop. Control action can only start when an effluent is available.

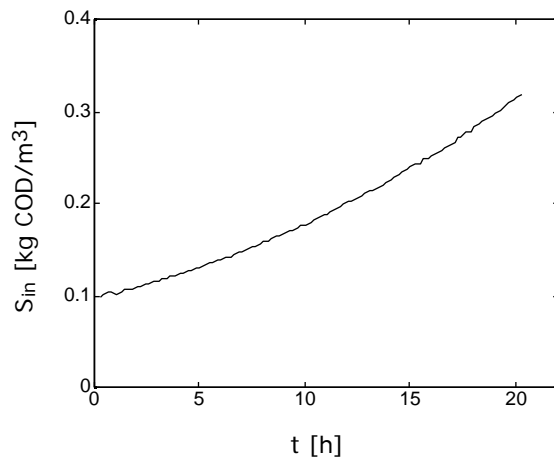

Fig. 5. Input profile for Mode A

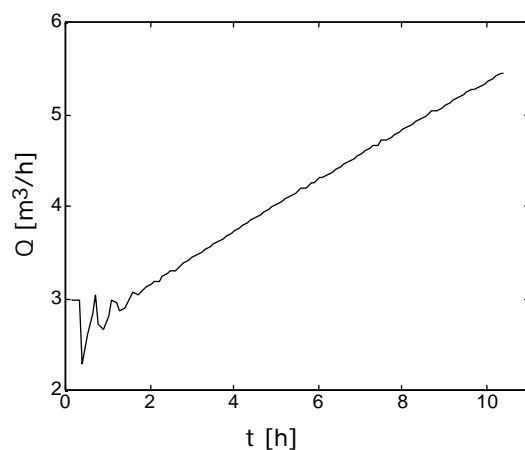

Fig. 6. Input profile for Mode B

3. A Semi-batch Reaction System

3.1. Process description and operational objectives

In batch chemical processes, materials typically pass consecutively through several unit operations such as reaction, crystallization, centrifugation, drying, etc. As undesirable variations in one production step often cannot be fully compensated for downstream, or only at high costs, corrections have to be made where the variations appear, which is often at the reaction step. Operating conditions that change from batch to batch may result in unacceptable variations of product quality, additional operations or, still worse, the loss of the batch. Consequently, it is of great importance to supervise and optimize the operation of each batch individually. Very limited *experimental* work has been published regarding the on-line optimization of batch reactors. Reasons for this are discussed in Ruppen (1994).

The problem investigated here is typical of the batch processing of specialty chemicals. Pyrrole reacts with diketene to 2-acetoacetyl pyrrole. In a main side reaction, diketene dimerises to the by-product dehydroacetic acid. The reagent diketene is generally utilized at production site because of its extreme reactivity and hazardous properties. Although optimal catalysts and reaction temperatures can be found, one cannot exclude many undesired by-products such as diketene polymers. In small quantities, diketene polymers color the desired product yellow to brown. Because of their limited solubility in organic solvents, too large quantities of diketene polymers lead to precipitation, which can be the cause of further problems. Moreover, small amounts of impurities can significantly change the selectivity between the desired and undesired products and, therefore, it is difficult to obtain the same quality for successive batch runs. Most runs are monitored by taking frequent samples which are analyzed off-line because the available on-line measurements do not provide the information needed to estimate the actual state of the reactor.

The following model of the reaction system can be proposed :

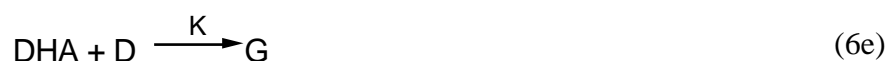
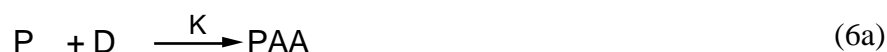

with P: pyrrole, D: diketene, K: pyridine (catalyst), PAA: 2-acetoacetyl pyrrole, DHA : dehydroacetic acid, F and G: by-products.

The experimental work of this study was performed on the bench-scale calorimeter BSC-81, originally developed by CIBA-GEIGY. That prototype was later modified and commercialized by METTLER-TOLEDO under the name Reaction Calorimeter RC-1. Both calorimeters are ideal tools for deriving thermal information for batch or semi-batch reaction systems under conditions similar to those encountered in industrial reactors.

The objective of the on-line optimization study consists in minimizing the batch time by adjusting the feed flowrate of diketene while meeting several constraints regarding productivity, selectivity and operational conditions. A schematic view of the semi-batch reactor with the input variable $f(t)$ is shown in Figure 7.

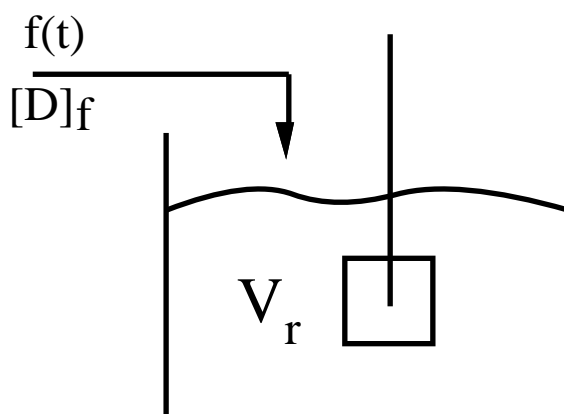

Fig. 7. Schematic view of the semi-batch reactor

3.2. Optimal operation

The problem of optimal operation of a discontinuous reactor has two aspects: the extraction of relevant information about the present batch (estimation) and the use of this information with regard to safety and productivity (optimization). Since deviations from nominal behavior often cannot be predicted before the batch is started, the information has to be acquired on-line, i.e., as the batch proceeds. A major difficulty is the fact that the key variables, such as concentrations, commonly cannot be measured on-line directly. Although industry is interested in on-line information, particularly for safety reasons, one cannot expect suitable sensors for measuring key variables directly to become standard in the near future. The concept of model-based measurements may provide a suitable method to circumvent this problem. However, unique relationships have to exist between measured and estimated variables. Furthermore, these relationships need to be valid over a wide range of operating conditions, thus calling for nonlinear models. For most batch processes, unique relationships between commonly-measured quantities and variables to be estimated do not exist (e.g. rate constants often cannot be uniquely determined

from the measured heat evolution resulting from several reactions). Furthermore, due to the wide range of operation, linear approximations of nonlinear models cannot be applied. Hence, applications in the chemical industry of model-based estimation, such as Extended Kalman filtering, represent solutions that are very problem specific and, sometimes, of limited applications (Agarwal and Bonvin, 1989). A detailed application of estimation techniques to batch reactors is given in De Vallière (1989).

The meaning of 'on-line optimization' as used in this work is briefly introduced. The principle is illustrated in Figure 8. A two-step approach of model identification (estimation) followed by the computation of an optimal control policy (optimization) on the basis of the identified model is used. This helps track a changing process over a wide range of operating conditions. In the following, the sequence of one estimation and one optimization is referred to as an estimation-optimization task (EOT).

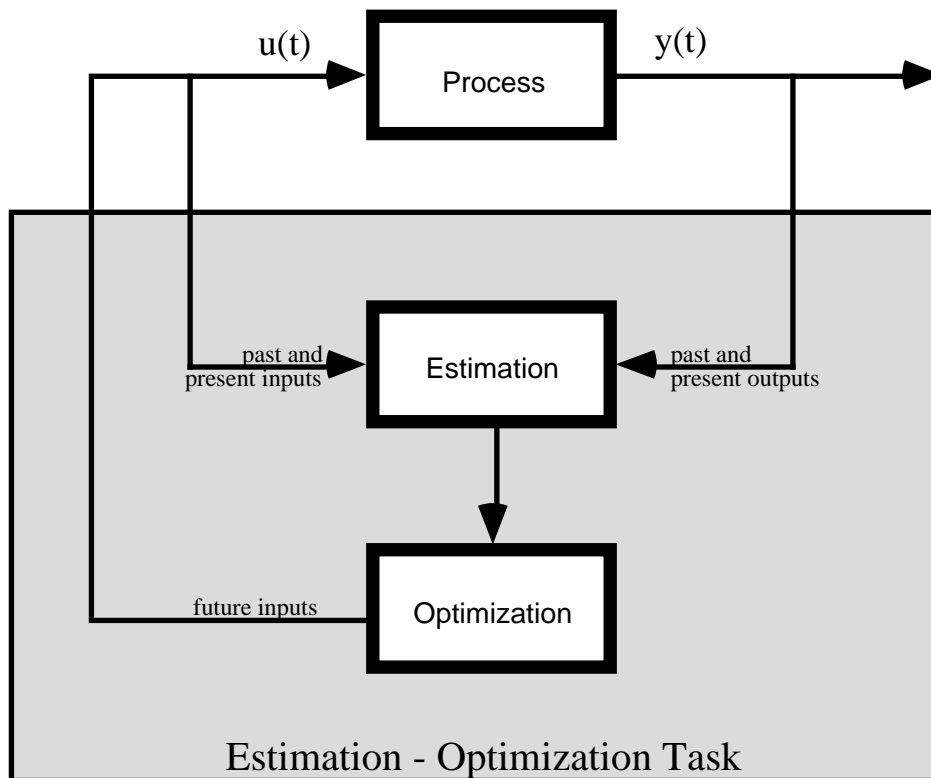

Fig. 8. The two-step approach to on-line optimization

Clearly, this is a 'closed-loop' scheme. Moreover, both the estimation and the optimization are based on a model which is usually nonlinear. In the estimation step, an optimal description (i.e. estimates of parameters and states) of the actual plant is chosen based on past measurements. The optimization step uses this model to compute an input profile that optimizes an objective function. Hence, the expressions *adaptive*, *model-based* or *predictive* could also be associated with this type of on-line optimization. Finally, on-line optimization correspond to

feedback control. The closed-loop scheme implies a feedback structure and, if the interval between two EOTs is small, resembles conventional feedback control.

An efficient method for solving nonlinear dynamic optimization problems was published by Tjoa and Biegler (1991). The control and state variables are parametrized, and the differential equations reduced to algebraic form using orthogonal collocation. The resulting algebraic optimization problem (AOP) is solved with an infeasible-path method.

The optimization strategy is here to perform several EOTs. An EOT consists of an estimation with SQP and a subsequent optimization with successive linear programming (SLP). Ruppen (1994) proposed a suitable optimization strategy for batch and semi-batch chemical processes.

3.3. Optimization problem

The optimization objective was defined as that of minimizing the reaction time while satisfying the five dynamic constraints representing the reactor model and the following three endtime specifications:

- a) A production of at least 0.42 mol PAA is desired:

$$c_{\text{PAA}}(t_f)V_R(t_f) \geq 0.42 \text{ mol} \quad (7a)$$

Pyrrole is an expensive compound. For $c_p(0)v_R(0)=0.72 \text{ mol}$, at least 58% of pyrrole needs to react to PAA for productivity reasons.

- b) The final concentration of DHA has to be below 0.15 mol l^{-1} :

$$c_{\text{DHA}}(t_f) \leq 0.15 \text{ mol l}^{-1} \quad (7b)$$

This is of practical interest since the solubility of DHA in the reaction mixture at the reaction temperature ($50 \text{ }^\circ\text{C}$) is about 0.2 mol l^{-1} . The solubility decreases when the reaction mixture cools down, and the maximal allowable value of 0.15 mol l^{-1} is imposed to prevent precipitation at room temperature.

- c) The final concentration of diketene has to be below 0.025 mol l^{-1} :

$$c_{\text{D}}(t_f) \leq 0.025 \text{ mol l}^{-1} \quad (7c)$$

Diketene is a highly toxic compound. Therefore, a small concentration is required to ease further handling of the reaction mixture.

Since the rate law of the dimerization reaction is of higher order in the concentration of diketene than that of the main reaction, the selectivity can be controlled by adjusting the feed rate of diketene to a given solution of pyrrole. The mathematical formulation of the optimization problem is given as follows:

$$\begin{aligned}
 & \min_{f(t)} t_f & (8) \\
 & \text{s.t.} \quad \text{dynamic equations} \\
 & \quad \quad \text{endpoint constraints} \quad (7) \\
 & \quad \quad f(t) \geq 0
 \end{aligned}$$

3.4. Optimization results

The feed profile is parametrized a priori as shown in Figure 9. The length and the level of the first interval ('reaction part') are mainly influenced by constraints (7a) and (7b) whereas those of the second interval ('safety part') by constraint (7c). The number of degrees of freedom for the optimization is four (f_1 , f_2 , t_{12} and t_f). Profiles with a larger number of degrees of freedom were found to give no significant improvement. At the optimum, the three endpoint constraints are fulfilled and f_2 is at its lower bound ($f_2=0$). Thus, there is no degree of freedom left at the optimum. Other reasonable profiles with a larger number of degrees of freedom gave no significant improvement in the objective function.

A graphical representation of the successive estimation and optimization tasks for Run 1 is given in Figures 10 to 12. The resulting on-line calculated feed profile is subsequently implemented in Run 2 as an open-loop, a priori-given feed profile. The results are presented in Figure 13.

The initial solutions for estimation and optimization were chosen highly infeasible. Once the on-line optimization had been completed, each EOT step was repeated using two different initial profiles and profiles based on the result of the previous EOT. The converged profiles were always identical within the tolerances. This does not prove global convergence of the applied algorithms, but it provides at least an additional robustness check. For this particular on-line optimization problem, the computational efficiency of the estimation and optimization algorithms was not important, because sampling and chemical analysis was the limiting task. However, the strategy used proved to be highly efficient and robust. SQP and SLP converged within a few iterations.

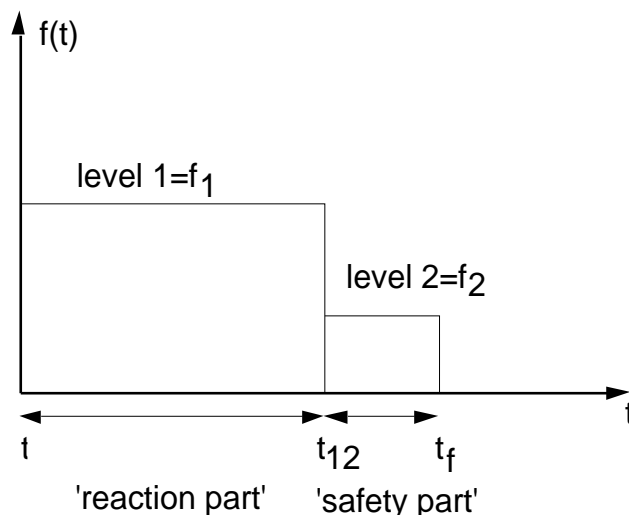
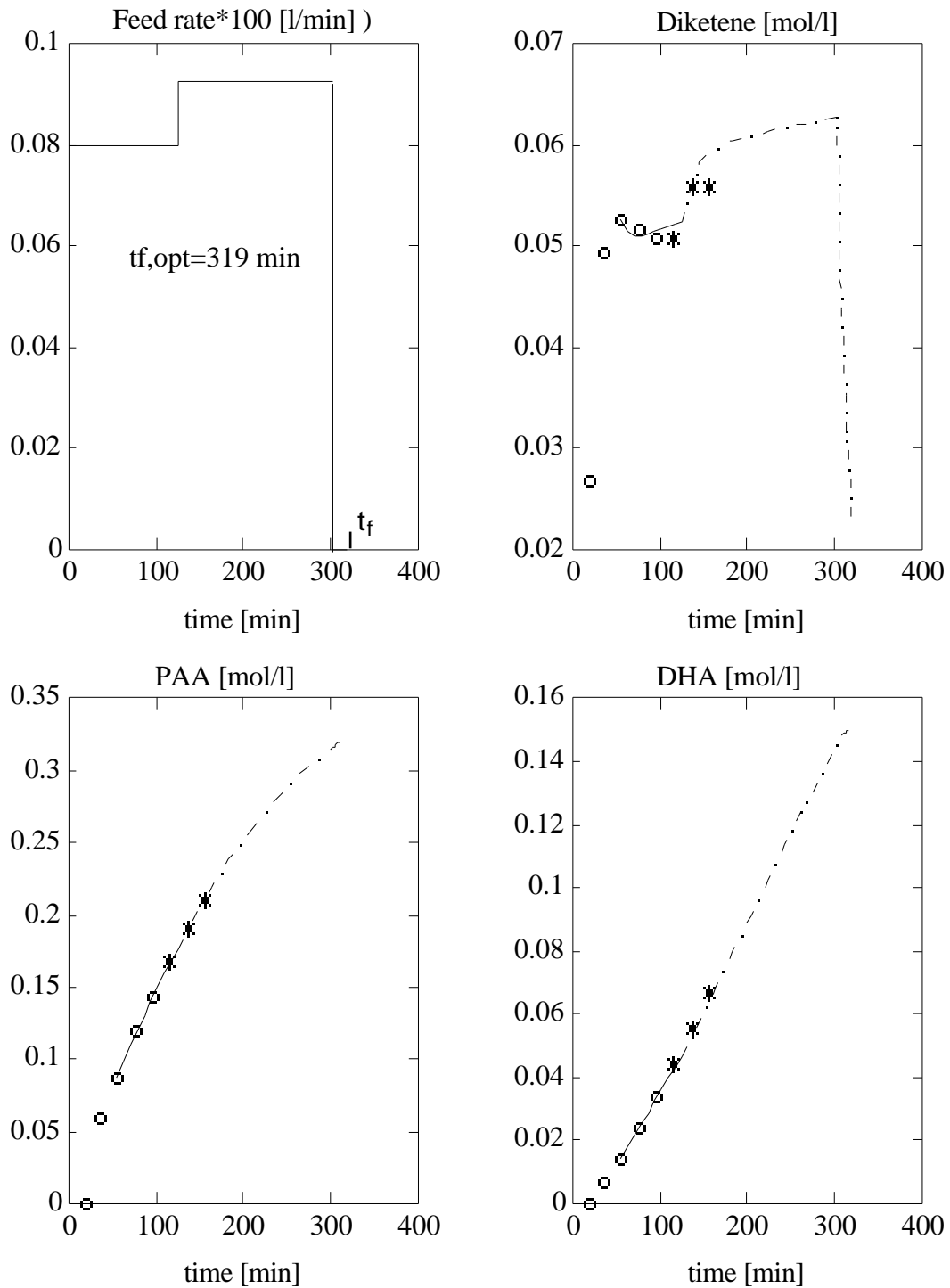
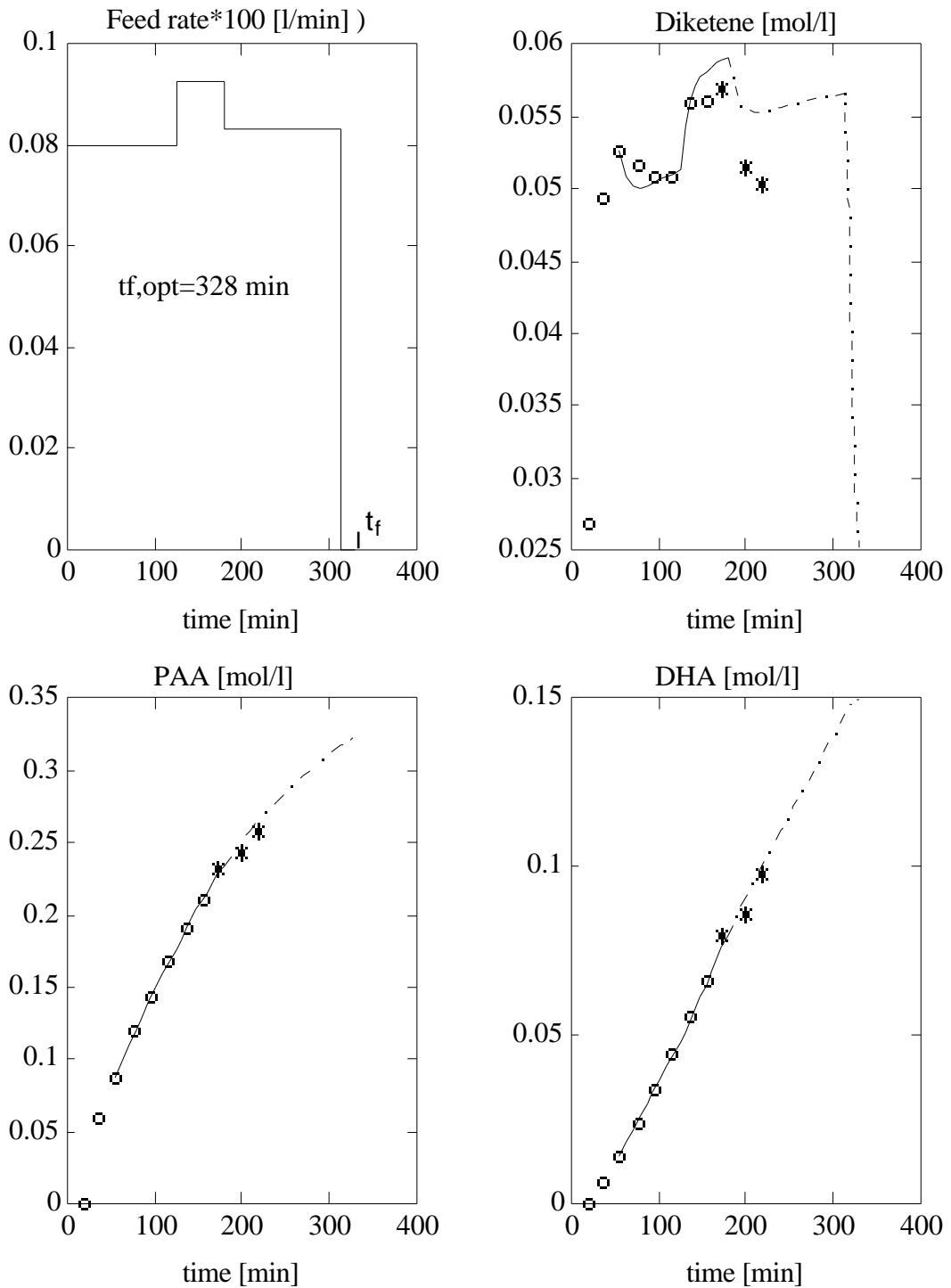

Fig. 9. Parametrization of the feed rate profile



Measurements are denoted by 'o'. EOT1 was performed after 124 min. using 3 measurements ($t_{0,est}=56$ min., $t_{f,opt}=124$ min.). Solid lines represent the estimated profiles and dash-dotted lines the predicted profiles from the optimization. The optimization proposed an increase in the feed rate. Optimal final batch time was predicted to be 319 min.

Fig. 10. Results of EOT1 after 124 min. using 2 measurements and checked with 3 additional measurements ('*')



Due to the acceleration in formation of DHA, the second optimization proposed a lower feed rate. The predicted optimal batch time increased from 319 min to 328 min.

Fig. 11. Results of EOT2 after 179 min. using 5 measurements and checked with 3 additional measurements ('*')

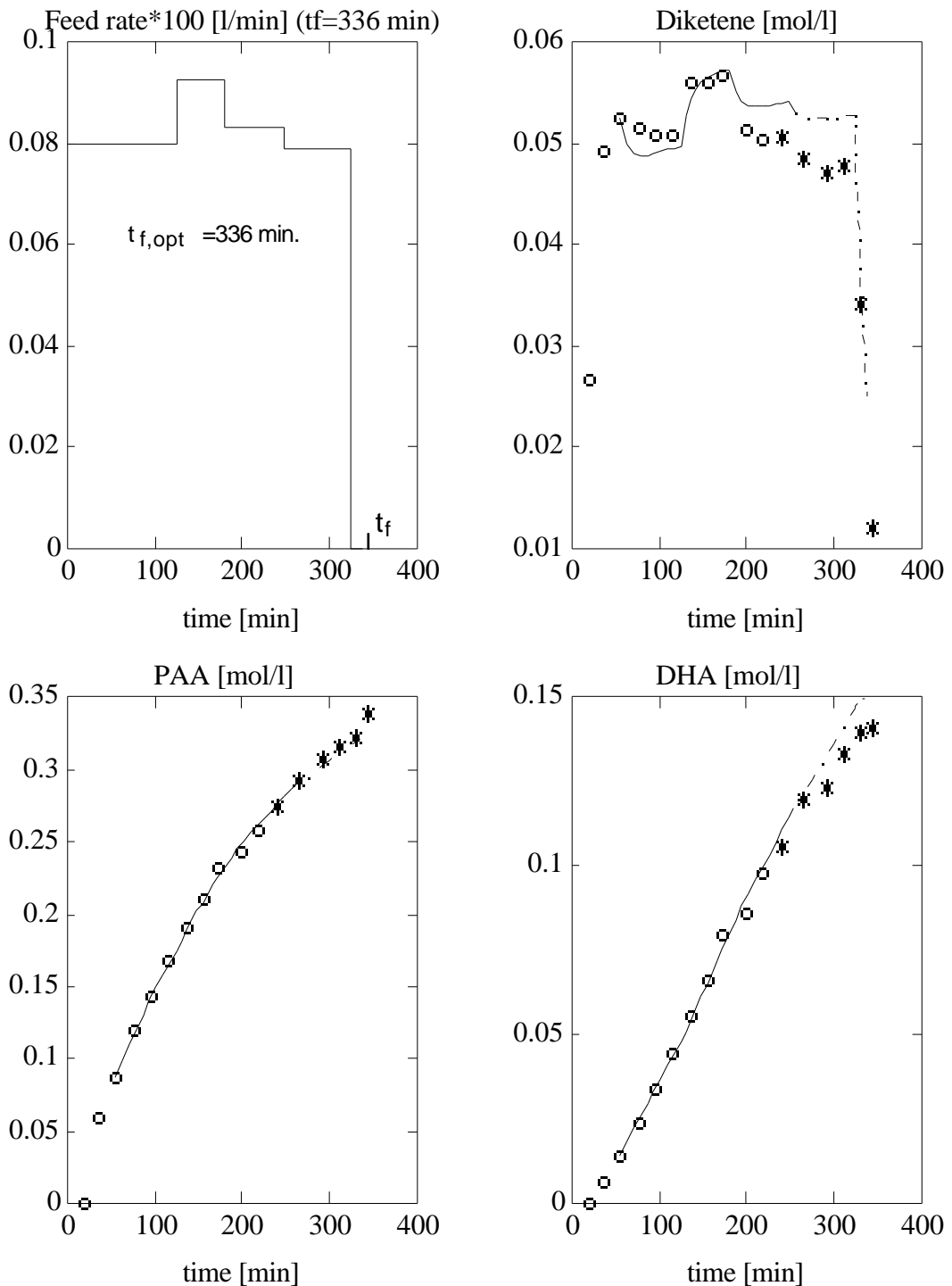

The optimization proposes a still lower feed rate and predicts a slightly larger optimal batch time. The operator decides to perform no additional EOT and finishes the batch as proposed by EOT3. The relative deviations in the endpoint constraints are: $\text{yield}(t_f) +5 \%$ (no violation), $c_{DHA}(t_f) -6 \%$ (no violation), $c_D(t_f) -50 \%$ (no violation).

Fig. 12. Results of EOT3 after 248 min. using 8 measurements and checked with 6 additional measurements ('*')

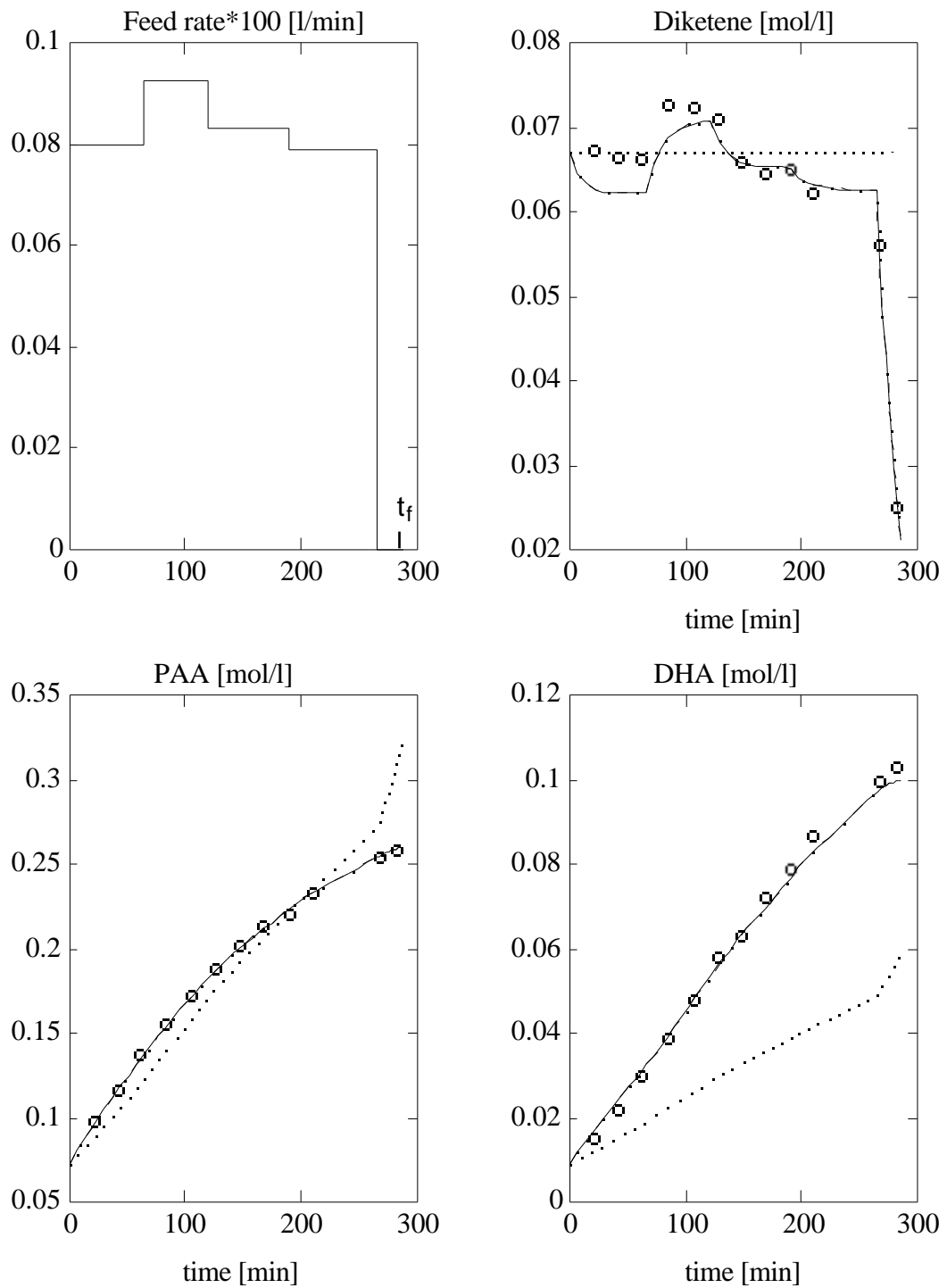

Open-loop, a priori-given feed profile (feed rate from closed-loop optimization of Run 1). Here, the initial time 0 corresponds to $t_{0,est}$ and not to the initial time of the experiment. In contrast to Run 1 there was no DHA-promoter present and a smaller amount of pyridine was used. The relative deviations in the endpoint constraints are: yield(t_f) -18% (**serious** violation), $c_{DHA}(t_f)$ -31 % (no viol.), $c_D(t_f)$ 0 % (no viol.)

Fig. 13. Initial (····) and converged (—) profiles for the estimation using the entire data of Run 2

4. Conclusions

These two real-life examples have shown that it is possible to improve the operation of dynamic processes using distinct approaches.

The traditional way consists of carefully modeling the process and of using optimization techniques to determine optimal values for the input variables. Because of model mismatch and incomplete measurement, such an approach usually requires parameter and/or state estimation to be of any use in a realistic industrial environment. Furthermore, this approach, which was used for determining the optimal operation of the semi-batch reactor, is quite demanding with respect to both development time and on-line computational effort.

In the case of the fixed-bed bioreactor, (near) optimal operation was obtained using an appropriate feedback strategy. This approach, which is not model based, was made possible by the monotonicity property of the objective function with respect to certain variables. Although it is difficult to verify the necessary monotonicity properties with realistic industrial systems (such an investigation would clearly require a detailed process model), these properties are often present to a large extent. As a result, practitioners have successfully implemented near-optimal operation by forcing their processes to run at or close to available or imposed constraints

Acknowledgment

The author would like to thank his two collaborators, Christina Benthack (presently with the EPFL in Lausanne) and Dr David Ruppen (formerly with the ETH in Zürich and presently with Lonza AG in Visp) for their insight in the field of process optimization and their help in preparing this article.

References

- Agarwal, M. and D. Bonvin. *Limitations of the Extended Kalman Filter for Batch Reactors*. IFAC Symposium DYCORN+, Maastricht (1989).
- Benthack, C., B. Srinivasan and D. Bonvin. *Optimal Operation Modes for a Fixed-bed Bioreactor Used in Wastewater Treatment*. IFAC World Congress, San Francisco (1996).
- Bryson, A.E. and Y.-C. Ho. *Applied Optimal Control*. Ginn and Company (1969).
- De Vallière, P.R.L. *State and Parameter Estimation in Batch Reactors for the Purpose of Inferring On-line the Rate of Heat Production*. ETH Diss. N° 8847 (1989).
- Grady, C.P.L. and H.C. Lim. *Biological Wastewater Treatment, Theory & Applications*. Marcel Dekker. New York (1980).
- Pujol, R., M. Hamon, X. Kandel and H. Lemmel. *Biofilters : Flexible, Reliable Biological Reactors*. Proceedings of the IAWQ International Specialized Conference on Biofilm Reactors, Paris, pp. 69-76 (1993).
- Ruppen, D. *A Theoretical and Experimental Contribution to the Implementation of Adaptive Optimal Operation for Discontinuous Chemical Reactors*. ETH Diss. N° 10634 (1994).
- Tjoa, I.-B., Biegler L.T. *Simultaneous Solution and Optimization Strategies for Parameter Estimation of Differential-Algebraic Equation Systems*. Ind. Eng. Chem. Res., 30, 376-385 (1991).