

Encounters at the end of time
The farewell spaces reconsidered
Sion | St. Francois
New Cemetery

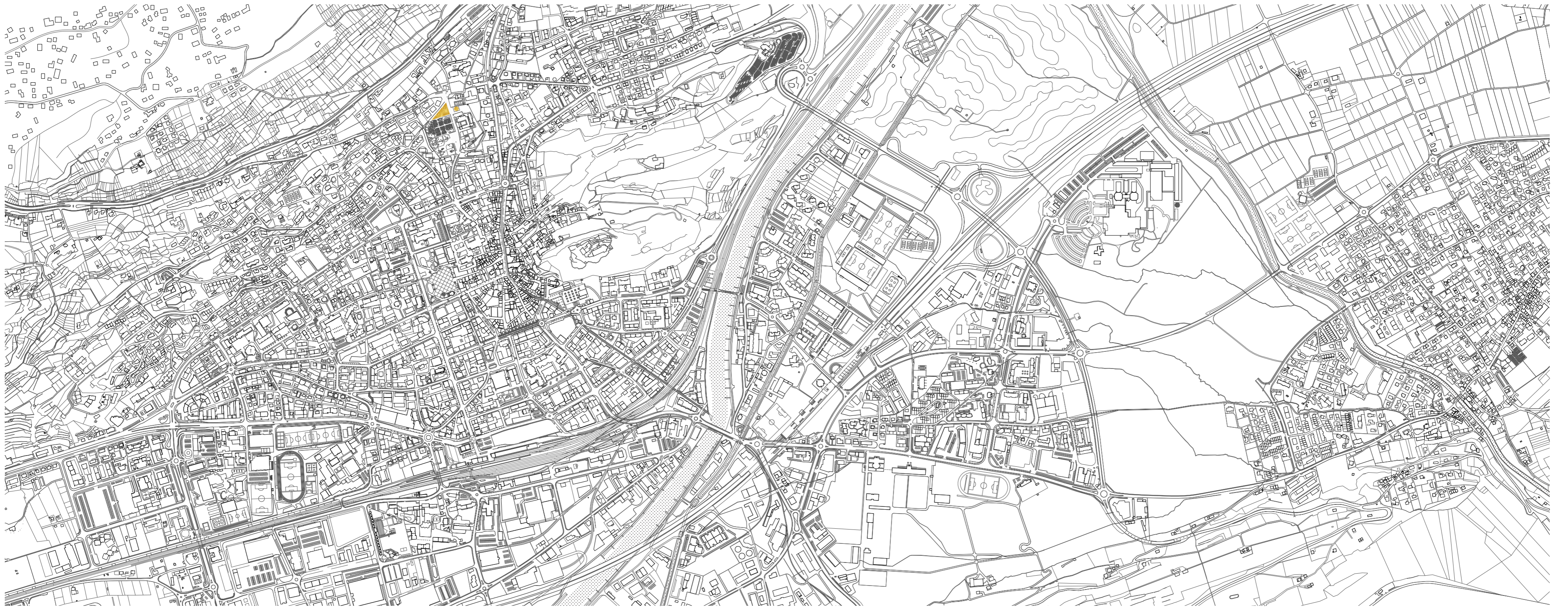

0 100 200



0 5 20

Encounters at the end of time
The farewell spaces reconsidered
Sion | St. Francois
City 1:10000 | Situation 1:500

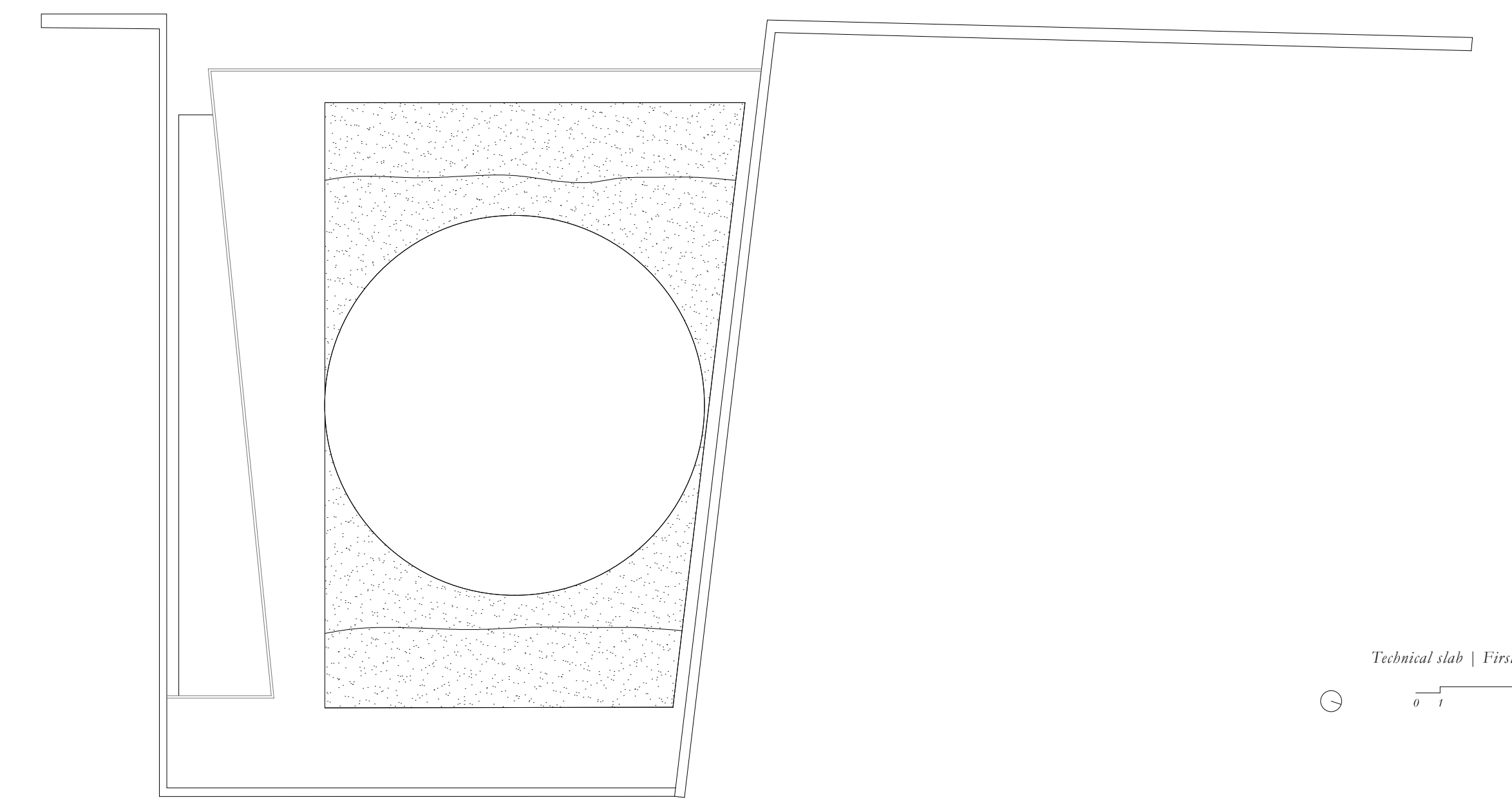
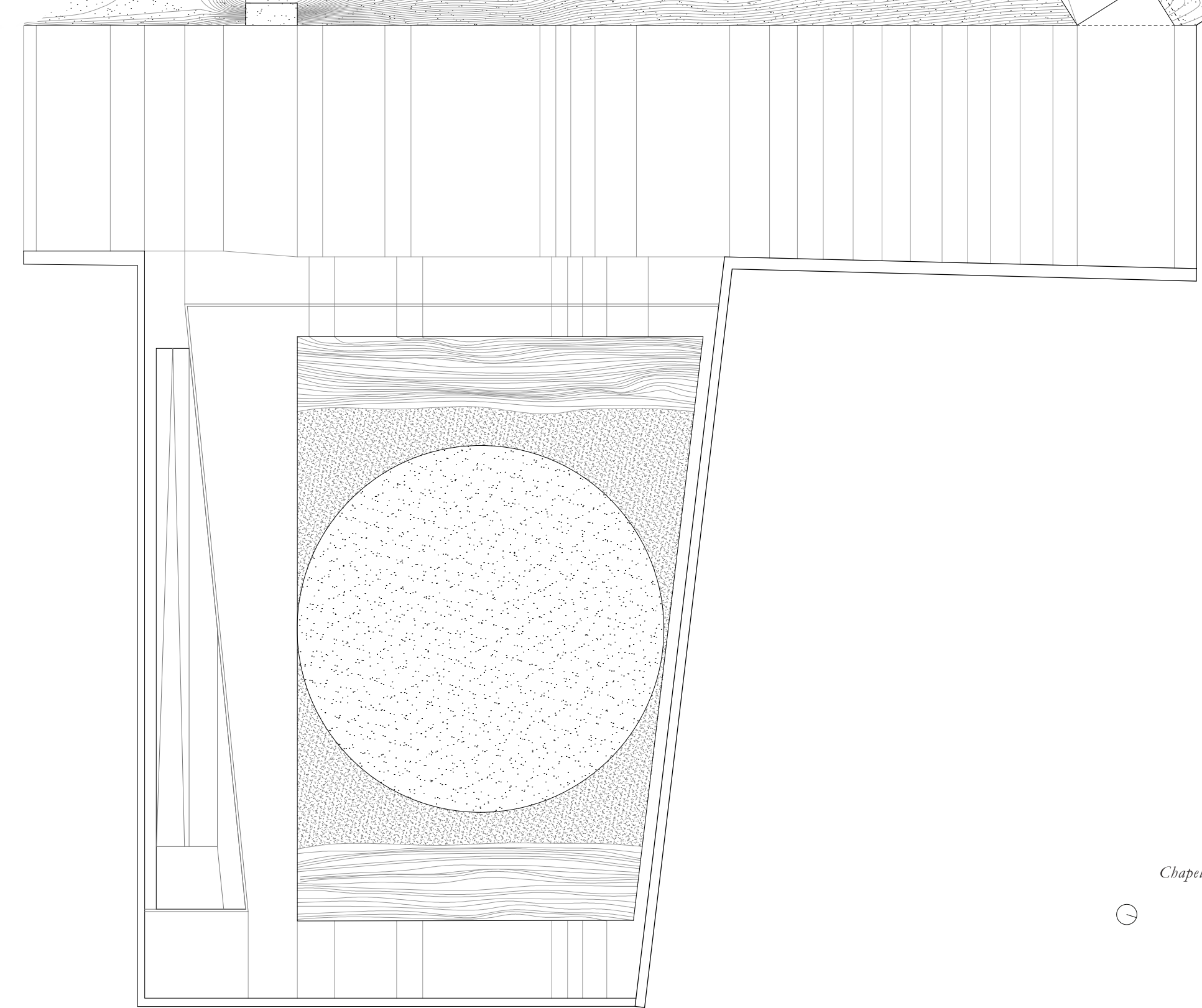
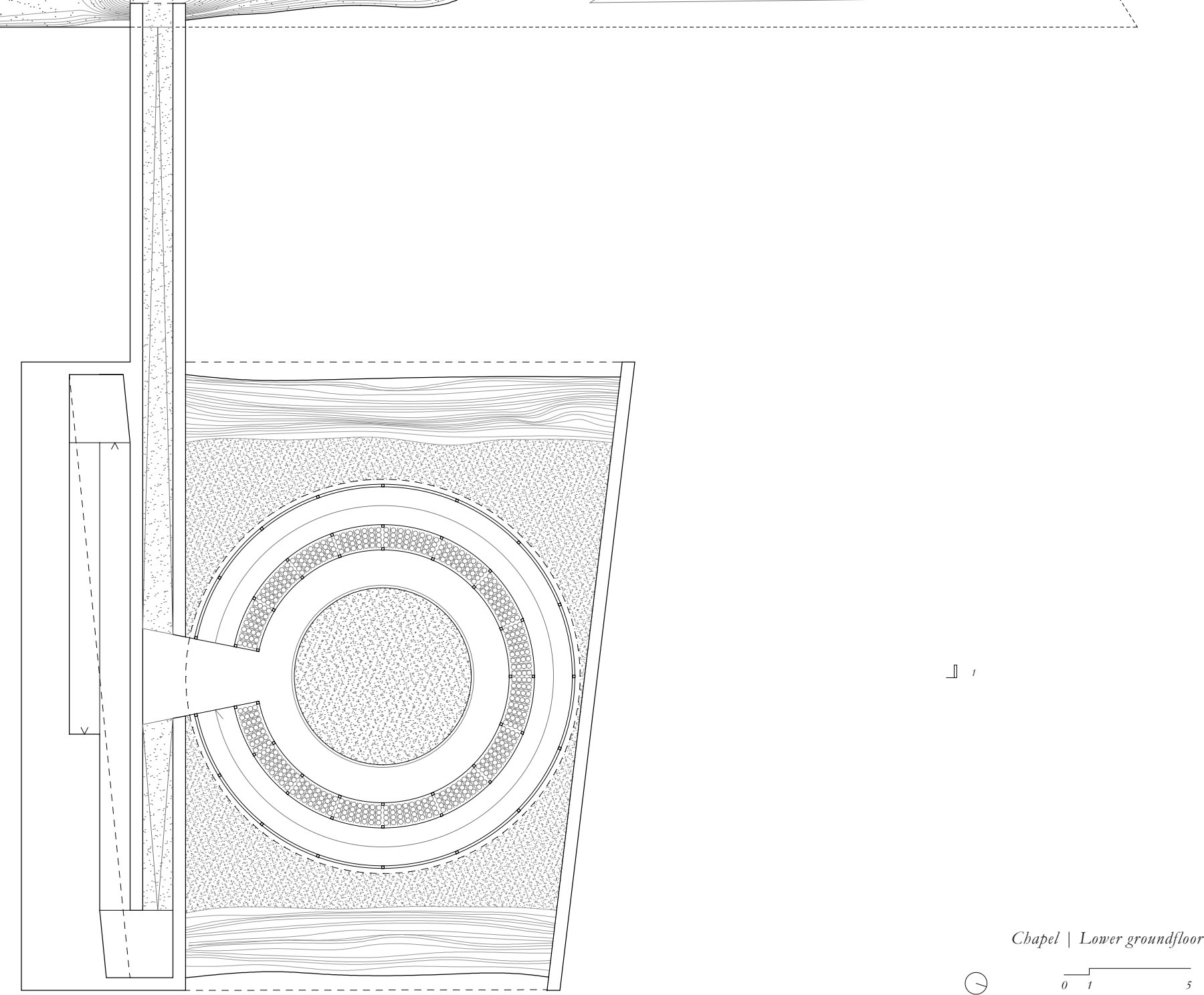
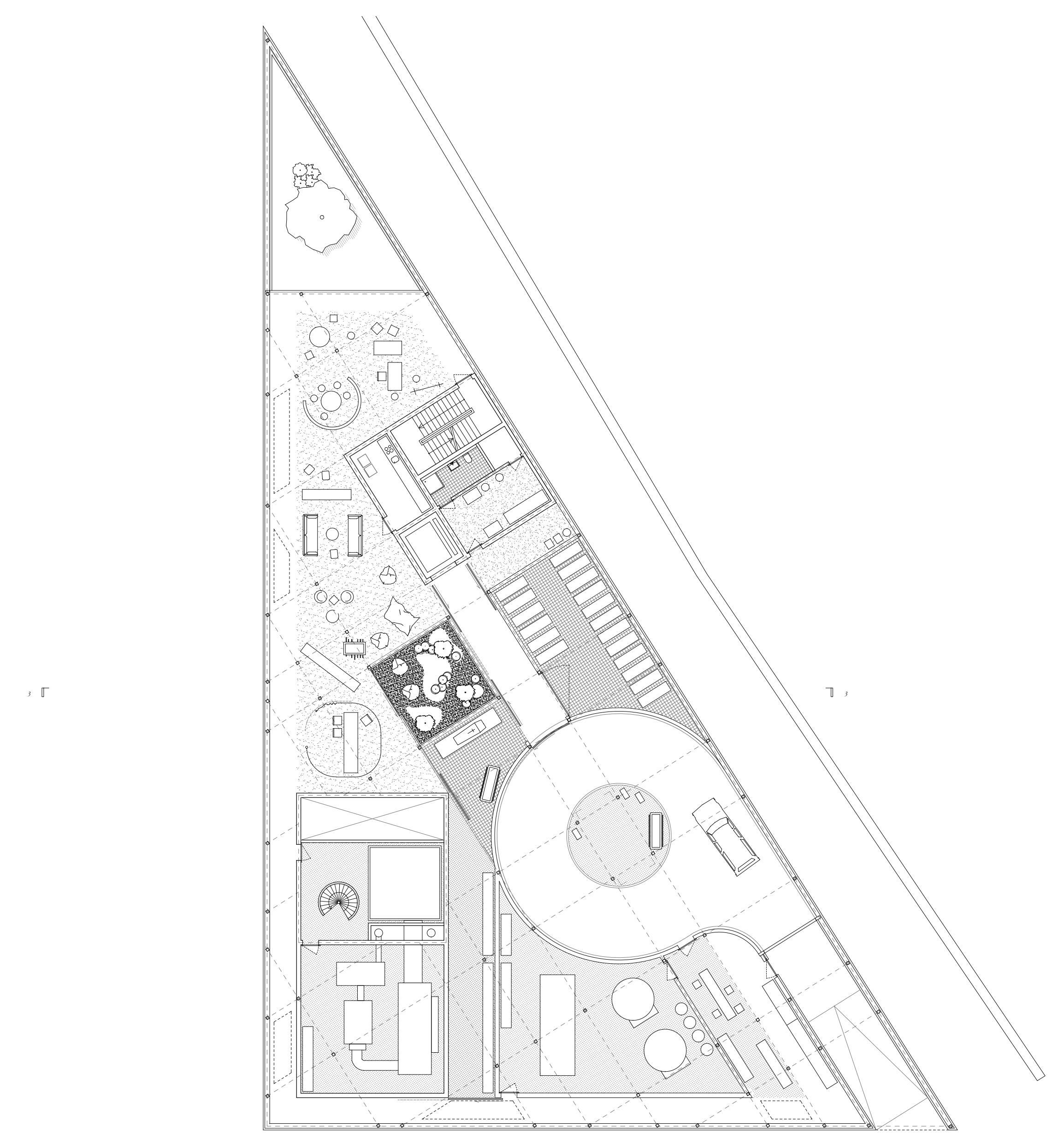
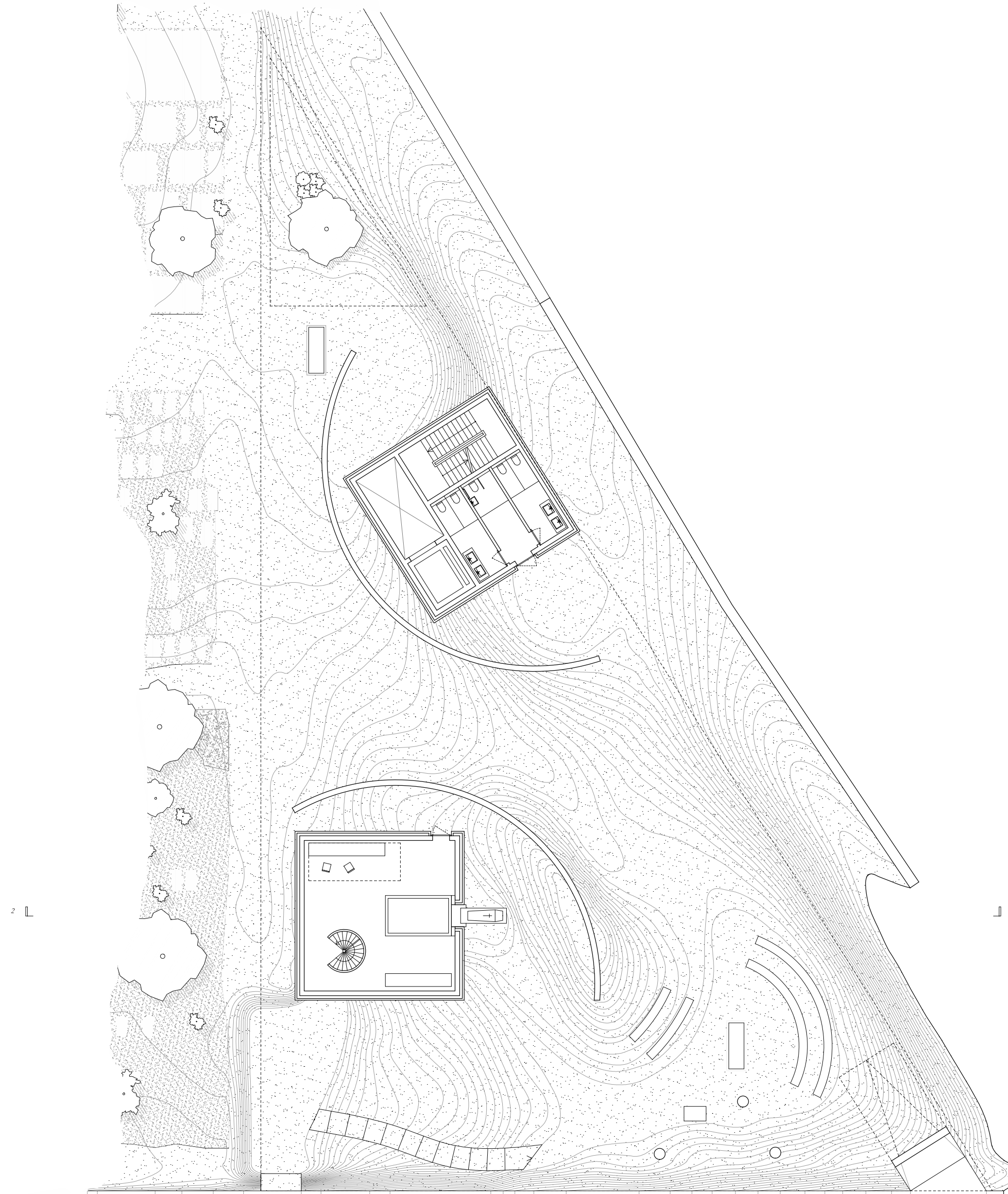
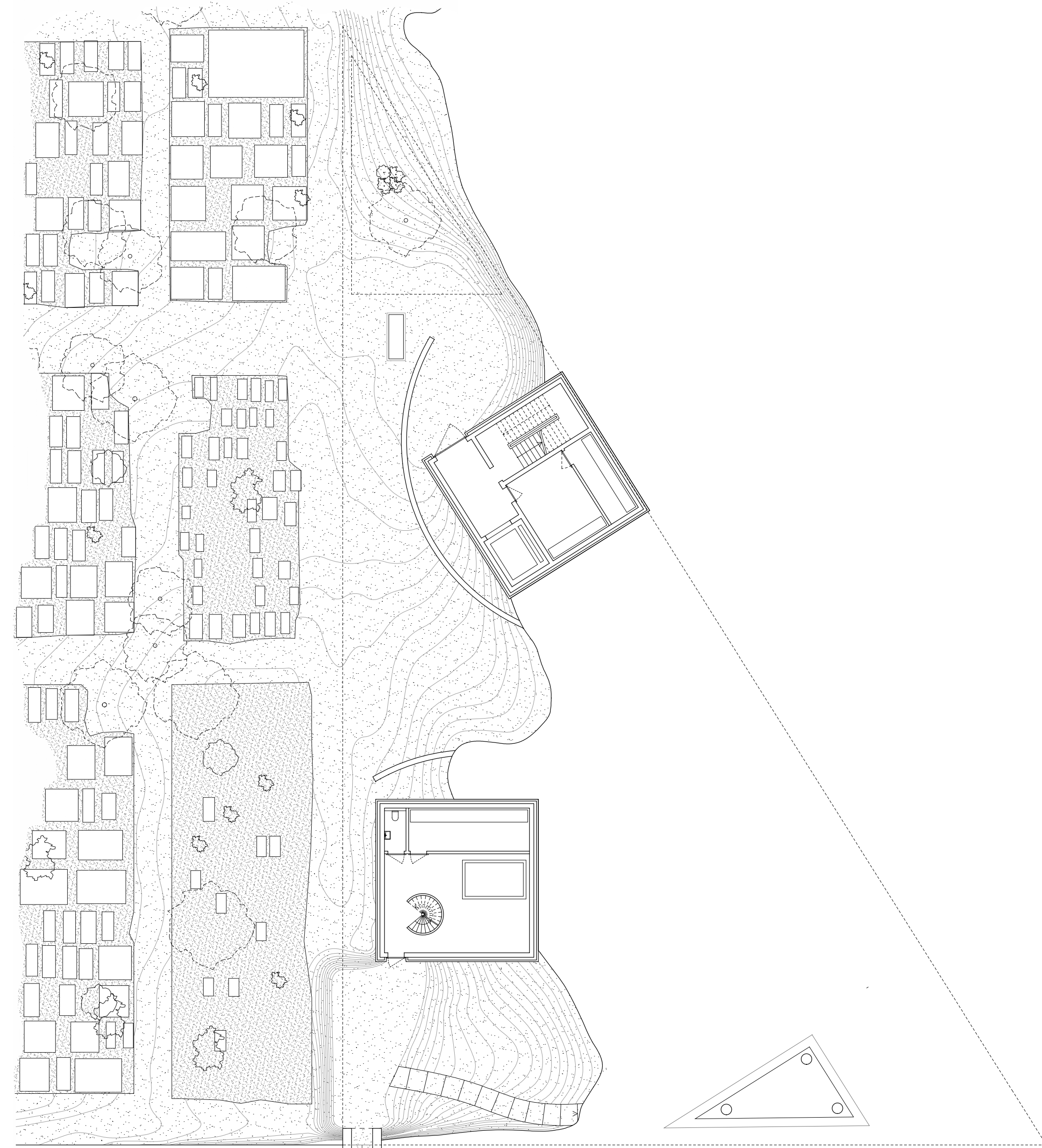
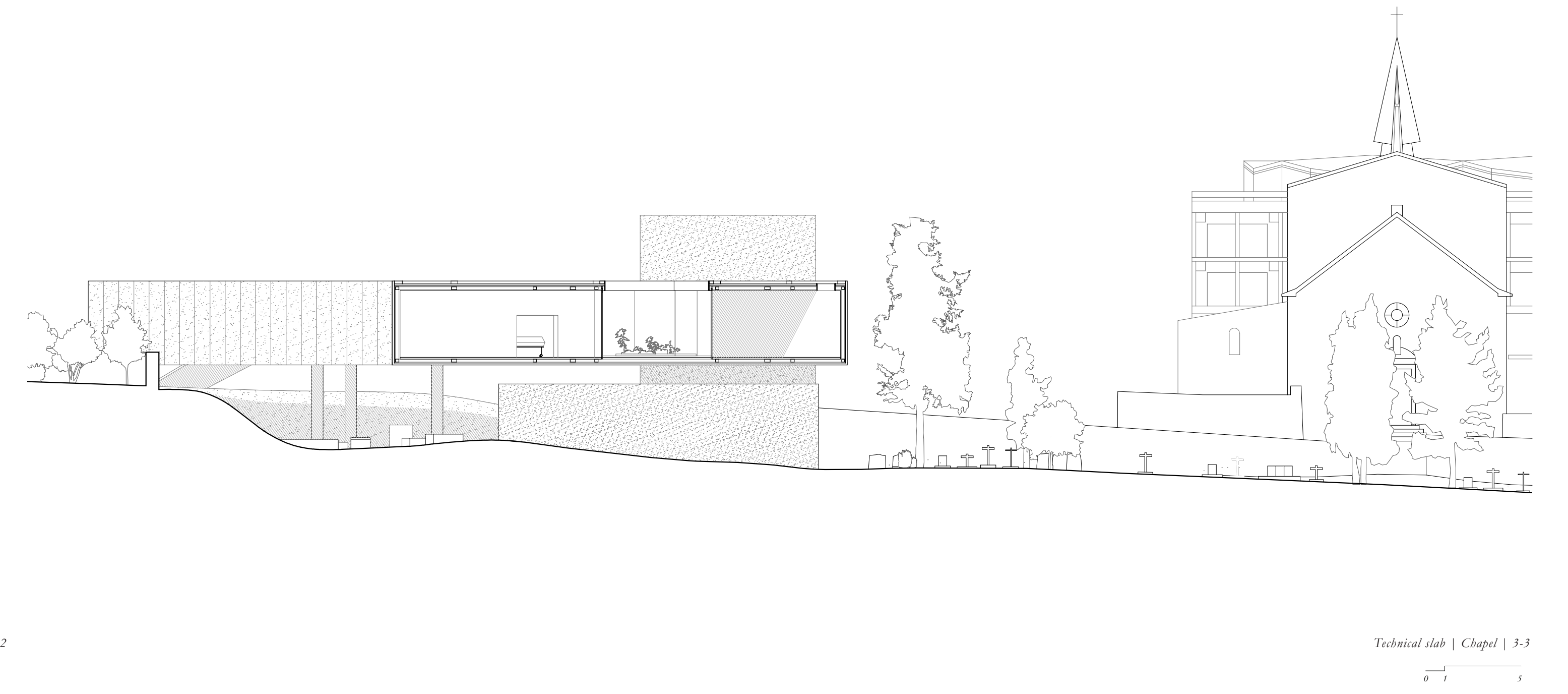
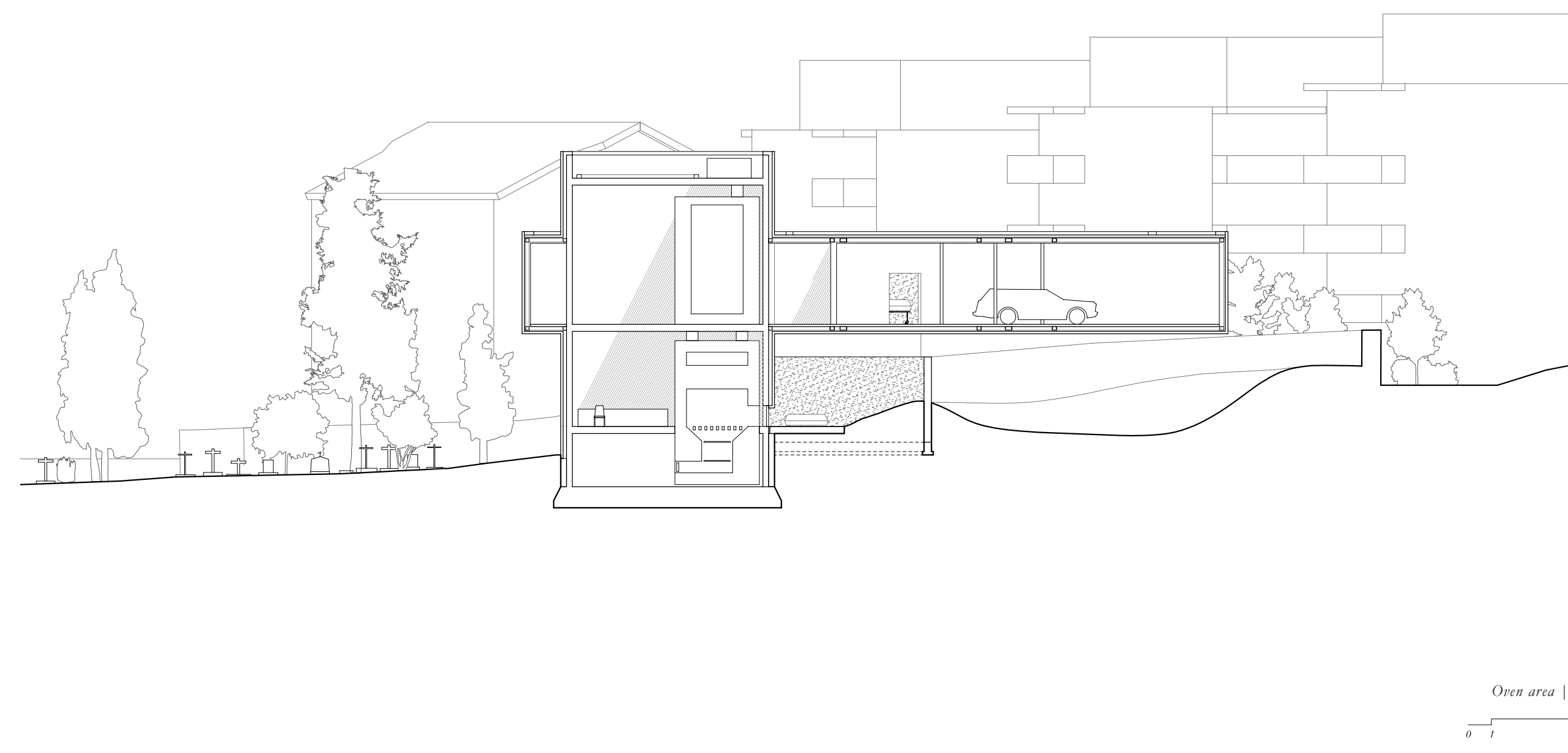
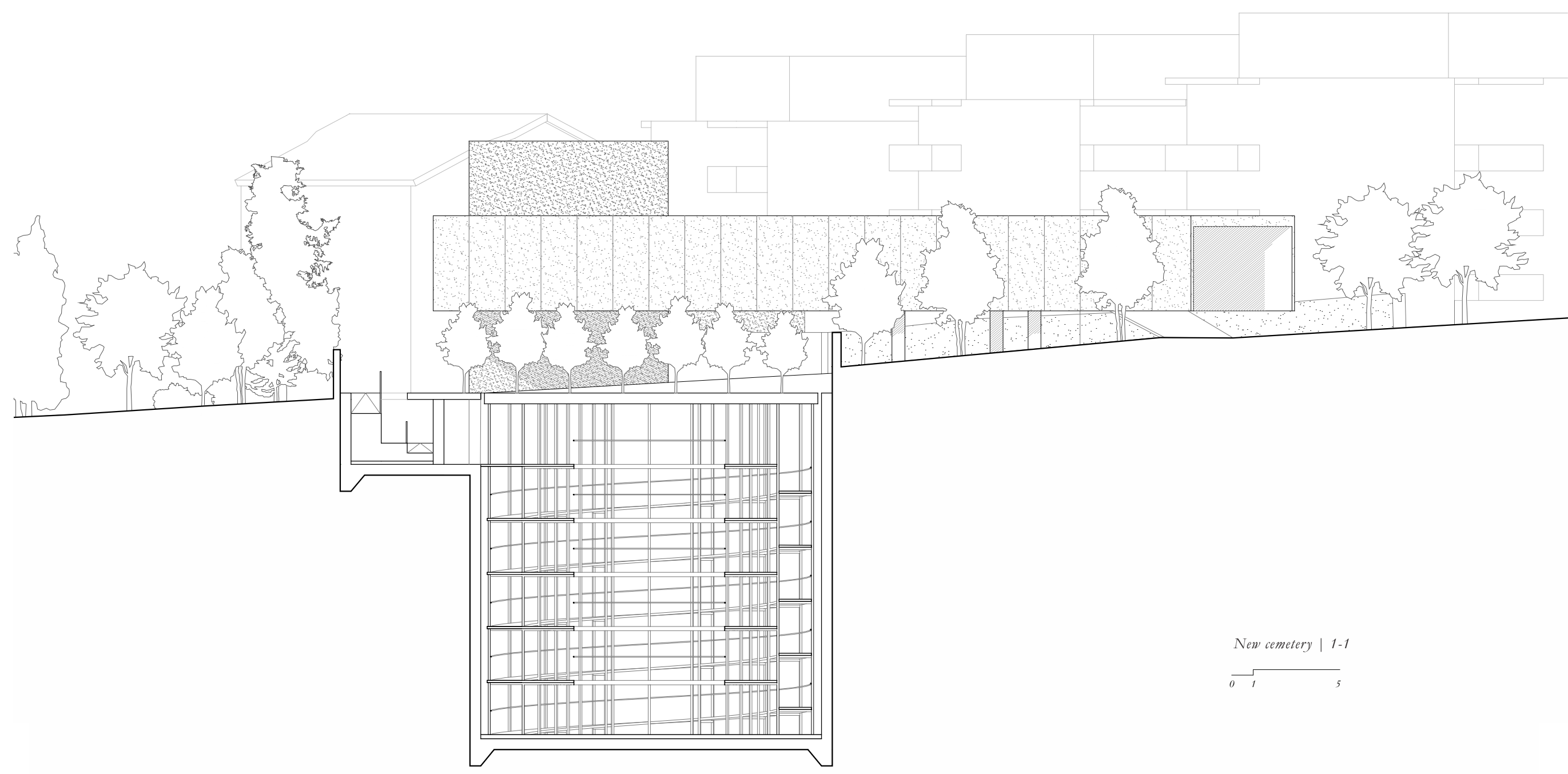

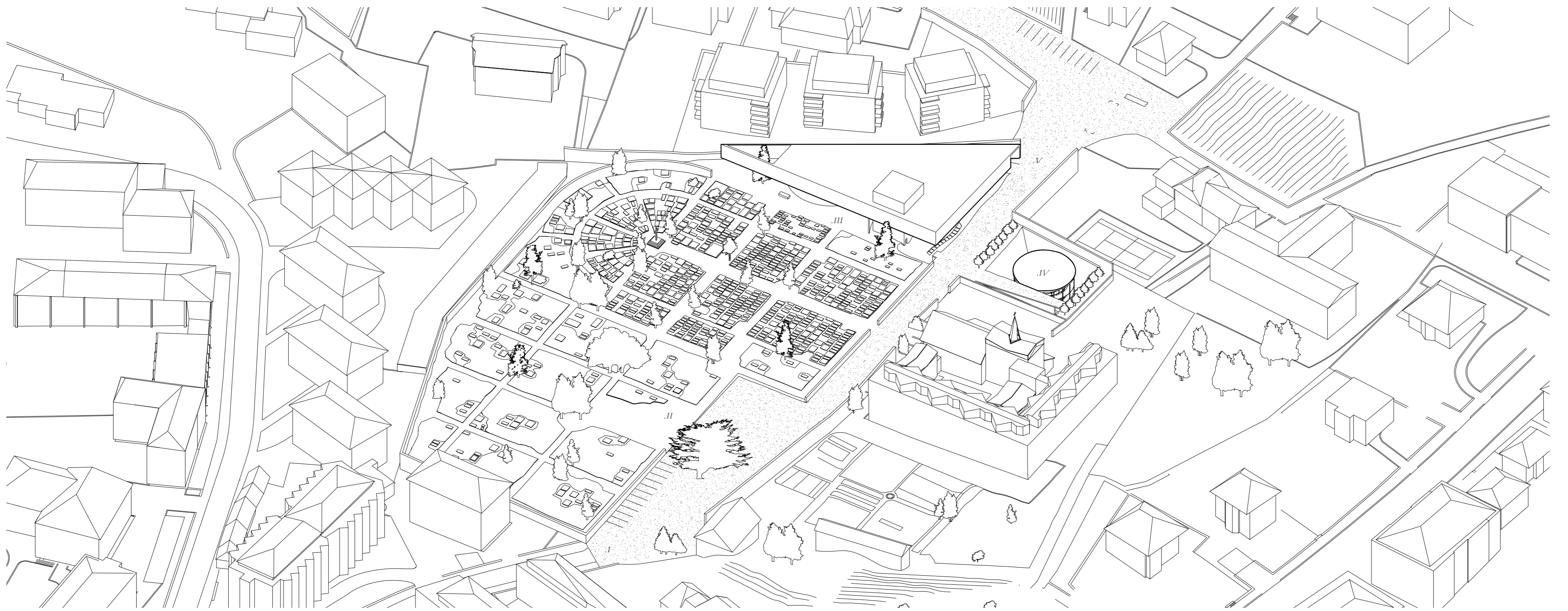

- I. Connexion with the Old Town
- II. Park entrance | Public square
- III. Canopy access
- IV. Columbarium
- V. Back entrance

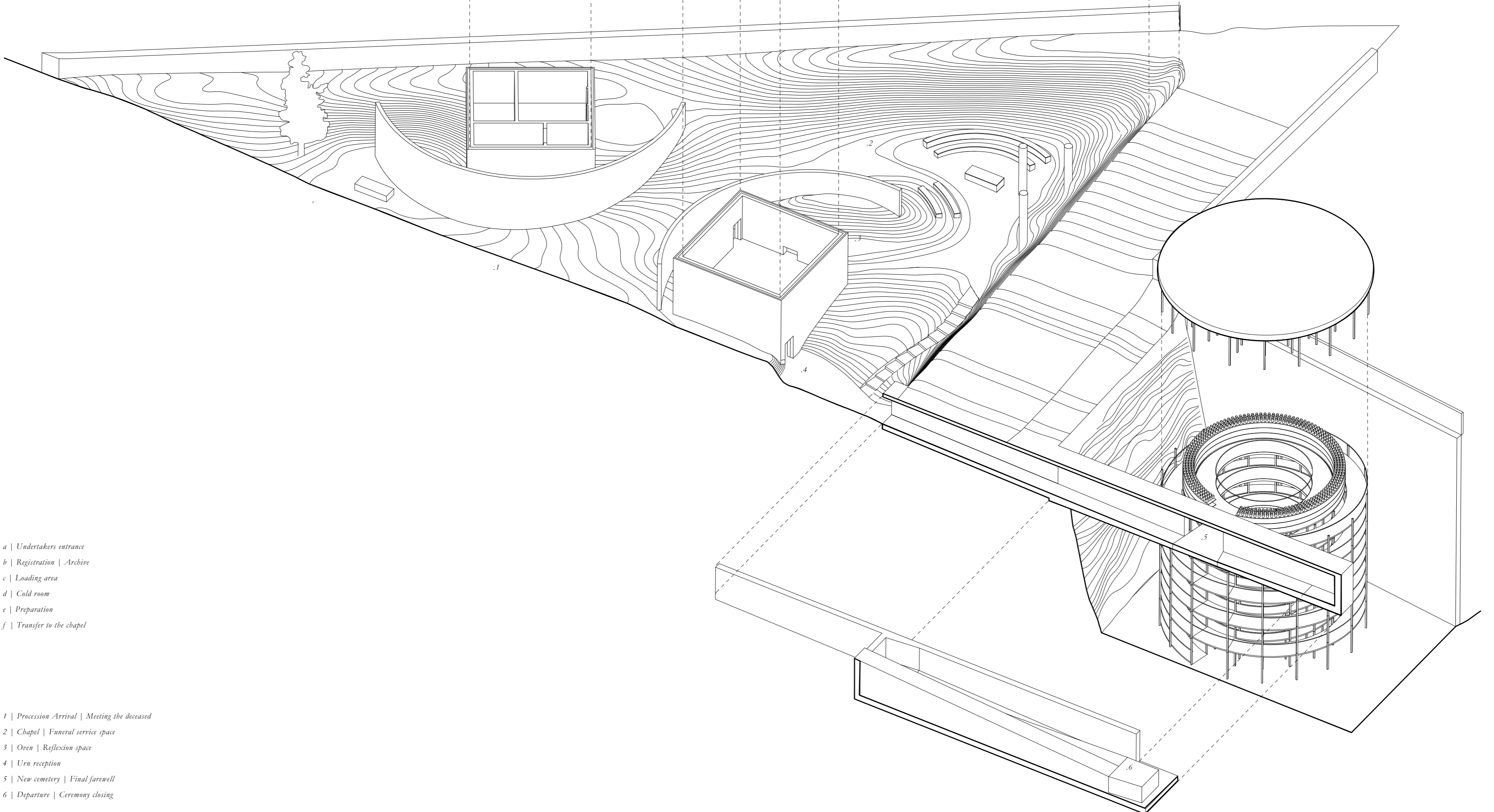
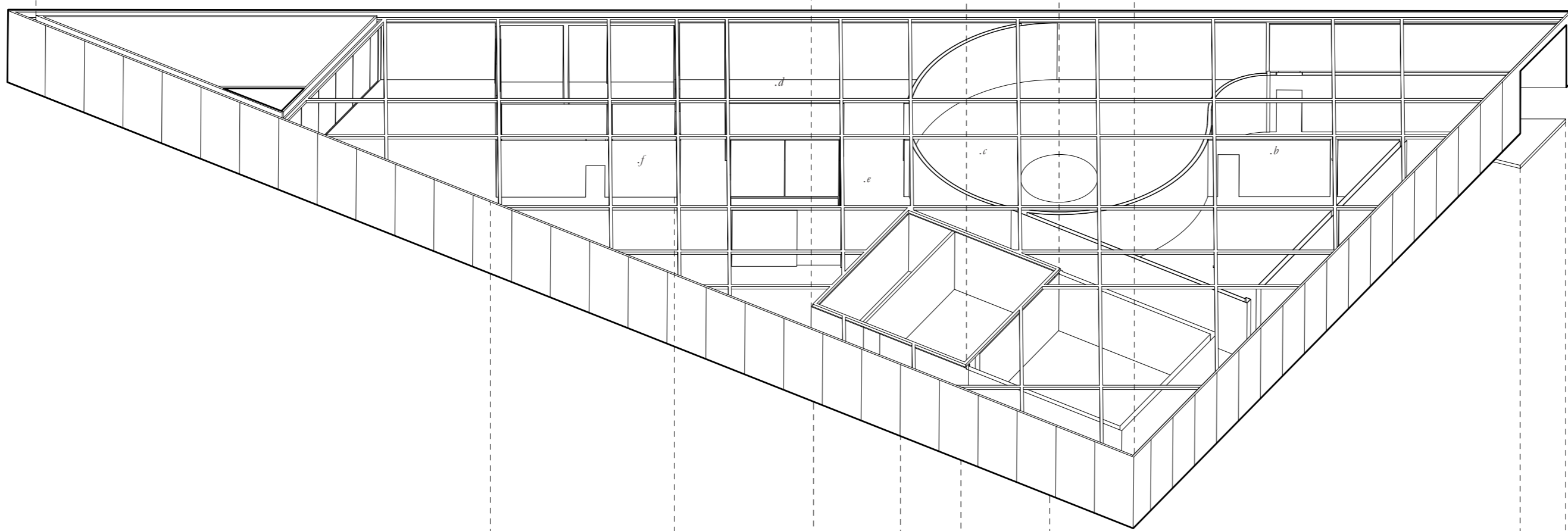
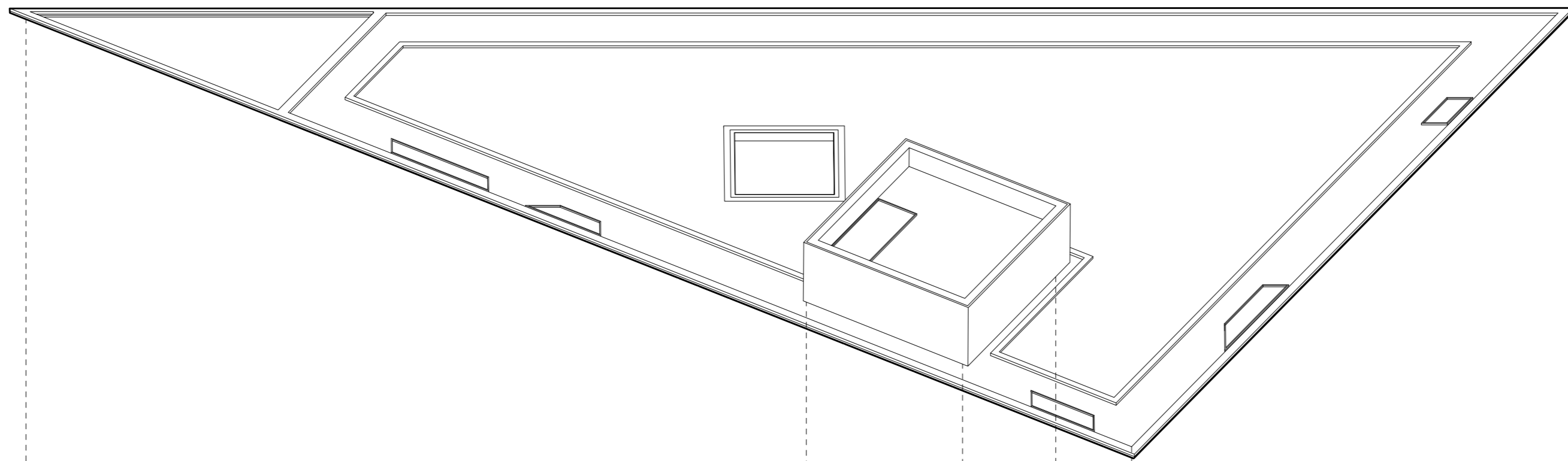

- a | Undertakers entrance
- b | Registration | Archive
- c | Loading area
- d | Cold room
- e | Preparation
- f | Transfer to the chapel

- 1 | Procession Arrival | Meeting the deceased
- 2 | Chapel | Funeral service space
- 3 | Open | Reflection space
- 4 | Urn reception
- 5 | New cemetery | Final farewell
- 6 | Departure | Ceremony closing