

# **Supernumerary Robotic Arm for Three-Handed Surgical Application: Behavioral Study and Design of Human-Machine Interface**

THÈSE N° 7343 (2017)

PRÉSENTÉE LE 27 JANVIER 2017

À LA FACULTÉ DES SCIENCES ET TECHNIQUES DE L'INGÉNIEUR  
LABORATOIRE DE SYSTÈMES ROBOTIQUES  
PROGRAMME DOCTORAL EN ROBOTIQUE, CONTRÔLE ET SYSTÈMES INTELLIGENTS

ÉCOLE POLYTECHNIQUE FÉDÉRALE DE LAUSANNE

POUR L'OBTENTION DU GRADE DE DOCTEUR ÈS SCIENCES

PAR

**Elahe ABDI**

acceptée sur proposition du jury:

Prof. A. Ijspeert, président du jury  
Prof. H. Bleuler, Dr M. Bouri, directeurs de thèse  
Prof. E. Burdet, rapporteur  
Dr S. Himidan, rapporteuse  
Prof. O. Blanke, rapporteur



ÉCOLE POLYTECHNIQUE  
FÉDÉRALE DE LAUSANNE

Suisse  
2017



To my parents with all my love...



# Acknowledgements

My first and foremost gratitude goes to my thesis supervisors Prof. Hannes Bleuler and Dr. Mohamed Bouri who provided me with the opportunity of pursuing my Ph.D. thesis at the Laboratoire de Systèmes Robotiques (LSRO) at EPFL. Their supervision was a combination of invaluable guidance, excellent support, scientific enthusiasm as well as trust and freedom making the Ph.D. period a valuable experience. It has been a true honor to work with them during the past few years.

My sincere gratitude goes to the members of my jury Prof. Auke Ijspeert, Prof. Olaf Blanke, Prof. Etienne Burdet and Dr. Sharifa Himidan for their encouraging and insightful comments. I am in particular thankful to Prof. Burdet for his brilliant ideas and detailed critiques all through my Ph.D. studies. I am also thankful to Dr. Himidan for the priceless opportunity of being in direct contact with surgeons and performing experiments in the Hospital of SickKids, Toronto, Canada.

I would like to address my heartfelt thanks to Prof. Morel and Dr. Azagury from the Hôpitaux Universitaires de Genève (HUG) who enhanced the firsthand observation of different surgical procedures in the early stages of my research. I am also grateful to all the members of the mechanical workshop, especially Marc Jeanneret, Laurent Chevalley and Marc Salle for their invaluable manufacturing advices and the friendly atmosphere.

My time at LSRO was made enjoyable by an amicable and regenerative environment across the years created by my colleagues in the laboratory. Tremendous thanks to all of them for the friendly atmosphere and the priceless moments: David, Ali, Lionel, Ricardo, Solaiman, Laura, Simon, Silvia, Giulio, Jeremy, Amalric, Jemina, Tristan, Romain, Luzius, Philipp, Laurent and Atena. It was an unforgettable experience to work with you all.

During my stay in Lausanne, I was fortunate to meet many wonderful people and make lifelong friends. Here I would like to thank some of them for their friendship, kindness and support through the past years: Leili, Fatemeh, Arizu, Majid, Sina, Mina, Sina, Mohammad, Mostafa, Maryam, Masoumeh, Ali, Mahdi.

I am thankful to my especial friends whose support and friendship have been with me for long years despite the long distance between us. Thank you Samira and Sara for your warmth, sincerity and presence.

Many thanks to Reza for his love, great patience and kindness, and exceptional understanding. This journey wouldn't have been possible without his constant encouragement and inspiration.

Last but not least, my deepest and forever thanks to my beloved parents for their endless love and support, their infinite patience and compassion. They are the source of hope and happiness in my life. I wish to express my heartfelt thanks to my brother and sister-in-law, Mohammad and Niloofar, for being an important part of my life. This thesis is dedicated to them.

*Lausanne, November 2016*

Elahe A.

# Abstract

In many surgical and industrial tasks, the operator often needs more than two hands, thus skillful assistance. Although human assistance can be appropriate, teamwork often is the source of errors and inefficiency, especially if the assistant is a novice or has never worked with the main operator. Furthermore, the need for assistance may become problematic in case of lack of human resources. For example the lack of personnel in the emergency service during night may have fatal consequences e.g. for some patients affected by an appendicitis. Our objective is to improve the surgeon's autonomy and possibly dexterity by providing him control over a robotic arm that can be used together with the natural arm.

Although a number of robotic instrument holders have been developed especially for surgical applications, the best way to control such devices is still an open question. No behavioral study has been conducted on the best control strategy and human performance in three-handed tasks, which is the goal of this thesis. We have selected the foot for commanding the third arm on the basis of a literature review. A series of experiments in virtual environments has been conducted to study the feasibility of the resulting three hands control.

The first experiment compares performance to catch objects falling in virtual environment using two or three hands. The results demonstrate that three-handed manipulation is preferred to two-handed manipulation in demanding tasks. Less effort was spent in the most demanding phase when performed with three than two hands. The second experiment investigated the type of tasks to be aimed in three-handed manipulation and the learning curve of users. Moving the hands and a foot simultaneously in opposite directions was perceived as difficult compared to a more active task with freedom in choosing the limbs coordination. Limbs were moved in parallel rather than serially and they were used with similar degree of priority. The

performance improved within a few minutes of practice showing a better performance in the second trial compared to the first one. Also, the sense of ownership improved constantly during the experiment.

Two other experiments, implemented in a virtual environment, were aimed at handling the laparoscopic endoscope. Surgeons and medical students participated in these studies. Residents had a more positive approach towards foot usage and performed better compared to more experienced surgeons. This proves that the best training period for surgeons to use a foot controlled robotic arm is during their residency. A realistic virtual abdominal cavity was developed for the last experiment. This had a positive influence on the participants' performance and emphasizes the importance of using a familiar context for training such "three-handed surgery".

Finally, two different foot interfaces were designed and developed in order to investigate an intuitive third arm commanding strategy. A robotic arm was controlled either by foot's translation/rotation in the isotonic interface, and by force/torque in the isometric interface. An experimental behavioral study similar to a laparoscopic surgery task was conducted to compare the two devices. Isometric rate control was preferred to isotonic position control due to the lower physical burden and higher movement accuracy of the robot. It was shown that the proposed device for isometric rate control could be used for intuitive control of four DoFs of a slave robotic arm.

This thesis provided a first step into a systematic investigation of a three-handed manipulation, two biological hands and a foot controlled robotic assistant. The findings suggest a high potential in using the foot to control a third (robotic) arm for becoming more autonomous in surgery and other fields. Users of this system can learn the control paradigm in a short period of time with little mental and physical burden. We expect the proposed foot interfaces to be the basis of future development of more intuitive control interfaces. I believe that foot controlled robotic arms will be commonly used in various surgical as well as industrial applications.

**Keywords-** Supernumerary arm, Robotic assistant, Intuitive control, Limbs coordination, Foot interface, Ownership, Behavioral study.



# Résumé

Beaucoup de tâches industrielles et chirurgicales nécessitent plus que deux mains et une assistance habile. Bien que le travail d'équipe puisse être maîtrisé, il est souvent une source d'erreurs et d'inefficacité, surtout si l'assistant est novice ou peu familier avec l'opérateur principal. De plus, le besoin d'assistance peut devenir problématique lorsque les ressources humaines manquent. Par exemple, un manque de personnel durant la nuit peut être fatal en cas d'appendicite. Notre objectif est donc d'améliorer l'autonomie du chirurgien et peut-être aussi sa dextérité, en lui permettant de contrôler un bras robotique en plus de et avec ses deux mains.

Bien qu'un certain nombre de robots porteurs d'instruments aient été spécialement conçus pour les applications chirurgicales, la meilleure façon de les contrôler reste une question ouverte. Aucune étude comportementale n'a été faite pour déterminer la meilleure stratégie de contrôle et la performance dans des tâches à trois mains. Cette thèse est consacrée à cet objectif. Sur la base d'une revue de la littérature, nous avons sélectionné le pied pour commander le troisième bras de manipulation robotisé. Plusieurs expériences dans des environnements virtuels ont été réalisées pour étudier la faisabilité du control à trois bras résultant.

La première expérience compare les performances obtenues pour attraper des objets qui tombent dans un environnement virtuel en utilisant deux ou trois mains. Les résultats démontrent que la manipulation avec trois mains est préférable à une manipulation à deux mains dans des tâches exigeantes. Moins d'effort est dépensé dans la phase la plus exigeante lorsqu'elle est effectuée avec trois mains qu'avec deux mains. La deuxième expérience, concernant le type de tâches adéquates à la manipulation à trois mains, a permis d'évaluer la courbe d'apprentissage des utilisateurs. Déplacer les mains et un pied simultanément dans des directions opposées a été perçu comme difficile par rapport à une tâche plus dynamique laissant libre la coordination des membres. Les membres sont contrôlés en parallèle plutôt

qu'en série, et avec la même priorité. La performance est améliorée en quelques minutes, avec une meilleure performance dès le deuxième essai. En outre, l'empropiation est constamment augmentée pendant l'expérience.

Deux autres expériences visaient à étudier comment des chirurgiens et étudiants en médecine manipulent l'endoscope en chirurgie laparoscopique dans un environnement virtuel. Les résidents avaient une approche plus positive envers l'utilisation du pied et ont obtenu de meilleurs résultats par rapport aux chirurgiens plus expérimentés. Cela prouve que la meilleure période de formation des chirurgiens pour utiliser un assistant robotisé contrôlé par le pied est lors de leur résidence. Une cavité abdominale virtuelle réaliste a été développée pour la dernière expérience. Cela a eu une influence positive sur la performance des participants et souligne l'importance d'utiliser un contexte familier pour la formation d'une "chirurgie avec trois mains".

Enfin, deux interfaces de pied différentes ont été développées et utilisées pour étudier la stratégie de contrôle la plus intuitive du troisième bras. Un bras robotique avec une caméra est commandé par la translation ou la rotation avec la première interface, ou par la force ou le couple avec la seconde. Une étude comportementale similaire à la chirurgie laparoscopique a été réalisée afin de comparer les deux dispositifs. Le contrôle isométrique de la vitesse a été préféré au contrôle isotonique de position en raison de la charge physique plus faible et une plus grande précision de mouvement du robot. Il a été également montré que le dispositif proposé pour le contrôle des taux isométriques pourrait être utilisé pour une manipulation intuitive des quatre degrés de liberté d'un bras robotique esclave.

Cette thèse est la première étape pour une recherche systématique sur la manipulation avec trois mains avec un assistant robotique contrôlé par le pied. Les résultats démontrent clairement le potentiel du contrôle par le pied pour augmenter l'autonomie de l'opérateur en chirurgie et autres domaines d'applications. Les utilisateurs peuvent apprendre à contrôler le robot avec leur bras en peu de temps et avec peu de charge mentale et peu d'effort physique. Les interfaces de pied développées seront la base de développements futurs d'interfaces de contrôle plus intuitives. Je suis convaincue que l'assistant robotique contrôlé par le pied est une alternative qui sera de plus en plus utilisée dans diverses applications chirurgicales et industrielles.

**Keywords-** Bras supernuméraire, Assistant robotique, Control intuitif, Coordination des membres, Interface de pied, Empropiation, Étude comportementale.

# Contents

<b>Acknowledgements</b> .....	<b>v</b>
<b>Abstract (English/ Français)</b> .....	<b>vii</b>
<b>Contents</b> .....	<b>xi</b>
<b>List of Figures</b> .....	<b>xv</b>
<b>List of Tables</b> .....	<b>xxi</b>
<b>List of Acronyms</b> .....	<b>xxiii</b>
<b>1 Introduction</b> .....	<b>1</b>
1.1 Motivation.....	1
1.1.1 Identification of Collaborative Tasks in Surgery .....	2
1.2 Objectives and Approach.....	5
1.3 Thesis Outline .....	7
<b>2 Review on Supernumerary Manipulation: Robotic Assistants to Neuroplasticity</b> .....	<b>9</b>
2.1 Robotic Assistants for Surgery and Other Applications .....	10
2.2 Plastic Body Perception .....	19
2.3 Surgical Training Simulators .....	24
2.4 Discussion .....	24
<b>3 Performance Comparison between Two-Handed and Three-Handed Manipulation in a Demanding Task</b> .....	<b>27</b>
Summary .....	27
3.1 Introduction.....	28

3.2	Methods.....	28
3.3	Results.....	33
3.4	Discussion.....	42
3.5	Conclusion.....	44
<b>4</b>	<b>Coordination in Three-Handed Manipulation.....</b>	<b>47</b>
	Summary.....	47
4.1	Introduction.....	48
4.2	Methods.....	48
4.3	Results.....	52
4.4	Discussion.....	58
4.5	Conclusion.....	59
<b>5</b>	<b>Camera Manipulation Using the Third Hand.....</b>	<b>61</b>
	Summary.....	61
5.1	Introduction.....	62
5.2	Methods.....	63
5.3	Results.....	66
5.4	Discussion.....	71
5.5	Conclusion.....	73
<b>6</b>	<b>Positioning the Endoscope by Foot: Influential Factors in a Virtual Trainer...75</b>	<b>75</b>
	Summary.....	75
6.1	Introduction.....	76
6.2	Methods.....	77
6.3	Results.....	80
6.4	Discussion.....	83
6.5	Conclusion.....	85
<b>7</b>	<b>Experiments on a Third Robotic Arm Manipulation Using Two Novel Foot Interfaces.....</b>	<b>87</b>
	Summary.....	87
7.1	Introduction.....	88
7.2	Two Foot Interfaces, Two Control Strategies.....	90
	7.2.1 Foot Characteristics.....	90

7.2.2	Elastic–Isometric Foot Interface .....	92
7.2.3	Isotonic Foot Interface .....	93
7.2.4	Thales: The Slave Robot .....	95
7.2.5	Master-Slave Communication.....	96
7.3	Performance of the Two Foot Interfaces.....	97
7.4	Discussion .....	101
7.5	Conclusion .....	102
<b>8</b>	<b>Conclusions.....</b>	<b>105</b>
8.1	Summary .....	105
8.2	Contributions.....	107
8.2.1	Surgical Robotics .....	107
8.2.2	Cognitive Neuroscience .....	108
8.2.3	Other Applications .....	108
8.3	Outlook.....	108
<b>A Laparoscope Manipulation Using the Third Arm with Force Feedback on the Biological Hands .....</b>		<b>111</b>
A.1	Introduction.....	111
A.2	Methods.....	111
A.3	Results.....	113
A.4	Discussion .....	116
A.5	Conclusion .....	117
<b>Bibliography.....</b>		<b>119</b>
<b>Curriculum Vitae .....</b>		<b>131</b>



# List of Figures

Figure 1-1 Observed open surgery: Liver dissection due to metastasis. An assistant holds the tissues away from the point of interest, another assistant holds a tube for sucking the blood from the surgical site.....	3
Figure 1-2 Observed laparoscopic surgery: Partial gastrectomy. Three instruments are involved in suturing the stomach.....	4
Figure 1-3 Observed microsurgery: Reattaching a cut thumb. An instrument is used to hold the tissues in a fixed position.....	5
Figure 2-1 a) EndoAssist: The arrow shows the camera driver [13], b) The robot is controlled by head movements [16]. .....	11
Figure 2-2 a) AESOP robot [28], b) The foot interface can be used as a substitute of voice commands [29]. .....	12
Figure 2-3 LER camera holder and its keypad [20].....	13
Figure 2-4 a) LapMan endoscope holder ( <a href="http://www.medsys.be/surgical-robots">www.medsys.be/surgical-robots</a> ), b) LapStick: A joystick for controlling the robot [34]. .....	13
Figure 2-5 Viky camera holder and its footswitch [37]. .....	14
Figure 2-6 a) RoboLens endoscope holder [38], b) The foot interface can be used as a substitute of voice commands [21]. .....	15
Figure 2-7 The da Vinci surgical system foot interface ( <a href="http://research.intusurg.com">http://research.intusurg.com</a> ). .....	15
Figure 2-8 Experimental setup for the auto-guided system methodology [48].....	17
Figure 2-9 Setup of STAR robot for autonomous suturing [51]. .....	18
Figure 2-10 The design concept of the SRL (Supernumerary Robotic Limb), a) two armed prototype [52], b) single armed prototype [54]. .....	18
Figure 2-11 Illusion of owning a) a rubber hand as a replacement of the real hand [63], b) a second right hand [63], c) an invisible hand [64]. .....	19

Figure 2-12 Illusion of ownership towards a virtual hand [65].	20
Figure 2-13 Illusion of ownership through imagination of a motor act [71].	21
Figure 2-14 Illusion of ownership towards a mechanical hand made of wire [75].	22
Figure 2-15 Rubber foot illusion experiment [78].	23
Figure 2-16 Use of virtual tools modifies the peripersonal space [80].	23
Figure 2-17 Surgical training simulators: a) animal-based trainer [88], b) computer-based trainer [94].	24
Figure 3-1 Experimental design for two vs. three hands experiment: 35 subjects participated in the experiment. 17 of them started with the 2h and then performed the 3h. 18 of them started with the 3h and then performed the 2h.	29
Figure 3-2 Setup to investigate coordinated control of the hands and one foot. One Kinect camera tracks the movements of the hands, another Kinect camera tracks the movements of one foot.	30
Figure 3-3 Catch the three falling objects. a) Three-handed strategy; each hand catches its corresponding object. The yellow virtual hand is controlled by the right foot. b) Two-handed strategy; the middle object can be caught by the left or the right hand.	31
Figure 3-4 The second game round. a) Some subjects moved their limbs within a rectangular workspace. b) Some subjects moved their limbs in a linear manner.	35
Figure 3-5 Limbs' travelled distance in lateral and anterior directions.	35
Figure 3-6 Cumulative travelled distance of left hand, right hand and foot in the three game rounds of the three-handed game.	36
Figure 3-7 Workspaces of left hand, right hand and foot in the three game rounds of the three-handed game.	36
Figure 3-8 Smoothness of movements of each limb using the spectral arc length metric.	37
Figure 3-9 Left hand, right hand and foot velocities for right handed and left handed people in different game rounds.	37
Figure 3-10 Average individual and simultaneous action of the three limbs in three consecutive game rounds.	38
Figure 3-11 Histogram of the instance of action initiation of each limb across the participants.	39
Figure 3-12 Work performed in each game round in the two-handed and three-handed scenarios.	40



Figure 3-13 Average response of all the participants to the questionnaire of Table 3.1. -3: Strong disagreement, +3: Strong agreement. ....	40
Figure 3-14 Ipsatized mean questionnaire ratings for those who started with 2h and those who started with 3h. ....	41
Figure 3-15 Response of participants to the comparative questionnaire of Table 3.2. ....	42
Figure 4-1 First game: Right: Three rectangular targets and three virtual hands, Left: Automatic messages after success or failure. ....	49
Figure 4-2 Second game: Two sets of arrows which indicate the correct direction of movement of the three virtual hands. ....	50
Figure 4-3 Third game: Each of the three falling objects should be caught by the corresponding hand. ....	51
Figure 4-4 Average performance time for each participant for the first game. ....	52
Figure 4-5 Histogram of the time to reach the three targets. (0ms corresponds to the time of reaching the first target.) ....	53
Figure 4-6 Second game: Average allotted time over the subjects in four rounds of two trials. ....	54
Figure 4-7 Average total performance time in the first and the second trials ( $p < 0.003$ ). ....	54
Figure 4-8 Third game: Average allotted time over the subjects in three rounds of two trials. ....	55
Figure 4-9 Third game: Average total performance time in the first and second trials ( $p < 0.014$ ). ....	55
Figure 4-10 Average response of all the participants to the questionnaires for each of the three experiments. Statements are ranked through 1 to 5 (1: Strong disagreement, 5: Strong agreement). *: $p < 0.05$ , **: $p < 0.01$ . ....	56
Figure 4-11 Comparative question: “In which experiment it was easier for you to control the third hand?” ....	57
Figure 4-12 Comparative question: “Which experiment helped you more in mastering the simultaneous control of three hands?” ....	57
Figure 5-1 Biographical information on the surgeons and medical students who carried out the coordinated control of hands and one foot. Five of the 30 students were female, although the gender was found to not affect the results. ....	63
Figure 5-2 Setup with visual feedback to investigate coordinated control of the hands and one foot. ....	64

Figure 5-3 virtual environment with foot displacing the visible area. The largest rectangle represents the whole workspace in the task. The white rectangle is the area visible to the user at the beginning of the game. The view can be shifted to right or left by moving the foot in the corresponding direction. ....	65
Figure 5-4 Average subjects' performance in visual feedback-only setup on the basis of their medical professionalism. ....	67
Figure 5-5 Spectrum of limbs' movements in the first and second trial for a typical subject. ....	68
Figure 5-6 Limbs movements of a sample participant in visual feedback-only setup in (a) the first and (b) the second trials. ....	69
Figure 5-7 Average response of participants in different age categories to the questionnaire. ....	71
Figure 6-1 Statistical information of the subjects' population. ....	77
Figure 6-2 Setup to investigate simultaneous hands and foot movement in a virtual abdominal environment. ....	78
Figure 6-3 Two tasks in virtual abdomen environment: Move a) a ball by a grasper and b) a bar by two graspers, from the initial circle to the target circle. ....	79
Figure 6-4 Hands and foot lateral displacement in a) single handed and b) bimanual tasks. ....	82
Figure 6-5 Subjective assessment of the a) single-handed and b) bimanual experiment. ....	83
Figure 7-1 a) AESOP foot interface [46], b) One DoF foot pedal with force feedback [125]. ....	88
Figure 7-2 Ankle Orthoses with a) three [126] and b) two [127] DoFs. ....	89
Figure 7-3 Four DoFs of a laparoscopic surgical instrument inserted in the abdominal cavity through a trocar. ....	89
Figure 7-4 Rotational DoF of foot ( <a href="http://skimoves.me/tag/ski-boots/">http://skimoves.me/tag/ski-boots/</a> ). ....	91
Figure 7-5 Elastic–isometric FI: Sensor positions and the corresponding manipulated DoFs of a laparoscopic tool. ....	92
Figure 7-6 Sensor block of the elastic–isometric FI. ....	93
Figure 7-7 Isotonic FI: Two translational and two rotational DoFs and the corresponding manipulated DoFs of a laparoscopic tool. ....	94
Figure 7-8 Inclined guidance rail and the foot's rest plate. The plate's angle in the sagittal plane changes by the rail's inclination to follow the user's natural posture. ....	95

Figure 7-9 The modified Thales robot with the added fourth DoF.....	96
Figure 7-10 Master-slave communication platform.....	97
Figure 7-11 The whole area which can be scanned by the camera attached to the Thales robot and the three predefined paths to be followed during the experiment. ....	98
Figure 7-12 Average response of all the participants to the questionnaire of Table 7.2. -3: Strong disagreement, 3: Strong agreement (SEM is represented) .....	100
Figure 7-13 Response of participants to the comparative questionnaire of Table 7.3. ....	101
Figure A-1 Setup with visual and force feedback to investigate coordinated control of the hands and one foot .....	112
Figure A-2 Setup with Average subjects' performance in visual and force feedback setup on the basis of their medical professionalism. ....	114
Figure A-3 Average response of participants in different age categories to the questionnaire of the VFF. ....	115



# List of Tables

Table 2.1 Major laparoscope holders in chronological order and their corresponding control interfaces. ....	16
Table 3.1 Questionnaire statements for the three-handed paradigm. ....	32
Table 3.2 Comparative questions for the two different paradigms. ....	32
Table 3.3 A summary of average objective measures of performance assessment over all the participants in the time spent in each task (2h: two handed experiment, 3h: three handed experiment).....	33
Table 4.1 Common questions for all the three tasks. ....	51
Table 4.2. Comparative questions for the three games.....	51
Table 5.1 Questionnaire statements filled out after the experiment.....	65
Table 6.1 Questionnaire filled after each task.....	80
Table 7.1 Foot characteristics: Average maximum force and torque exerted by three healthy males with a mean age of 24 years old. ....	91
Table 7.2 Questions asked after working with each FI.....	99
Table 7.3 Comparative questionnaire between the two FIs.....	99
Table 7.4 Thales robot vs. isotonic interface ranges of motion for all DoFs and the resulting movement of the robot in response to a given movement of the interface. ....	102
Table A.1 Questionnaire statements filled out after the experiment. ....	112



# List of Acronyms

<b>AESOP</b>	<b>A</b> utomated <b>E</b> ndoscopic <b>S</b> ystem for <b>O</b> ptimal <b>P</b> ositioning
<b>BMI</b>	<b>B</b> rain- <b>M</b> achin <b>I</b> nterface
<b>DoF</b>	<b>D</b> egree of <b>F</b> reedom
<b>EEG</b>	<b>E</b> lectroencephalography
<b>EMG</b>	<b>E</b> lectromyography
<b>EPFL</b>	<b>É</b> cole <b>P</b> olytechnique <b>F</b> édérale de <b>L</b> ausanne
<b>FI</b>	<b>F</b> oot <b>I</b> nterface
<b>fMRI</b>	<b>f</b> unctional <b>M</b> agnetic <b>R</b> esonance <b>I</b> maging
<b>GB</b>	<b>G</b> igabyte
<b>GHz</b>	<b>G</b> igahertz
<b>GUI</b>	<b>G</b> raphical <b>U</b> ser <b>I</b> nterface
<b>HUG</b>	<b>H</b> ospital <b>U</b> niversity of <b>G</b> eneva
<b>KaLAR</b>	<b>K</b> AIST <b>L</b> aparoscopic <b>A</b> ssistant <b>R</b> obot
<b>LapMan</b>	<b>L</b> aparoscope <b>M</b> anipulator
<b>LER</b>	<b>L</b> ight <b>E</b> ndoscope <b>R</b> obot
<b>MANOVA</b>	<b>M</b> ultivariate <b>A</b> nalysis of <b>V</b> ariance

<b>MIS</b>	<b>Minimally Invasive Surgery</b>
<b>RAM</b>	<b>Random-Access Memory</b>
<b>RCM</b>	<b>Remote Center of Motion</b>
<b>SD</b>	<b>Standard Deviation</b>
<b>SDK</b>	<b>Software Development Kit</b>
<b>SEM</b>	<b>Standard Error of the Mean</b>
<b>SRL</b>	<b>Supernumerary Robotic Limb</b>
<b>STAR</b>	<b>Smart Tissue Autonomous Robot</b>
<b>TISKA</b>	<b>Trocar and Instrument Positioning System Karlsruhe</b>
<b>UART</b>	<b>Universal Asynchronous Receiver Transmitter</b>
<b>UDP</b>	<b>User Datagram Protocol</b>
<b>USB</b>	<b>Universal Serial Bus</b>
<b>VR</b>	<b>Virtual Reality</b>
<b>2h</b>	<b>Two-Handed</b>
<b>3h</b>	<b>Three-Handed</b>



# 1

## Introduction

### 1.1 Motivation

Surgeons need assistance for various activities during an operation from holding the endoscope in laparoscopic surgery to suturing and keeping a tissue or an organ out of the way. To become able to provide a constant and effective performance, an assistant requires a learning period [1]. For example, it is reported that the learning procedure of laparoscopic total gastrectomy (stomach removal) is complete after about one hundred cases [2]. In addition, collaboration within the surgical team can be a source of errors and inefficiency especially if the assistant is a novice or unfamiliar with the surgeon [3].

An assistant should pay attention to the surgeon's working manner, as fewer operation errors occur when the surgical team is familiar with the operating surgeon [3]. Each surgeon has his/her unique commanding method; also each assistant may execute the commands with a variable degree of accuracy and precision. Each person has a certain level of proficiency and may be affected by the probable tensions in the surgical room. Previous studies have shown that communication and information flow between the surgeon and the surgical staff has an important role in team performance and a mistake may affect the patient's safety [4]. Communication errors in the operating room can have serious consequences for patients as well as the medical institutions [5].

Nurok et al. reviewed eight papers about the teamwork and communication in the operating room [3]. They found out that teamwork is an important factor for having a safe and efficient surgery. Inadequate teamwork behavior was positively associated with increased odds of death or complications. In addition, there were fewer total errors when the surgical team was familiar with the operating surgeon. In laparoscopic surgery for instance, the assistant responsible for holding the

endoscope should try not to disrupt the operating surgeon. Novice assistants often have difficulty in positioning the camera appropriately in the 3D space, are confused with the fulcrum effect and suffer from fatigue [6]. This also indicates the possibility of complications in more complex tasks during surgery. Apart from the potential complications of collaborative human-human tasks, the presence of many humans in the surgical theater reduces the sterility of the operating room and increases the possibility of infection for the patient.

In the aviation industry, the most common human error preconditions have been identified and introduced by Gordon DuPont in 1993 under the name “The Dirty Dozen” [7]. This was after the most fatal accident in the air traffic in Tenerife in 1977. The number one cause of which was poor communication dynamics in the team. The Dirty Dozen is today the cornerstone of discussion over human factors in aviation industry. The same is still a long way off in surgery, the potential benefit is certainly at least of the same order as with air traffic.

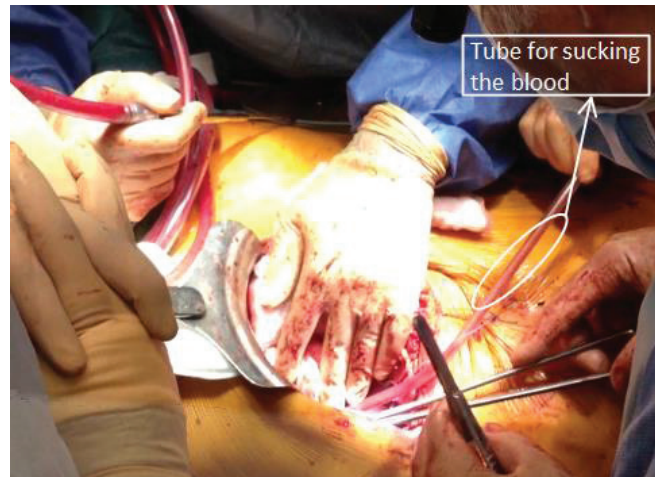
The following subsection provides an overview of our observations of typical surgical situations in which one or more assistant(s) is (are) needed.

### 1.1.1 Identification of Collaborative Tasks in Surgery

Three different types of surgery have been observed and investigated in “Hôpitaux Universitaires de Genève (HUG)”, Switzerland and SickKids Hospital in Toronto, Canada: open surgery, laparoscopic surgery and microsurgery. Each of these three types of surgery are discussed in this subsection.

#### **Open Surgery**

In open abdominal surgery, the patient’s abdomen is cut for 8 to 12cm so that the surgeon can operate by holding and touching the organs directly by their hands. In the observed open surgery, a tumor on the patient’s liver was removed due to metastasis. After opening the abdomen, a cylindrical part of the liver was extracted. The open arteries were clamped and the muscles, fat and skin layers were sutured separately. An assistant helped the surgeon performing these tasks by holding the target tissue using a grasper. Another assistant held a tube for sucking the blood from the surgical site (Figure 1-1). The surgeon had to direct her to point the tube to a specific direction.



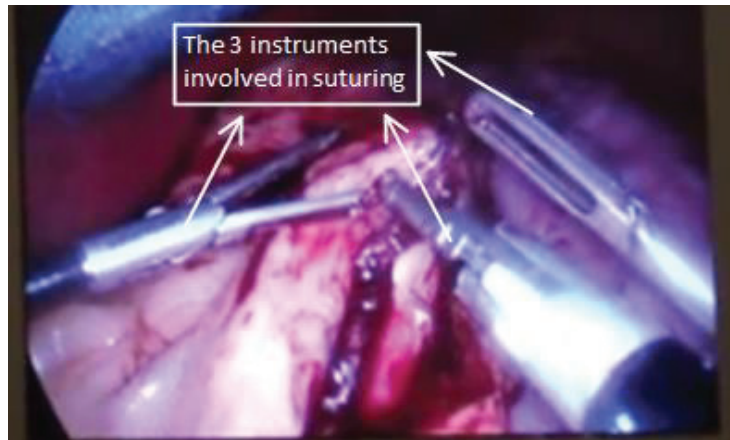
**Figure 1-1 Observed open surgery: Liver dissection due to metastasis. An assistant holds the tissues away from the point of interest, another assistant holds a tube for sucking the blood from the surgical site.**

## Laparoscopic Surgery

In laparoscopic surgery, also called minimally invasive surgery (MIS), a minimum of three small incisions sized between 0.5 and 1.5cm are made on the abdomen. Surgical instruments are then inserted in the abdominal cavity through the incisions. The camera (endoscope) is the omnipresent instrument in laparoscopic surgery. It provides a view of the abdominal cavity on screen. The first observed laparoscopic surgery was removal of half of the stomach (partial gastrectomy) of an obese patient. In this surgery, 6 holes were pierced in the patient's abdomen through which the endoscope and other surgical devices were inserted. A large variety of tasks were carried out during the operation such as cutting the stomach by a catheter, pulling out the separated part, suturing the rest of the stomach inside the abdomen and suturing the holes made for inserting the instruments. Apart from suturing, in most of the tasks (even for cutting) the required movements were basically positioning of the surgical instruments in the appropriate location, grasping the tissue and pressing a button to start burning the tissue if applicable (for the catheter). For the suturing, three instruments were needed, two of which were actively involved in the process and the third, held by an assistant, was for supporting the thread and making the stitch more stable (Figure 1-2). The third instrument had to be placed in the right position with no movement of its jaws. The endoscope was constantly handled by an assistant and pointed at the desired location instructed by the surgeon.

The second observed laparoscopic surgery was appendectomy. It is one of the simplest laparoscopic surgeries. However, in spite of its simplicity, it is essential to perform this operation in time to prevent the fatal consequences of late dissection of

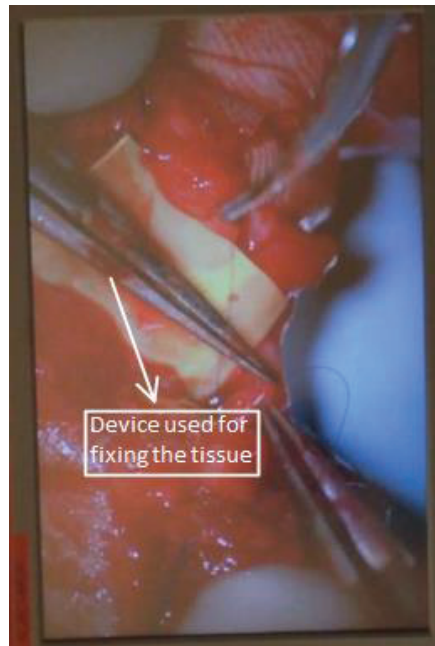
an affected appendix. In the observed surgery, only one assistant is needed for holding the endoscope during the operation.



**Figure 1-2 Observed laparoscopic surgery: Partial gastrectomy. Three instruments are involved in suturing the stomach.**

### Microsurgery

Microsurgery refers to delicate operations performed by small instruments and under microscope. In the observed microsurgery the thumb of the patient is cut from the distal joint. Microsurgery is needed for the delicate nerves and vessels to be sutured so that the finger will regain the blood circulation and sensation. During the surgery a wire is first drilled into the thumb to fix the thumb in its place. Next the tendon is sutured and the nerves, arteries and veins are prepared for microsurgery. Due to the small dimensions of the nerves and vessels it is important for them to be kept fixed during the suturing under the microscope (Figure 1-3). This task is done by an assistant. Holding of a part may last for a long time as the suturing task in this kind of surgery is very delicate and needs high precision. Also, the surgeon needs to change the instrument for suturing the artery through the process. An instrument with blunt tip is for going into the vessel and another instrument is for holding the thread during suturing. Microsurgery usually takes hours and although the surgeon sits during the surgery, the long periods of concentration and repeated task of suturing and holding the tissues are quite exhausting.



**Figure 1-3 Observed microsurgery: Reattaching a cut thumb. An instrument is used to hold the tissues in a fixed position.**

### **Similarities among Observed Surgeries**

Consequently, many tasks in open, laparoscopic and micro- surgery need one or several assistants. These tasks need coordination with the main surgeon for long lasting and/or repetitive actions. In open and laparoscopic surgery some examples are holding a suction tube to clear blood, pushing organs aside and directing the endoscope. In microsurgery, delicate tissues should be held in a fixed position for suturing during long intervals. It requires high concentration to continuously adjust the position of the tool tip.

The need of collaborative assistance to the main operator on one hand and the potential problems of human-human teamwork on the other hand define the motivation of this dissertation. Our objective is to provide the operator with an easy to use control strategy to command a robotic assistant which can deliver the necessary help and omit the unnecessary human-human collaboration. The questions that readily arise are on the best control strategy, the human capacities and the most appropriate applications. Section 1.2 describes our approach to tackle these points.

## **1.2 Objectives and Approach**

This thesis is thus motivated by the problems of collaborative tasks between the main surgeon and the assistants. During an operation, there are many tasks for

which the surgeon needs assistance as his/her two hands are already occupied in handling surgical tools. The assistant works in collaboration with and under the commands of the main operator. We envision that a robotic arm under the surgeon's control could enable him/her to carry out many tasks alone. This could for example facilitate the suturing process as all the three instruments will be controlled by the surgeon, which may ensure more coherent movements than by collaborating with an assistant. In addition, demanding tasks requiring high precision, high force and/or minimum possible tremor may be performed by the robotic arm rather than a human assistant. Finally, fewer team members result in less costly operations [8].

Surgical team has to maintain sterile hands and gloves. Apart from direct operational assistance, an unsterile arm may be handy to touch and manipulate unsterile objects in the operational room without infecting the user's hands e.g. adjusting the parameters of a device through pushing its buttons. Also in emergency situations, with reduced availability of surgical staff, a surgeon with a robotic arm under their control may be capable of performing a surgery with fewer human assistants.

Collaboration among the team members for manual work is common in other fields such as industrial applications as well. This is mainly due to the limited dexterity and power of humans with "only" two hands. Industrial workers require assistants for tasks that need more than two hands e.g. holding a piece while they perform an action on it, coordination of more than two instruments and tasks which need high power. Although this thesis is focused on surgical applications, the results are applicable in other collaborative tasks too.

Ideally, the main operator should have direct control on all the "hands" that are involved in performing a task. This will assure a procedure with less need of communication among the team members. As a first step towards this ultimate goal, this thesis is a behavioral investigation on control of a supernumerary robotic arm for three-handed manipulation in surgery.

While the technology of developing a robotic arm is essentially available, the best control strategy for three handed collaboration in surgical applications is still an open question. As the first step in this thesis, the control strategy for the third arm is chosen after investigation of the possible options currently used for controlling robotic arms. Our selection is on the basis of intuitiveness and ease of use of the control interface.

The selected strategy is then tested via a series of behavioral studies in virtual reality (VR). Various VRs and user interfaces are tested in different experiments. Engineers, medical students and surgeons participated in our studies. This is the first study on the possibility of controlling three hands simultaneously, the type of tasks that can be done with this strategy and the learning curve of users. The



presence of the end users i.e. surgeons, in the early stages of our research is an added value. It provides the necessary insight to their needs and capabilities to which the final control strategy should be adapted.

Finally, two master interfaces are developed to control an instrument holder slave robot. Commands are delivered differently in the two interfaces. The performances of the two devices are compared through experimental studies.

In conclusion, the need of greater autonomy and increased safety (or reduced risk) in industrial and surgical applications encourage the use of robotic arms to make the operator more autonomous and dexterous. This thesis is a step towards providing the operator with an intuitive control strategy adapted to human capabilities and limitations. The problem is addressed by behavioral studies in virtual as well as real environments by means of various user interfaces.

### 1.3 Thesis Outline

The thesis dissertation is structured as follows. Chapter 2 reviews the existing robotic surgical assistants and their control strategies, the plasticity of the brain and its ability of incorporating artificial limbs as biological limbs, and finally the surgical training systems. In Chapter 3 the investigation of the possibility of three-handed interventions is started by comparison of two-handed vs. three-handed manipulation in a demanding task in virtual reality. Chapter 4 examines the learning curve of subjects and the feasible level of complexity of the tasks for a three-handed manipulation through subjective and objective measures. In Chapter 5 a manipulation task is performed by the two biological hands and the camera (the endoscope) is positioned by the foot controlled third (robotic) arm. This application is elaborated in a more realistic virtual environment in Chapter 6. This developed environment can serve as a virtual trainer for three-handed applications. A further step is taken in Chapter 7 by developing two different foot-operated control interfaces. An experimental study to discuss the performances of the associated control strategies is conducted. The dissertation is concluded by a summary of its contributions and future directions for further investigations.





# 2

## Review on Supernumerary Manipulation: Robotic Assistants to Neuroplasticity

### Summary

This chapter presents the existing literature for supernumerary manipulation in three main subsections. Each subsection covers the studies related to a certain aspect of the present research.

First, the existing robotic arms used to assist surgeons and their corresponding control strategies are presented. This provides the necessary background for understanding the motivation behind choosing the control strategy proposed in this thesis. Also it justifies the design of the foot interfaces presented in Chapter 7.

Then, cognitive neuroscientific studies on supernumerary limbs, ownership, embodiment and the necessary conditions for such perceptions are explained. The knowledge presented in this subsection serves as a starting point for the behavioral studies conducted during this research and presented in Chapters 3 to 5.

Finally, surgical trainers are introduced to provide an insight of their role in improving surgeons' performance. Chapter 6 is developed on the basis of the information presented in this subsection.

### 2.1 Robotic Assistants for Surgery and Other Applications

In surgery, an operating team usually consists of a surgeon, an anesthetist, and one or more assistant(s). Surgeons need assistance for various tasks such as holding the endoscope, suturing, retracting an organ, etc. Many of these tasks require the assistant to hold the instrument accurately in a fixed position with minimum tremor, for long periods of time. A novice, nervous or tired assistant may find it too difficult to meet these physically and mentally demanding requirements. An assistant should also be familiar with the way a specific surgeon is working, as fewer operation errors occur when the surgical team is familiar with the operating surgeon [3], and communication errors on the operational room can have serious consequences for patients as well as institutions [5].

In addition, many hospitals currently lack personnel in the operating room, due to several factors including the reverse age pyramid, tightening of social healthcare budgets, lack of interest for the operating room and political decisions limiting the number of surgical assistants [9]. Studies such as [9] suggest that most surgeries could be completed by a sterile nurse and a single surgeon working with an automated assistant. An automated assistant is a robotic instrument holder actuated by humans. Laparoscopic solo surgery can be considered a safe procedure although further technological developments should offer the surgeon better control on the surgical tools during the operation [10, 11].

#### Robotic Assistants for Holding the Endoscope in Laparoscopic Surgery

In an ideal operation, the surgeon should have direct control on all the devices that are involved in the surgery. During the last twenty years some efforts have focused on replacing human assistants by robotic arms. In the surgical field the potential advantages of robots include precision, steady positioning of tools, cost effectiveness in long term and fatigue reduction for assistants [12]. Camera holders are the most common robotic assistants in operating rooms. These devices are either motion controlled (e.g. EndoAssist by head motion tracking [13-16]), voice activated (e.g. AESOP [17] and Image Tracking System[18]), or commanded by a joystick (e.g. LapMan [19]), a keypad [20] or a multidirectional footswitch (e.g. RoboLens [21]). AESOP has been used as the camera holder of the Zeus Robotic Surgical System [22].

The first robotic assistant, called EndoAssist (Armstrong Healthcare Ltd, High Wycombe, Bucks, UK), was first introduced in a paper in 1982 [23]. The robot has three degrees of freedom (DoFs). The movements of the camera are commanded by the surgeon's head movements (Figure 2-1a). This is done using a head mounted infrared emitter and a sensor which detects the motion of the emitter (Figure 2-1b). A foot clutch is used to avoid any unnecessary movement of the camera. A study was performed to compare the EndoAssist with a human camera holder. The results

showed no significant difference in complication rates or total operative times between the two methods.

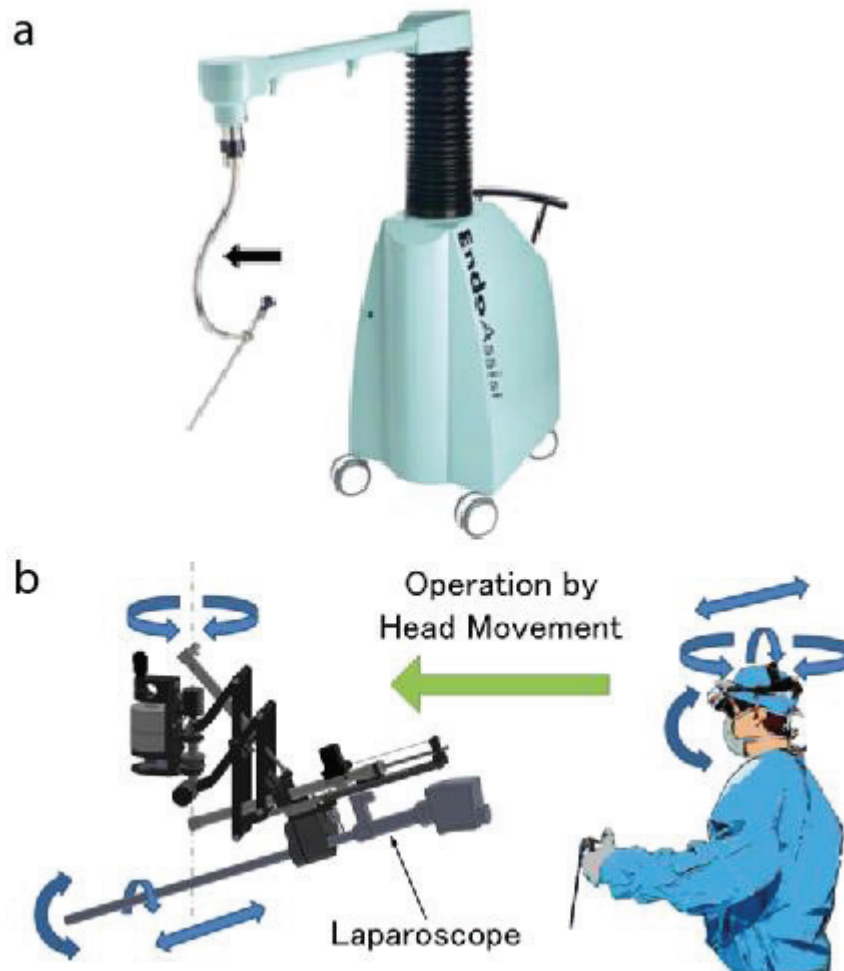
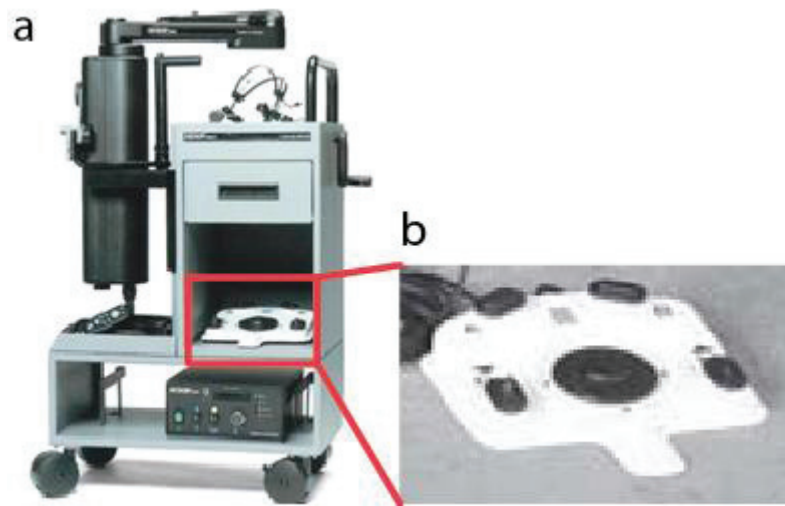


Figure 2-1 a) EndoAssist: The arrow shows the camera driver [13], b) The robot is controlled by head movements [16].

Another example is the three-armed Zeus Robotic Surgical System for laparoscopic surgery commercialized in 2001. The system consists of a master and a slave side [24]. The surgeon performs the operation at the master console. His/her hands' movements are then mimicked by two arms of the slave robot inside the patient's abdomen. The third arm which holds the endoscope, called AESOP (Automated Endoscopic System for Optimal Positioning), is actuated by voice commands or a footswitch. AESOP was first released in 1994 in USA (Figure 2-2a). The control commands with the voice of the operating surgeon are stored in a card and can be used during the surgery [25] (Figure 2-2b). A set of six voice commands determines the robot's direction of movement. "Move" command initiates constant velocity motion which can be stopped by "Stop" command. "Step" command displaces the robot for a predefined distance in the given direction.

A study has shown that it is possible for the surgeons to perform a laparoscopic surgery with the help of a Zeus system without any human assistant [26]. Kavoussi et al. compared the accuracy of AESOP with human assistant in holding the endoscope during urological laparoscopic surgery [27]. They assessed the operation time, erroneous camera motions, complications and outcome. The robotic arm holds the camera in a steadier manner with less inadvertent movements. They concluded that a robotic camera holder is more effective and accurate compared to a human assistant.



**Figure 2-2 a) AESOP robot [28], b) The foot interface can be used as a substitute of voice commands [29].**

According to Wagner et al. AESOP and EndoAssist have the same surgical performance [30]. EndoAssist responds accurately and enables the surgeon to have the exact desired view. However, it is bulky, cannot be mounted on the table and its activation and inactivation is dependent on a pedal. The surgeon has to push a pedal to start or stop the tracking of his own head movements; otherwise the camera will respond to every single movement of the surgeon's head which is not desirable.

The LER (Light Endoscope Robot) is a three DoFs camera holder developed in 2003 by Berkelman et al. [20, 31]. The system provides the surgeon with a compact and lightweight endoscope holder which can be directly placed on the patient's abdomen. The robot can be controlled either by voice commands or a six-buttons keypad (Figure 2-3). The voice commands are the same as AESOP [32, 33].

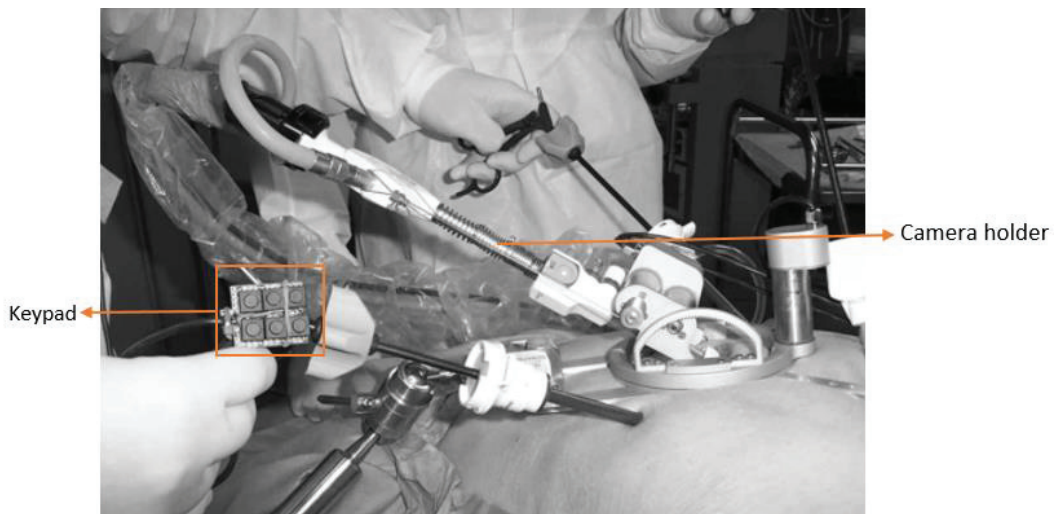


Figure 2-3 LER camera holder and its keypad [20].

The commercialized three DoFs LapMan (Laparoscope Manipulator, Medsys, Belgium) endoscope holder robot developed in 2004 is controlled by a joystick (LapStick) clipped onto a laparoscopic surgical instrument under the surgeon's index finger (Figure 2-4) [34]. The robot moves with a constant speed as long as a switch is pressed on LapStick and it stops when the switch is released. It allows the surgeon to operate in conditions of restricted surgical assistance. This device is not as popular as the other two devices explained previously.

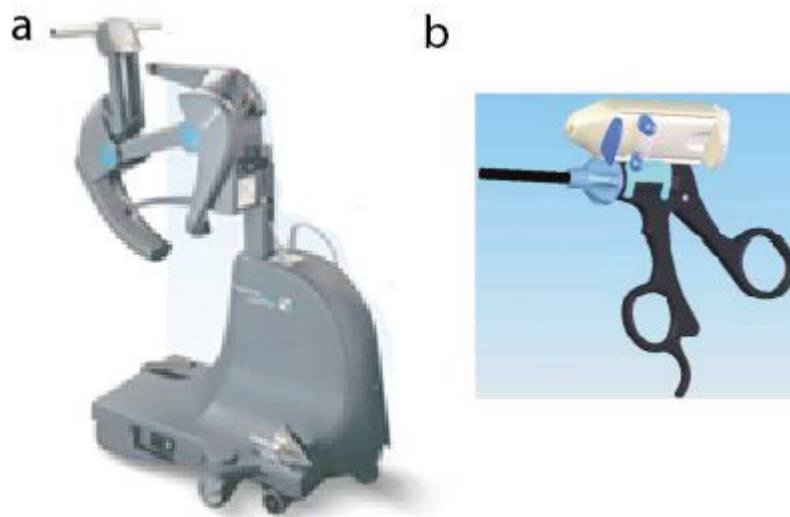


Figure 2-4 a) LapMan endoscope holder ([www.medsys.be/surgical-robots](http://www.medsys.be/surgical-robots)), b) LapStick: A joystick for controlling the robot [34].

Also in 2004, Kwon et al. proposed a combination of the two main control methods used for the camera holding robots [6, 35]. Their three DoFs robot named KaLAR (KAIST Laparoscopic Assistant Robot), may be controlled either by voice commands

or by tracking the surgical instrument which has already been marked. By each voice command the robot moves in the corresponding direction for a predetermined amount. According to their research, in order to reduce the required voice commands for controlling the robot, more information about the surgical operation should be available. For example, change of surgical instruments and insertion and extraction of the instruments may be used as indicators of transition phases.

Finally, there is the commercialized ViKY [36] released in 2007, originated from the TIMC-IMAG laboratory [32] and manufactured by Endocontrol company (Figure 2-5). It can be entirely sterilized and may be directly attached to the operating table. The robot has three DoFs and can be controlled either by voice commands or a multidirectional footswitch. The commands result in displacements with two different amplitudes. The user may choose between these two amplitudes. In the next version, they are trying to improve the control paradigm based on visual servoing and instrument tracking [36]. They hope to have a relatively independent camera holder so that the surgeon can focus more on the operation.



**Figure 2-5 ViKY camera holder and its footswitch [37].**

RoboLens is among the latest endoscope holders developed for laparoscopic surgery (Figure 2-6a) [38]. It has three active and one passive DoFs. The robot can be controlled either by voice commands or a six-buttons footswitch (Figure 2-6b). Voice commands can be used while pressing a pedal. The robot continues moving in the indicated direction until releasing of the pedal.



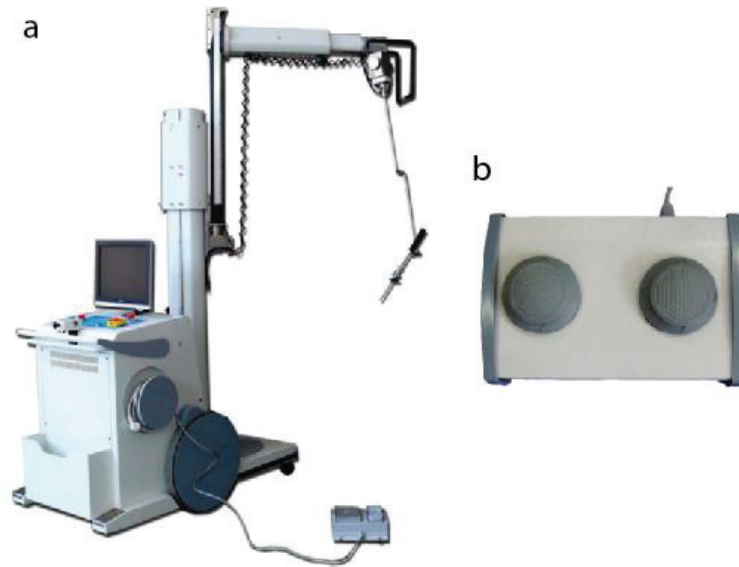


Figure 2-6 a) RoboLens endoscope holder [38], b) The foot interface can be used as a substitute of voice commands [21].

Apart from the single-arm endoscope holders, the most well-known surgical robotic system, da Vinci™ (Intuitive Surgical Inc.), with multiple tele-manipulated robotic arms, incorporates an endoscope holder. A foot interface with five pedals provides the surgeon with some control over the robotic arms. The first pedal disengages instruments from the controllers, the second one disengages the camera from the master for proper positioning and the third one is used for adjusting the focus of the camera. The two last pedals are for bipolar coagulation and monopolar cautery respectively [39]. All the pedals are placed close to each other on a planar surface (Figure 2-7).



Figure 2-7 The da Vinci surgical system foot interface (<http://research.intusurg.com>).

Table 2.1 summarizes the major laparoscope holders and their corresponding control interface. Voice commands are used in seven out of nine systems and footswitch has been more frequently used in recent developments. It has been shown that robotic

camera holders can replace the human camera holder and may be more convenient to the surgeon [18]. They provide accurate and fast camera movements with the same quality as the human assistants [40]. In fact, even a semi-active tissue retractor is more stable than a human assistant [41].

Passive camera holders, such as TISKA (Trocar and Instrument Positioning System Karlsruhe) in 1999 [42], and a system from the University Medical Center Utrecht [43] have been also developed. Their positioning by one hand has been reported as more time consuming but more comfortable compared to human assistants [44]. Providing the surgeon with direct control on the endoscope positioning in laparoscopic surgery improves the surgeon's ability to perform explorative and manipulative tasks [45].

In AESOP, the foot control is faster with less operator-interface failure, but the voice control is more accurate [46]. However, subjects learned to work with the foot control faster than with voice control. Foot pedal is preferred to voice command interface by surgeons in the general evaluation of the RoboLens as well [38]. Although the first laparoscope holder was developed more than thirty years ago, the diversity in the proposed control strategies represents the existing debate in the domain.

**Table 2.1 Major laparoscope holders in chronological order and their corresponding control interfaces.**

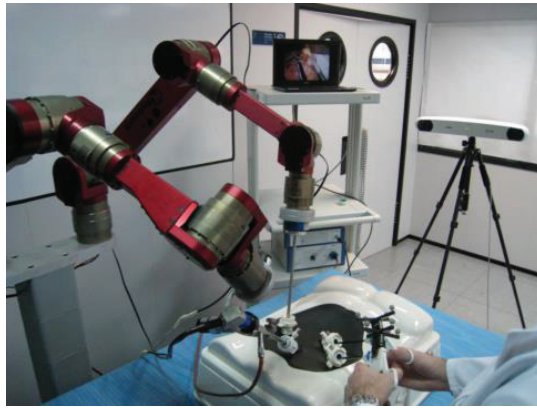
Camera holder	Year	Control strategy
EndoAssist	1982	Tracking head motions - Foot clutch to (un)lock the arm
AESOP	1994	Voice commands - Footswitch
Image tracking system	2000	Voice commands
LER	2003	Voice commands - Keypad
LapMan	2004	Joystick
KaLAR	2004	Voice commands - Tracking surgical instruments
ViKY	2007	Voice commands - Footswitch-Tracking surgical instruments
RoboLens	2011	Voice commands - Footswitch

### Robotic Assistants for Other Applications

Besides the camera holders, in 2012, Knoll et al. used a novel learning method to automate the knot tying and suturing procedures [47]. The idea is for the robot to perform the suturing autonomously. In 2010, Bauzano et al. released a paper and introduced a novel motion control system for a two armed robot (CISOBOT) in



minimally invasive surgery (Figure 2-8) [48]. They reported their most recent advances in 2013 [49]. The robot has a camera on one arm and a surgical instrument on the other. Force sensors are used for minimizing the exerted force on abdominal wall. The instrument can automatically move to a desired position provided that it is marked and the target destination is shown to the robot. Their ultimate goal is to replace the human assistant in laparoscopic surgery by an automatic robot which is aware of its responsibility at each stage of the surgery. Also, in 2016, Khadem et al. designed a robotic grasper for minimally invasive surgery to be used in autonomous grasping against a variable pull force [50].



**Figure 2-8 Experimental setup for the auto-guided system methodology [48].**

One of the most recent developments in this field is the STAR (Smart Tissue Autonomous Robot) developed for autonomous suturing (Figure 2-9). The robot outperforms expert surgeons in the in vivo experiments [51].

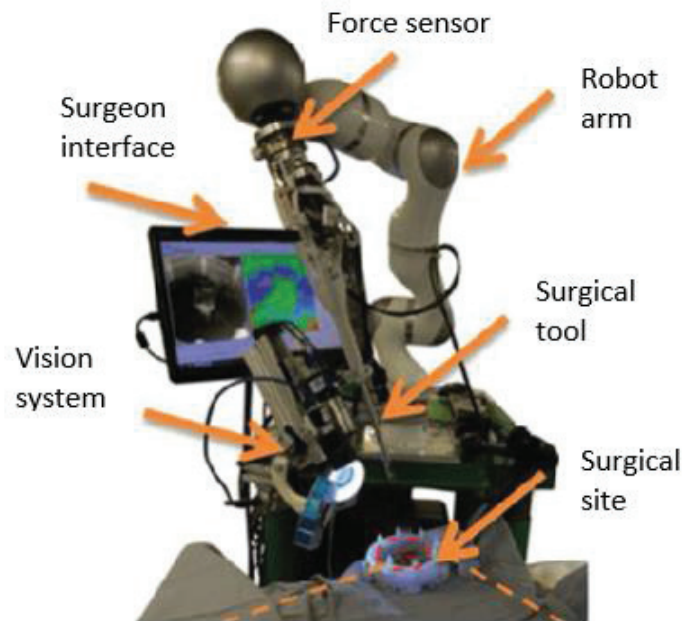


Figure 2-9 Setup of STAR robot for autonomous suturing [51].

Since 2012, Prof. Asada's group at MIT is working on a supernumerary robotic limb (SRL) for the industrial use [52-56]. The arm assists the user like a human assistant in some simple tasks such as holding a workpiece with its end effectors while the user performs the drilling operation (Figure 2-10). It is going to observe the users actions and act accordingly. The SRL uses sensors and vision to gather data from the environment.

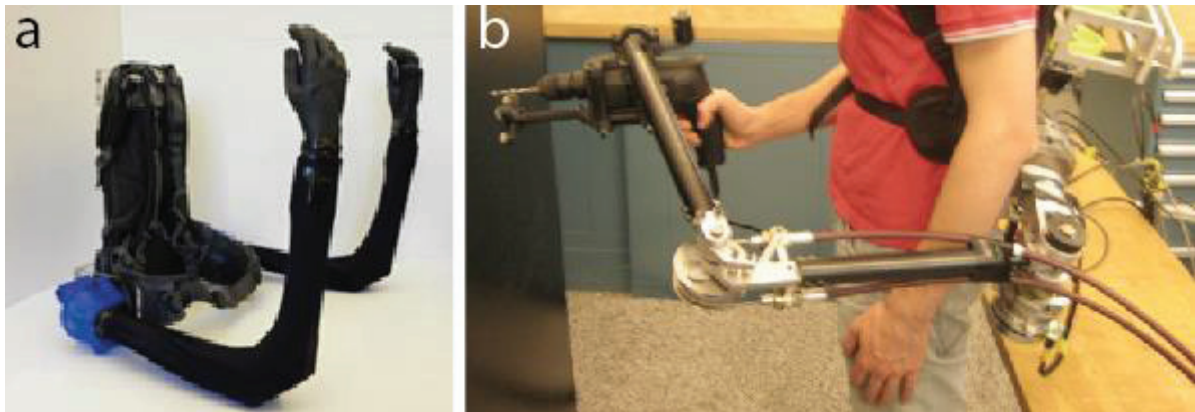


Figure 2-10 The design concept of the SRL (Supernumerary Robotic Limb), a) two armed prototype [52], b) single armed prototype [54].

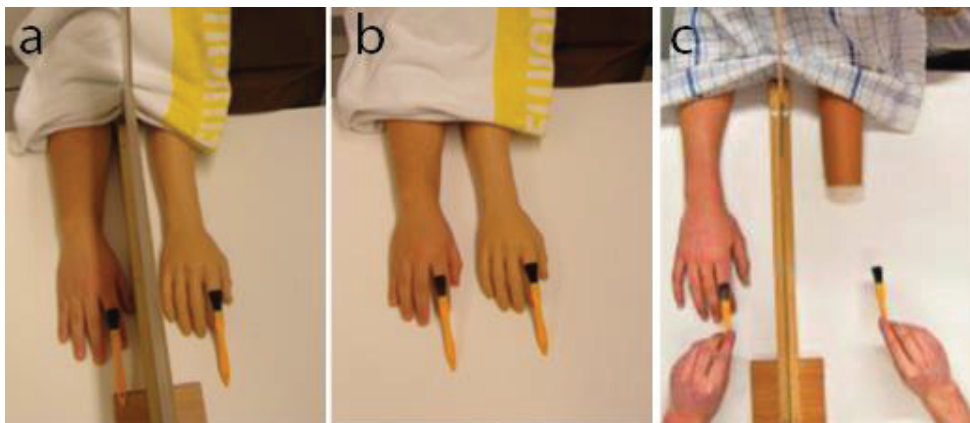
Other alternatives for controlling a robotic arm in surgical or industrial applications are based on the measure of muscle activity using electromyography (EMG) or brain activity through electroencephalography (EEG). EMG from upper limbs has been used for controlling anthropomorphic robotic arms in real time [57, 58]. Although the method is reported to be successful, it requires the placement of the electrodes in the

right positions. It is not convenient for surgeons to go through the placement procedure before each surgery. In addition, the user's arm is completely engaged in controlling the robotic arm. This is not acceptable for surgical applications in which the surgeon's arms should be free to perform complex interventions. Also, EEG can be used for initiating a predefined procedure, the robot may then perform a programmed task automatically [59, 60]. EEG can interpret the brain signals only as 0 and 1 limiting the application of this control interface to pre-programmable tasks which is not the case in surgical applications.

## 2.2 Plastic Body Perception

The control strategy for an assistive robotic arm should allow the operator to stay focused on the task with minimum distraction. Ideally, the robotic arm should be perceived by the operator as a supernumerary limb that can be commanded as intuitively as the biological limbs. This relates to research on embodiment reviewed e.g. in [61].

The first evidence on the possibility of inducing the perceptual illusion of owning an artificial hand was provided by the famous rubber hand illusion experiment in 1998 [62]. As presented in Figure 2-11a, in this experiment one hand of the subject is placed on a table and behind a barrier in a manner that the subject cannot see it. An artificial rubber hand is placed at the other side of the barrier in the view of the participant and in the same spatial direction as their biological hand. Both hands are struck simultaneously with two brushes. It is reported that after ten minutes participants felt the touch of the viewed brush, as if the rubber hand has felt the touch.



**Figure 2-11** Illusion of owning a) a rubber hand as a replacement of the real hand [63], b) a second right hand [63], c) an invisible hand [64].

Also, it has been shown that with appropriate multisensory correlations a virtual limb can be integrated into body perception [65]. The proof study was designed as

the original rubber hand illusion experiment with the rubber hand replaced by a virtual hand viewed from a first person perspective (Figure 2-12). Tactile stimulation of the participant's real hand with synchronous visual stimulation of the virtual hand results in a drift of ownership towards the virtual hand. This is proven both by subjective measures as well as proprioceptive drift. This finding is consistent with the results of functional magnetic resonance imaging (fMRI) studies [66] showing that embodying a virtual limb through congruent visuo-tactile-proprioceptive stimulation engages the same multisensory areas that are activated when participants view their real hand being touched [67], or experience the classical rubber hand illusion [68].

In case of a large overlap between the real and virtual bodies, visuo-proprioceptive cues are sufficient to create the illusion. However in case of minimal overlap between the virtual body and the real one, the visuo-tactile cues become important [69]. In addition, a realistic skin tone and body shape are important factors in the embodiment [69], [70]. In this sense, attaching the third arm to the body will facilitate the illusion of ownership over the supernumerary limb.



**Figure 2-12 Illusion of ownership towards a virtual hand [65].**

Subjective aspects of the illusion of the virtual limb ownership may also be evoked through imagination of a motor act accompanied by movements of a virtual hand [71]. For example, if the participant imagines a hand movement to right, the virtual hand moves to right synchronously (Figure 2-13). Also, spontaneous movement of the virtual hand produces measureable muscle activity in the real arm. However, the proprioceptive drift does not happen.



**Figure 2-13 Illusion of ownership through imagination of a motor act [71].**

In 2011, Guterstam et al. demonstrated the possibility of inducing the perceptual illusion of having a supernumerary right hand, such that the subject actually felt that he has a second right hand [63]. Their experiment is like the rubber hand illusion experiment with both real and rubber hands in the view of the participant. Both hands are struck simultaneously with two brushes (Figure 2-11b). After two minutes the rubber hand is felt like a second right hand. This is proven through subjective evaluation as well as measurement of skin conductance. Their findings suggest that the embodiment of a supernumerary limb is possible if it is aligned with the body in an anatomically similar fashion as the real limbs. Bashford et al. have proven that the sense of ownership towards a supernumerary hand may be induced using a virtual limb [72]. In their experiment, participants had the illusion of controlling the virtual hand's movements by their brain signals and developed a strong sense of ownership towards the supernumerary virtual hand.

Guterstam et al. have also demonstrated the possibility of developing a sense of ownership towards an invisible hand [64]. In this study, the real hand is hidden behind a barrier, then the real hand is struck synchronously with the movements of a brush which moves in the view of the participant in the air (Figure 2-11c). There is no rubber hand present in this experiment.

New studies about the rubber hand illusion show that congruent mapping between the real and artificial hands is necessary for developing sense of ownership towards the rubber hand [73]. Also the morphological similarities between the tool and the body part favors the induced embodiment [74], however it is not essential as shown in the mentioned invisible hand illusion experiment. Even a mechanical hand made of wires can result in a sense of embodiment, although the effect is not as strong as that of a realistic rubber hand [75]. The experimental study is once more similar to the rubber hand illusion experiment with the real hand out of the participant's sight and the hand made of wire in sight (Figure 2-14). Both hands are brushed

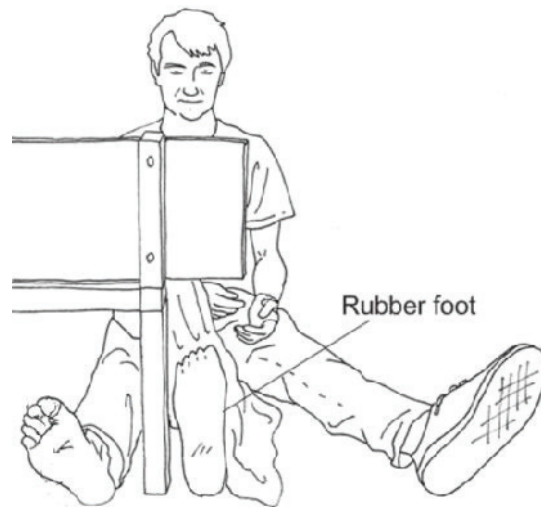


simultaneously for two minutes. Subjective and objective measures prove the development of sense of ownership towards the mechanical hand.



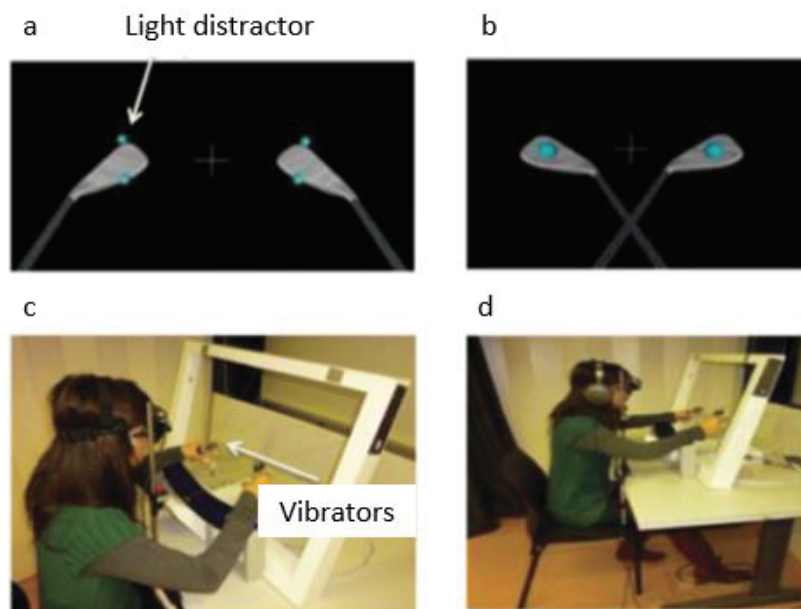
**Figure 2-14 Illusion of ownership towards a mechanical hand made of wire [75].**

Other studies have shown that while multiple supernumerary limbs can be incorporated into *bodily image* (i.e., the sense of ownership towards the supernumerary limb), only one can be included in the *body schema* (the ability to control the supernumerary limb) [76]. To induce simultaneous sense of ownership towards two supernumerary rubber hands, these should be at the same distance from the subject's hand [77]. It has also been proven that the rubber hand illusion can be reproduced for the foot, either by matching or mismatching vibrotactile stimulations on the real and rubber feet [78]. In the proposed experiment, participants sit on a bed with legs stretched out. One leg is hidden behind a screen and a rubber foot is in the sight of the participant with the same appearance and direction as the hidden foot (Figure 2-15). Both real and rubber feet are brushed synchronously.



**Figure 2-15 Rubber foot illusion experiment [78].**

In addition, it has been demonstrated that the size of the incorporated body part is not important and ownership illusion can be induced towards very small or large bodies [79]. In 2012, Sengul et al. proved that even using virtual-robotic tools will modify the peripersonal space of the user in a way that the tool seems to be a part of his body [80]. They used crossmodal congruency task to provide evidence. In this task subjects respond to tactile stimulation applied to their finger ignoring the visual distractors superimposed on the tip of the virtual-robotic tool (Figure 2-16).



**Figure 2-16 Use of virtual tools modifies the peripersonal space [80].**

Bodily perception can be experimentally modified through visual cues, functional adaptation and embodiment of tools and prostheses [81, 82]. Research proves the

plasticity of the human brain not only to master the use of external tools but also to reshape the body representation [83]. As a conclusion, accumulating evidence from literature suggests that body-ownership is very flexible and the brain can incorporate a non-corporal object into one's bodily image [84].

### 2.3 Surgical Training Simulators

Surgeons need training to acquire the necessary surgical skills before performing their first operation on patients. Training simulators are available for different interventions from dental procedures to orthopedics and laparoscopy [85, 86]. All types of endoscopy simulators including mechanical trainers [87] as well as animal [88] and computer-based [89] trainers improve trainee's endoscopic skills [90] (Figure 2-17). Among the various available training simulators, VR trainers have the potential to become an essential piece of surgical education curriculum [91].

A virtual laparoscopic training program with progressive complexity provides the possibility of transferring the acquired skills to an actual scenario while maintaining patient safety [92, 93]. Compared with the traditional surgical training method, besides providing repetitive tasks and variable complexity for trainees, VR based laparoscopic surgery simulators can also record the training progress, assess trainees' surgical skill objectively and offer informative feedback [94]. For example, performance metrics within endovascular simulations improve with simulation training [95]. It has been proven that six hours of training in virtual environment results in an improvement equivalent to fifteen to thirty colonoscopies [96]. Besides surgical expertise, introducing new technologies in the operational room demands new competences for the surgeons [97].

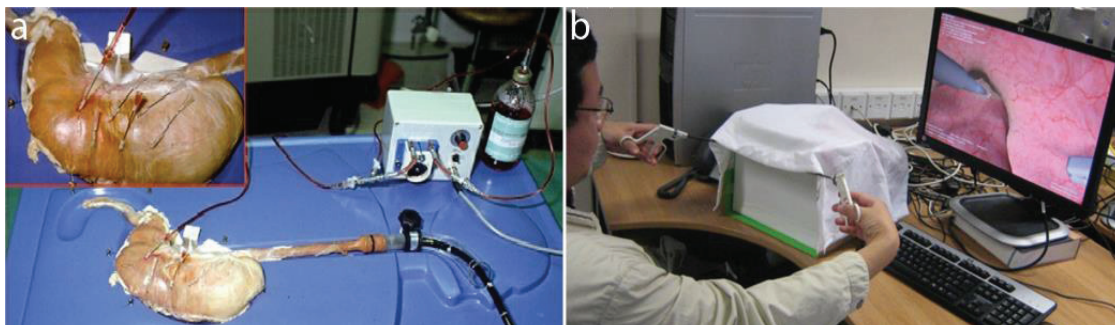


Figure 2-17 Surgical training simulators: a) animal-based trainer [88], b) computer-based trainer [94].

### 2.4 Discussion

A dozen of robotic assistants for holding the endoscope in laparoscopic surgery as well as other applications have been developed so far. However the best control



strategy for such a device is still an open debate. Although the previously developed control strategies are found to be useful, they require the operators to divide their attention between the task and the control of the robot. The commands are not intuitive and giving a command is at the cost of interruption (e.g. for using the joystick or turning the head in a direction away from the area of interest), or distraction (e.g. selection of the correct switch or pedal). Each of these strategies has the capacity of controlling from two to four DoFs. Increasing the number of DoFs results in a complex control interface which may put the accuracy and safety of the platform at stake.

On the basis of findings about the brain's capacity to integrate additional limbs into the bodily schema, we envision that through an intuitive control strategy the robotic arm can ideally be perceived as one's own arm. Although the foot has been previously used for simple actions, its capacity for a more complex manipulation has not been studied. The established ability of the foot for fine manipulations of the pedals of an automobile as well as a musical instrument, e.g. the piano, encourages us to conduct an investigation on its capabilities as a robotic arm commander for surgical and industrial applications. As the foot is idle during many surgical and industrial procedures, its usage won't interrupt an ongoing task performed by hands. In the following chapters, our step by step investigation of the foot's capacity, the most suitable tasks for a foot controlled arm and the best control strategy is presented.



# 3

## Performance Comparison between Two-Handed and Three-Handed Manipulation in a Demanding Task

### Summary

Surgeons equipped with a third arm under their direct control may be able to perform certain surgical interventions alone; this would reduce the need for a human assistant and related coordination difficulties. However, does human performance improve with three hands compared to two hands? To evaluate this possibility, we carried out a behavioral study on the performance of naive adults catching objects with three virtual hands controlled by their two hands and right foot. The subjects could successfully control the virtual hands in a few trials. With this control strategy, the workspace of the hands was inversely correlated with the task velocity. The comparison of performance between the three and two hands control revealed no significant difference of success in catching falling objects and in average effort of the subjects during the tasks. Subjects preferred the three-handed control strategy, found it easier, with less physical and mental burden. Although the coordination of the foot with the natural hands increased trial after trial, about two minutes of practice was not enough to develop a sense of ownership towards the third arm.

The findings of this chapter were published in the Nature's Scientific Reports journal with the following authors list: Elahe Abdi, Etienne Burdet, Mohamed Bouri, Sharifa Himidan and Hannes Bleuler. Elahe Abdi designed and performed the experiments, analyzed the results and wrote the manuscript under the supervision of Etienne Burdet, Mohamed Bouri, Sharifa Himidan and Hannes Bleuler: E. Abdi, E. Burdet, M. Bouri, S. Himidan, and H. Bleuler, "In a demanding task, three-handed manipulation is preferred to two-handed manipulation," *Scientific Reports*, vol. 6, p. 21758, 02/25/online 2016.

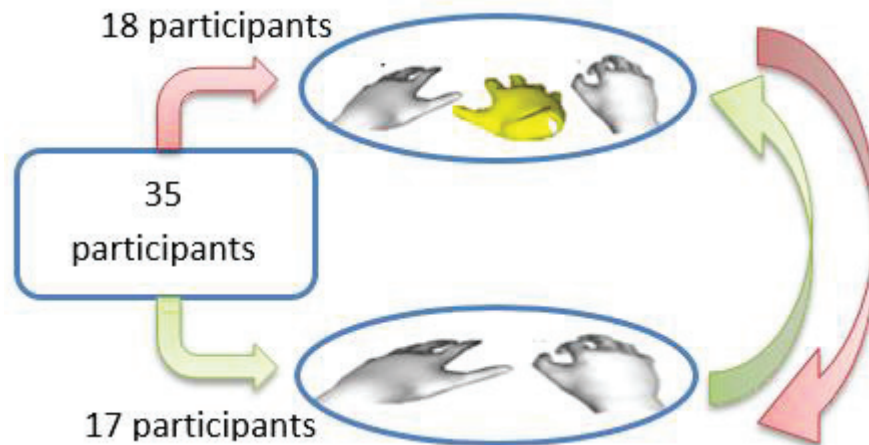
### 3.1 Introduction

The state of the art in cognitive neuroscience research suggests that it is possible to develop a sense of ownership towards a supernumerary limb. However, it is not at all clear whether using three hands (two biological hands plus a robotic arm) improves the performance compared to using two hands in a demanding task, and whether and how the three hands would work together. It is also important to assess the users' preference for different possible control strategies with two or three hands. The present chapter aims at investigating such questions. An experiment is designed in virtual reality in which the same task is performed with two virtual hands vs. with three virtual hands. The third hand is controlled by tracking foot movements. The functional differences in limb usage in two-handed (2h) and three-handed (3h) scenarios are investigated. The performance of the subjects and the physical and mental burden of the tasks are compared. The learning curves of the participants, their sense of ownership towards the third hand and the ease of control of the third hand are analyzed.

### 3.2 Methods

#### Experiment

Thirty-five subjects with mean age of  $23 \pm 5$  years participated in the experiment. Thirteen were female and ten left-handed. The experiment was approved by the Brain Machine Interface (BMI) Ethics Committee for Human Behavioral Research at EPFL (Reference: BLEULER 2014 04 24), and the methods were carried out in accordance with the approved guidelines. Informed consent was obtained from all subjects. The experiment was developed to investigate and compare the performance of participants in carrying out a demanding object grasping task using two distinct strategies: with two virtual hands (2h) or with three virtual hands (3h). All the subjects participated in both scenarios. 17 subjects started the grasping game with the 2h strategy and then proceeded to the 3h, while 18 other participants started with 3h and then proceeded to the 2h, so that the influence of practice with one strategy or the other could be investigated (Figure 3-1).

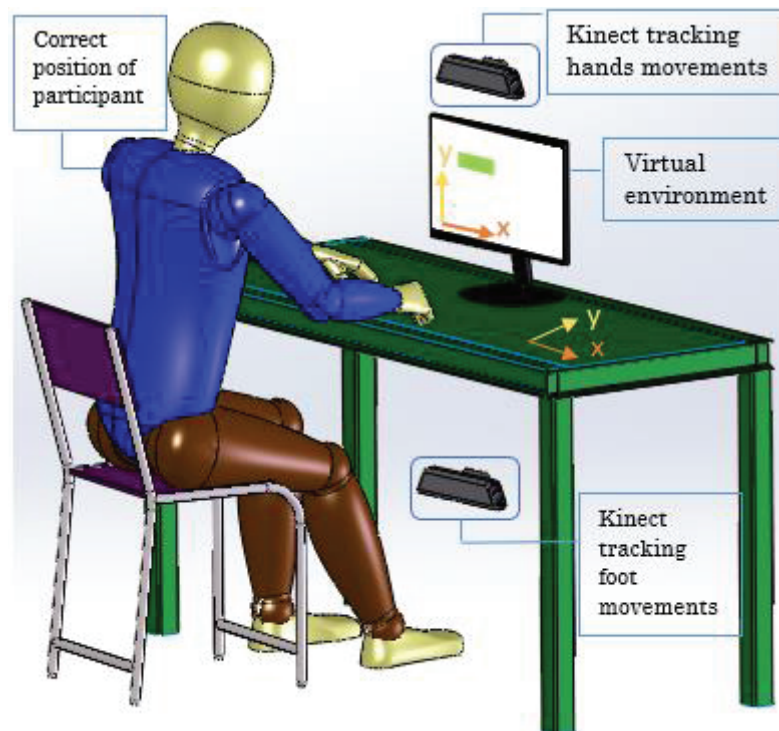


**Figure 3-1 Experimental design for two vs. three hands experiment: 35 subjects participated in the experiment. 17 of them started with the 2h and then performed the 3h. 18 of them started with the 3h and then performed the 2h.**

### Setup

As mentioned in Chapter 2, a first sight of the fake or virtual body is essential in the illusion of ownership [69], and that the body shape is an important factor of the embodiment [69], [70], such that for example the ownership illusion cannot be induced for noncorporeal objects like a piece of wood [64], [98]. These findings motivated us to use for the three hands a realistic view of a hand in virtual reality. Also we decided to reproduce the finger movements of the two real hands in the corresponding virtual hands.

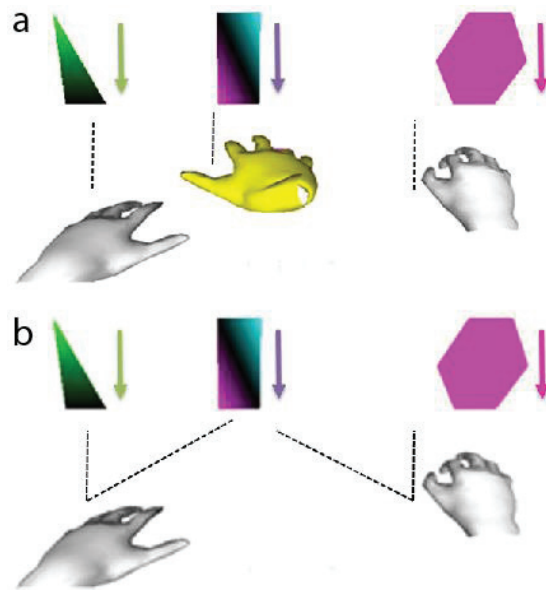
The experiment is designed as a virtual game played with two or three virtual hands. Two virtual hands move on a computer monitor according to the movements of the two real hands of the player, while the third virtual hand is controlled by the player's right foot, i.e. the third hand trajectory on the monitor corresponds to the foot's planar movement on the floor. Two Microsoft XBOX 360 Kinect© depth cameras are used to track the movements of the limbs: one for the two real hands and the other for the feet (Figure 3-2). As each software development kit (SDK) can support only one camera, a network of two computers is used to provide appropriate feedback of the three virtual hands in real-time. To detect the finger motions, we use the 3Gear Systems Company SDK that has a library of most popular hand gestures. The 3Gear can recognize a limited number of hand gestures, using a computer with the following minimum specifications: Intel Core i7 2.3GHz, 8 GB of RAM and Windows 7 64-bit. In all of the games, the two gray hands move with the two real hands of the player while the yellow hand is controlled by the foot.



**Figure 3-2 Setup to investigate coordinated control of the hands and one foot. One Kinect camera tracks the movements of the hands, another Kinect camera tracks the movements of one foot.**

### Paradigm

A game has been implemented for the 2h and 3h-scenarios in which three polygons with different shapes falling from top to the bottom have to be caught before they reach the ground (Figure 3-3). The left and right objects can be caught by pinching with the corresponding (grey) hands while the middle object has to be touched with the foot controlled (yellow) virtual hand. An object is “touched” when the centre of gravity of the (yellow) virtual hand gets within a circular target zone of the centre of the falling rectangle, where the diameter of the target zone corresponds approximately to the width of the rectangle.



**Figure 3-3** Catch the three falling objects. a) Three-handed strategy; each hand catches its corresponding object. The yellow virtual hand is controlled by the right foot. b) Two-handed strategy; the middle object can be caught by the left or the right hand.

When an object is caught, it disappears and a new object starts falling from top. The screen is divided into three columns of equal width. Each object stays in its allocated column but it doesn't always fall from the same spot within its zone. This change in horizontal location forces the player to stay concentrated and active during the game. Each game has three rounds. In the first two rounds, if three samples of each object are caught, the next round starts with double falling speed compared to the previous round. In the last (fastest) round, if three samples of each object are caught, a win message will appear on the screen. In each round, if more than three samples from the same object are lost, the game will be over and a failure message appears on the screen.

In the 2h paradigm, the left and right objects can be caught only with the respective hand while the middle object can be caught with either hand. The 3h paradigm uses the translational movement of the right foot to control the third virtual hand. Three virtual hands appear on the screen that can catch three falling objects. The left and right objects are caught as in the 2h experiment while the middle object can now only be caught by the third – foot controlled – virtual hand. In both scenarios, the user should pinch to catch the triangle and the hexagon. The rectangle object placed in the middle is “caught” when the virtual hand's palm comes over it (with no need of any special gesture).

### Assessment

In each game, the planar position of the virtual hands are recorded at a frequency of 5Hz and the hands' movement velocity is then calculated. In addition, the time of

pinches with the left and right hands are recorded. This is completed by a subjective assessment at the end of the three-handed experiment through a questionnaire about different aspects of the control strategy, the sense of ownership towards the third hand, the perceived level of complexity of the task and the physical and mental burden of the game as described in Table 3.1. Each statement should be ranked in an ordered response Likert scale, from -3 (for “strong disagreement”) to +3 (for “strong agreement”). Question 8 is a control question.

**Table 3.1 Questionnaire statements for the three-handed paradigm.**

<b>Questionnaire statements</b>	
<b>Q1</b>	It felt natural for me to control three hands simultaneously.
<b>Q2</b>	It was easy for me to control the third hand by foot.
<b>Q3</b>	I got confused with the number of tasks that I had to perform simultaneously.
<b>Q4</b>	It was physically tiring for me.
<b>Q5</b>	It was mentally tiring for me.
<b>Q6</b>	I felt as if the virtual third hand was my own.
<b>Q7</b>	I felt as if my foot was turning into the third hand.
<b>Q8</b>	I felt as if my real hands were turning into the ‘virtual’ hands.

At the end of the whole experiment, subjects answer four questions on the two different games (Table 3.2). These questions compare the two games with respect to the ease of the games, the control strategies as well as their mental and physical burden.

**Table 3.2 Comparative questions for the two different paradigms.**

<b>Questionnaire statements</b>	<b>The one with TWO hands</b>	<b>The one with THREE hands</b>	<b>NONE</b>
<b>Q1</b>	In which experiment was it easier to catch the objects?		
<b>Q2</b>	Which strategy did you prefer for this game?		
<b>Q3</b>	Which experiment was mentally more tiring for you?		
<b>Q4</b>	Which experiment was physically more tiring for you?		



### Statistical Analysis

The data sets are tested for normality using the Jarque-Bera test. The normally distributed data sets are compared using the t-test whereas the Wilcoxon rank sum test is used for comparison of non-normal independent sets with a significance level  $p < 5\%$ . The significant differences are reported wherever applicable. The applied method is presented in the text wherever applicable. The standard error of the mean (SEM) values are reported through the text and in the diagrams.

### 3.3 Results

The results are presented for the average performance of all the participants as well as left- and right-handed subjects. No significant difference between females' and males' performance was detected in any of the measures analyzed below, thus we do not differentiate the subjects according to their sex in the following. Subjects' performance is assessed through objective measures of efficiency, workspace, smoothness, velocity, limb's simultaneous action, number of pinches by each hand and effort. Table 3.3 presents a summary of average objective performance measures over all the participants in the total time spent in each of the 2h and 3h scenarios. Each measure will be presented in detail in this section.

**Table 3.3** A summary of average objective measures of performance assessment over all the participants in the time spent in each task (2h: two handed experiment, 3h: three handed experiment).

	Total time for successful completion of the game (s)		Number of objects lost during the game
	<b>Efficiency</b>	<i>2h</i> 127±7	
	<i>3h</i> 126±9		3.5±0.8
	Left hand	Right hand	Foot
<b>Workspace (cm<sup>2</sup>)</b>	<i>2h</i> Depends on the hand choice for caching the middle object.		
	<i>3h</i> 205±25	179±24	231±26
<b>Travelled distance (cm)</b>	<i>2h</i> Depends on the hand choice for caching the middle object.		
	<i>3h</i> 442±30	466±25	555±32
<b>Smoothness (<math>\eta_{\text{sal}}</math>)</b>	<i>2h</i> -22±2	-20±1	—
	<i>3h</i> -21±2	-22±2	-29±4
<b>Velocity (cm/s)</b>	<i>2h</i> 4.8±0.3	5.5±0.5	—
	<i>3h</i> 3±0.9	2.9±0.7	4.2±0.9

### 3.3 Results

		<b>Left &amp; Right hands</b>	<b>Left hand &amp; Foot</b>	<b>Right hand &amp; Foot</b>	<b>Left hand &amp; Right hand &amp; Foot</b>
<b>Limbs' simultaneous action time</b>	<i>2h</i>	33±3%	—	—	—
	<i>3h</i>	13±2%	6±1%	4±1%	5±1%
<b>percentage</b>					
		<b>Left hand</b>		<b>Right hand</b>	
<b>Number of pinches</b>	<i>2h</i>	62±10		61±11	
	<i>3h</i>	39±6		42±5	
<b>Effort (J/kg)</b>	<i>2h</i>	3.7±0.6			
	<i>3h</i>	3.6±0.7			

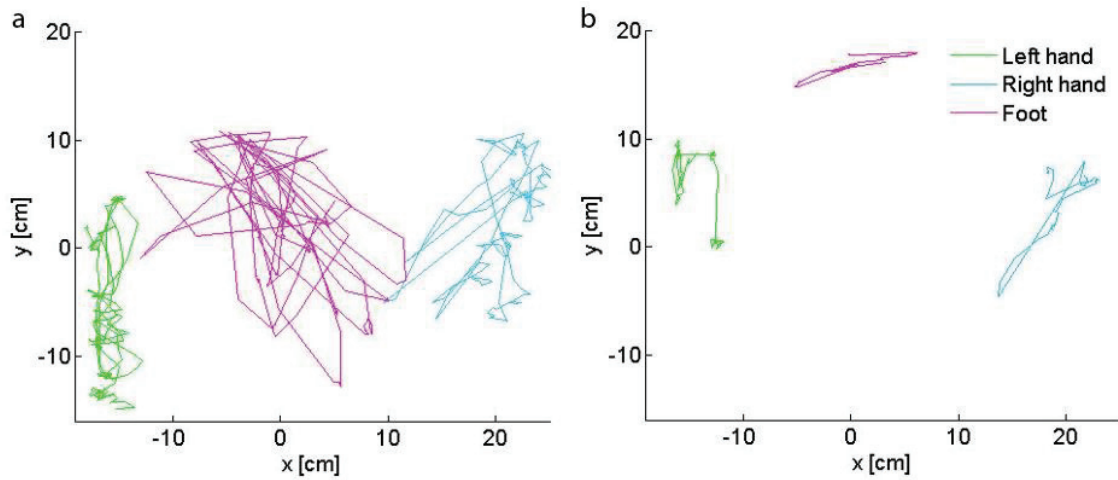
#### Efficiency

26 of the 35 subjects managed to finish the game with two hands and 25 subjects managed to finish the three hands game 3h. The 2h game was finished in  $127\pm 7s$  and the three-handed one in  $126\pm 9s$ . Slightly fewer objects were lost in the 3h scenario ( $3.8\pm 0.8$  for the 2h game vs.  $3.5\pm 0.8$  for 3h). There are large individual performance differences among the subjects. In 2h there was a direct relation between the increase in game's speed and the number of lost objects i.e. as the speed increased more objects were lost. However, there was no such relation in 3h. In this paradigm, the performance got worse in the second game round compared to the first one but then improved in the third round. In the maximum speed condition, 46% less objects were lost in 3h compared to 2h.

#### Workspace

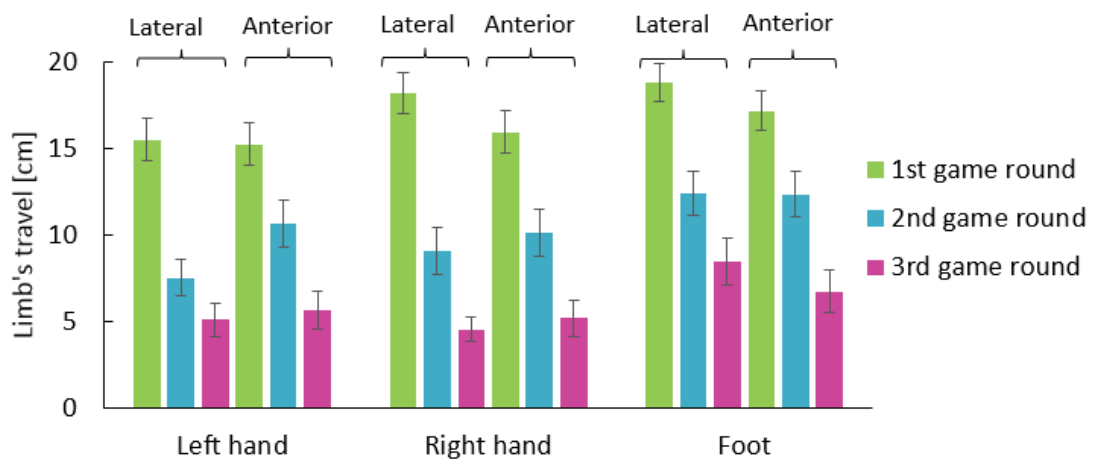
It is useful, in the design of control interfaces, to know the comfortable workspace of the limbs with respect to each other and as a function of movement velocity. Right-handed participants used the right hand for catching the middle object in  $63\pm 6\%$  of the cases and left-handed participants used the left hand in  $69\pm 11\%$  of the cases. In the three-handed game, different subjects had quite different strategies in moving their limbs. Some moved their limbs in a rectangular space, whereas others performed actions with minimal movements resulting in nearly linear workspaces (Figure 3-4).

### 3 Performance Comparison between Two-Handed and Three-Handed Manipulation in a Demanding Task



**Figure 3-4** The second game round. a) Some subjects moved their limbs within a rectangular workspace. b) Some subjects moved their limbs in a linear manner.

The distance travelled decreased as game speed increased, both in the lateral and anterior directions for every limb (Figure 3-5).



**Figure 3-5** Limbs' travelled distance in lateral and anterior directions.

Figure 3-6 shows the average cumulative distance travelled over subjects for each limb and each game round. The distance the hands travelled decreases linearly through the game rounds. The workspace of each limb is defined as the smallest rectangle containing all the paths of that limb. The size of the workspace was negatively correlated with the falling speed of the objects such that the workspace decreased of half when the velocity was doubled in each game round (Figure 3-7).

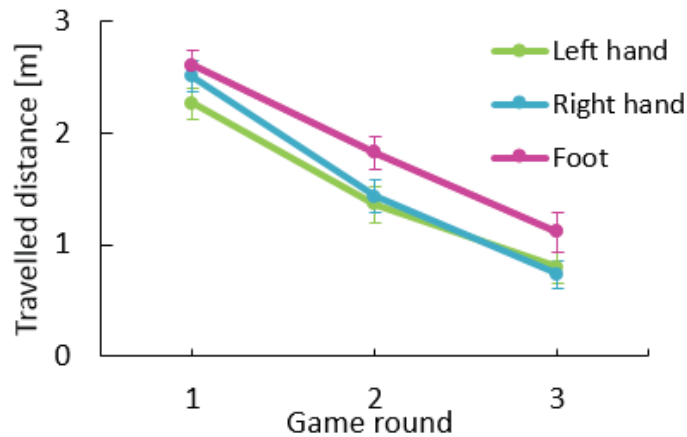


Figure 3-6 Cumulative travelled distance of left hand, right hand and foot in the three game rounds of the three-handed game.

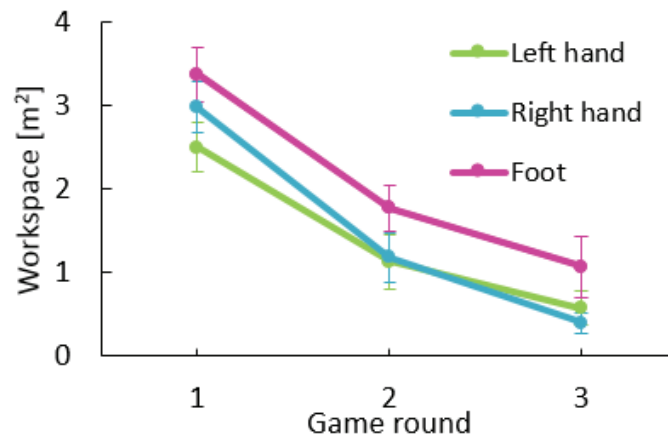


Figure 3-7 Workspaces of left hand, right hand and foot in the three game rounds of the three-handed game.

### Smoothness

The smoothness of the movements of each limb was quantified using the spectral arc length metric ( $\eta_{sal}$ ) [99]. It was found to be independent of the sex and dominant hand of the subjects. Figure 3-8 presents the average smoothness of the limbs' movements over the subjects in the three game rounds. On average over all subjects, the smoothness improved 45% in the second and third game rounds with respect to the previous round. In the first round, the foot was more jerky, however it improved in subsequent rounds with a value similar to the hand in only three rounds (left hand:  $-10.25$ , right hand:  $-11.40$ , foot:  $-12.49$ ).

### 3 Performance Comparison between Two-Handed and Three-Handed Manipulation in a Demanding Task

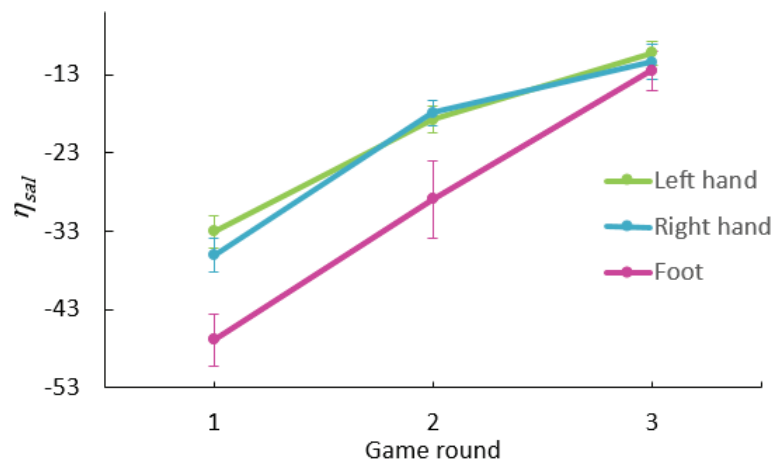


Figure 3-8 Smoothness of movements of each limb using the spectral arc length metric.

#### Velocity

Subjects were free to use each of their hands to catch the middle object in 2h, consequently the hands' speed depends on the hand's choice. However, in 3h subjects are constrained to use each of their three limbs (two hands and one foot) for catching a specific object. The results of Figure 3-9 show that the difference between limbs' velocities became larger as the game speed increased in consecutive game rounds for both left and right-handed subjects. Over all subjects, the average velocities of two hands were not noticeably different (right hand:  $2.9 \pm 0.7$  cm/s, left hand:  $3 \pm 0.9$  cm/s). The foot was faster ( $4.2 \pm 0.9$  cm/s) but the velocity difference among the limbs was not significant.

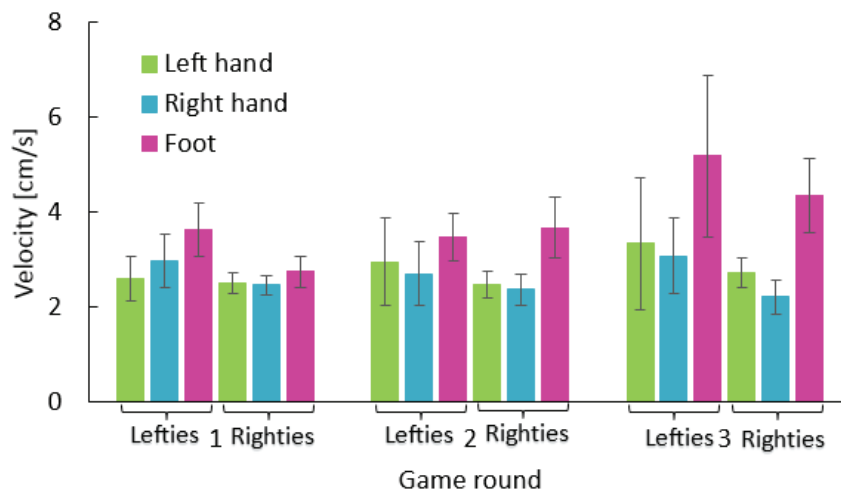


Figure 3-9 Left hand, right hand and foot velocities for right handed and left handed people in different game rounds.

### Limbs' Action

In the two-handed game, the simultaneous action (defined as the time during which both hands are moving simultaneously) increased constantly through game rounds from 23% to 44% of the total time of the game. In the three-handed experiment there was less simultaneous movement between one of the hands and the leg than between the two hands (Figure 3-10). Also, on average for all subjects, in 34% of the total time none of the limbs were moving.

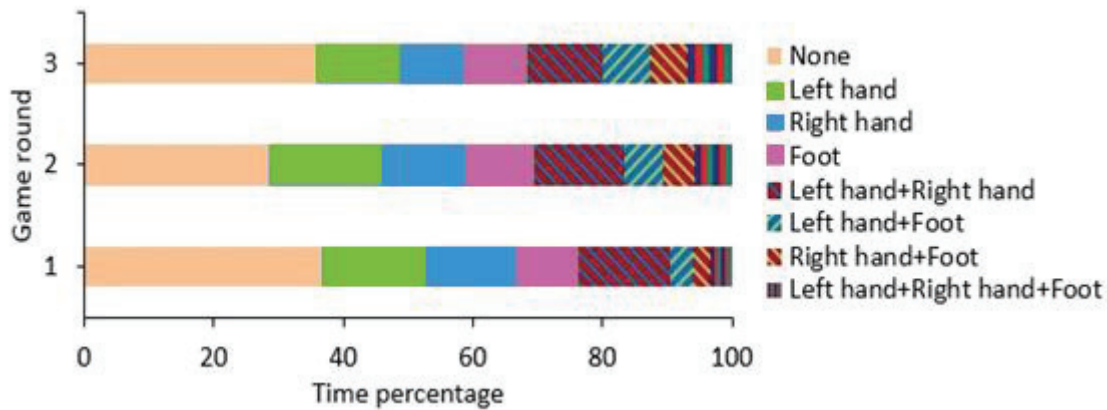


Figure 3-10 Average individual and simultaneous action of the three limbs in three consecutive game rounds.

The mean time percentage of periods of simultaneous movements during the whole game and over the participants for each combination of two limbs was: right hand-left hand: 18.5%, left hand-foot: 11%, right hand-foot: 9.7%, both hands and the foot: 5.3%. Males and females had almost the same rate of simultaneous movement between the limbs with a maximum difference of 2.8% in any combination. A remarkable characteristic is that over the game rounds the proportion of simultaneous movements for foot and either hand or with the two hands increased monotonically. On average over all the subjects, this increase was 74% from the first to the second round, which is a significant difference ( $p < 0.02$ ,  $z = -2.4197$ , rank sum test) and 19% from the second to the third round, which is not significant.

The number of pinches for catching objects decreased with increasing speed. Left-handed subjects pinched significantly more with their left hand ( $p < 0.03$ ,  $z = 2.25$ , rank sum test) compared to right-handed subjects. Both groups pinched more with their dominant hand compared to the non-dominant hand.  $52 \pm 5\%$  of pinches in the two-handed scenario and  $58 \pm 6\%$  of them in the three-handed one are done in the target area i.e. over the object. The histogram of the instance of action initiation of each limb shows that all the limbs moved within 10 seconds from the start of the game (Figure 3-11). In most cases the foot was the last limb that moved. However, there is no systematic order in the limbs' movements, i.e., the different limbs move in parallel rather than serially.

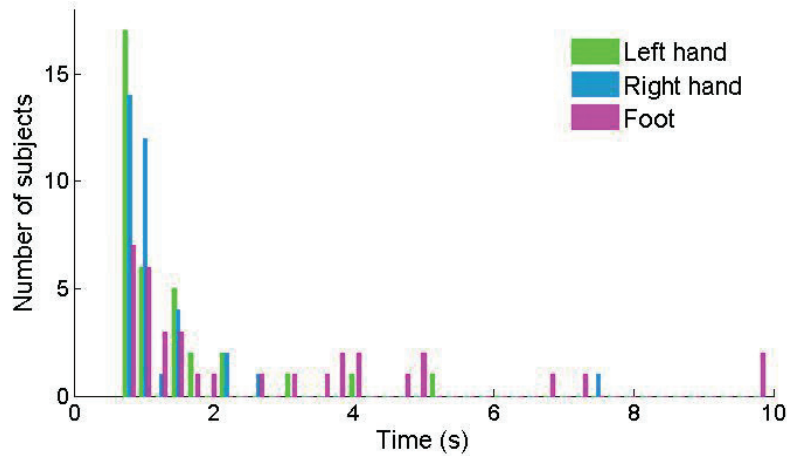


Figure 3-11 Histogram of the instance of action initiation of each limb across the participants.

### Effort

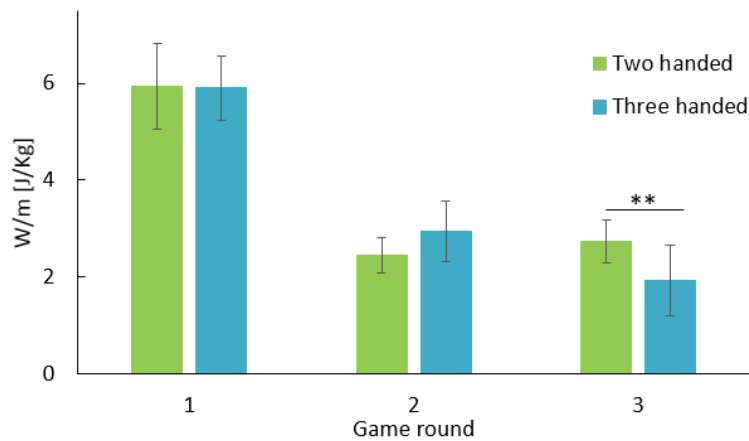
We define effort as the work per mass. This measure gives insight into the amount of consumed energy in each of the two-handed and three-handed experimental strategies and it can be used as a metric of performance efficiency. Work is defined in equation (3.1). In this equation, the parameters are defined as follows:  $W$ : work,  $F$ : force,  $m$ : mass,  $s$ : displacement,  $\dot{s}$ : acceleration,  $t_0$ : the time at which the game starts,  $t_e$ : the time at which the game ends.

$$W = \int_{t_0}^{t_e} F ds = \int_{t_0}^{t_e} m \dot{s} ds \quad (3.1)$$

By discretizing equation (3.1), work per mass (effort) can be derived as a function of displacement ( $\Delta s_i$ ) in each time step ( $\Delta t=0.2s$ ) as presented in equation (3.2). The summation is over the sampling period starting at  $t_0$  ( $i=1$ ) and ending at  $t_e$  ( $i=n$ ).

$$\frac{W}{m} = \sum_{i=1}^n \left( \frac{\Delta s_i}{\Delta t^2} \times \Delta s_i \right) = \sum_{i=1}^n \frac{\Delta s_i^2}{\Delta t^2} \quad (3.2)$$

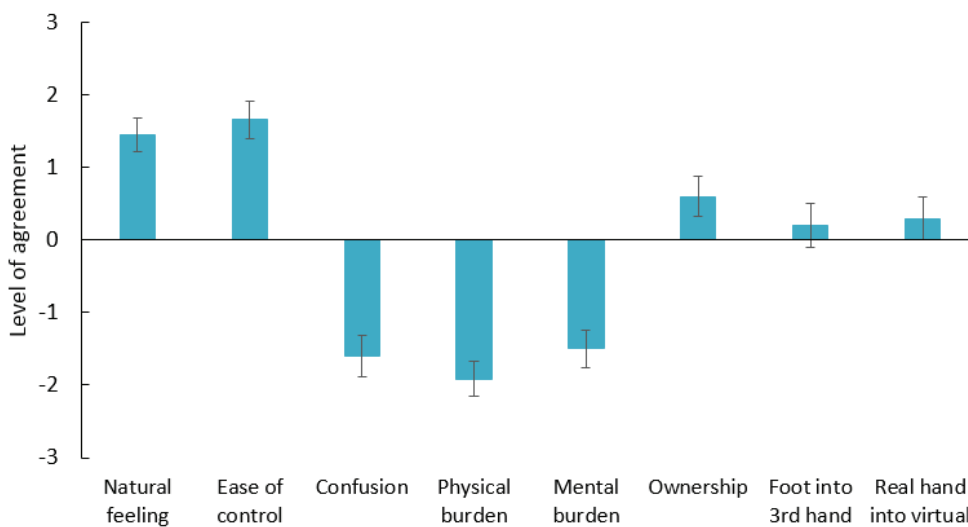
The average work per mass of the two and three-handed scenarios were similar, with a small difference of 3%. Figure 3-12 presents the work performed in each game round and control strategy. In the second game round, the effort in the three-handed scenario was 16% larger than that of the two-handed scenario but the difference was not significant. In the third and faster game round the work per mass of the three-handed scenario was 30% less than that of the two-handed one which is a significant difference ( $p<0.001$ ,  $z=3.4381$ , rank sum test).



**Figure 3-12 Work performed in each game round in the two-handed and three-handed scenarios.**

### Subjective Assessment

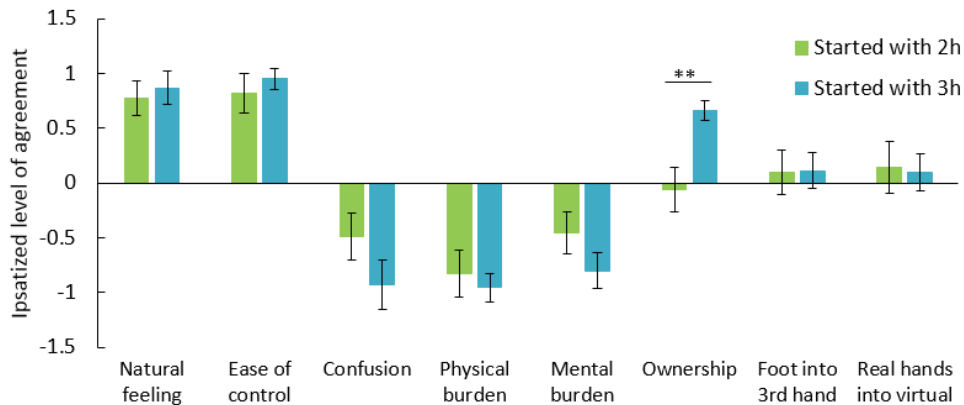
Figure 3-13 illustrates the results of the questionnaire about the three-handed control strategy over all the subjects. The differences between the responses of those who started the experiment with the two-handed game and those who started with the three-handed one are reported along with the global results (Figure 3-14). To obtain a more accurate comparison between the two groups, the data from each question were standardized using an ipsatization procedure. Ipsatized data account for uniform response biases [100], i.e. participants' answers will be ranked according to their personal understanding of the rating scale. It was calculated by subtracting the mean rating of all the responses of a subject from each of his or her responses and dividing it by the standard deviation (SD) of the subject's responses in all the questions. It is indicated in the text wherever the ipsatized data is reported.



**Figure 3-13 Average response of all the participants to the questionnaire of Table 3.1. -3: Strong disagreement, +3: Strong agreement.**



### 3 Performance Comparison between Two-Handed and Three-Handed Manipulation in a Demanding Task



**Figure 3-14 Ipsatized mean questionnaire ratings for those who started with 2h and those who started with 3h.**

Subjects found it natural to control three hands simultaneously (Q1, mean response: 1.5 on the range  $[-3, 3]$  with 0 as mid-range value). Those who started with the three-handed game found it more natural to control the third hand by foot compared to those who started from the two-handed one but the difference is not significant. It has also been easy for the subjects to control the third hand by foot (Q2, mean response: 1.7). Those who started with the three-handed game found it slightly easier. Participants were not confused by the number of tasks they had to perform at the same time with three virtual hands (Q3, mean response:  $-1.6$ , where  $-3$ =least confusion). Those who started with the three-handed game have reported slightly less confusion (not significant), indicating that doing the same task with two hands did not result in participants feeling more comfortable in the three-handed strategy. Physical and mental burdens are low (under  $-1.5$ ) for the whole sample (Q4 and Q5).

Participants were almost neutral about having sense of ownership towards the third hand (Q6, mean response: 0.6). However, those who started with the three-handed experiment had an average ipsatized response of 0.66 which is significantly higher ( $p < 0.004$ ,  $t = -3.1765$ , t-test) compared to those who started with the two-handed game with an average ipsatized response of  $-0.06$ . Not only do these results indicate that performing a task with two hands before the three-handed experiment does not help the participant feel more comfortable in the three-handed game, but it also produces an unwanted reference which negatively influences the user's perception of the three-handed task.

Subjects did not feel that their foot was turning into the third arm (Q7). Mean answer for all the participants to the corresponding question is 0.2, indicating that the sense of ownership towards the third hand is not as a replacement of an existing limb (here the foot) but it is perceived as a virtual supernumerary limb. Answers to the control question were independent of the succession of the games and it was almost neutral (Q8, mean response: 0.3), illustrating that subjects did not feel that their real hands

were turning into virtual limbs. We expected negative or neutral answers to this question indicating that subjects have not answered the questions in a random manner.

The comparative questionnaire revealed that the three-handed game was better accepted in every sense (Figure 3-15). 69% of the participants found the three-handed game easier for catching three objects and 77% preferred the three-handed strategy for this game indicating that if a task demands more than two hands, subjects are willing to use more hands to perform the task. 29% of subjects found the two-handed game physically more tiring, 20% reported that the three-handed game was more tiring and 51% thought none of the games were tiring. 43% of participants thought the two-handed game was mentally tiring, 34% thought three-handed game was mentally tiring and 23% said that none of the games were mentally tiring. The responses to the last two questions show that the added effort for catching the middle object with one of the two hands is mentally and physically more demanding. The smaller physical and mental burden for the three-handed game also explains why it is preferred and found easier.

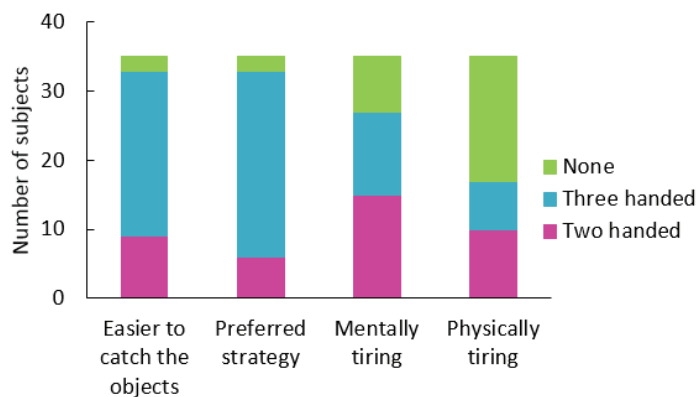


Figure 3-15 Response of participants to the comparative questionnaire of Table 3.2.

### 3.4 Discussion

An experimental study was conducted to analyze and compare humans' performance in doing a demanding task with two or with three hands. The experiment was carried out in virtual reality where the third hand was controlled by the right foot. The virtual hands were controlled by motion of the real hands and the foot tracked by two Kinect cameras [101].

Previous studies have typically investigated the factors influencing the bimanual or one hand and one foot coordination [102, 103]. To our knowledge, the present study is the first on bimanual versus three-handed manipulation performance in which the two hands and one foot perform similar tasks simultaneously and independently.

### 3 Performance Comparison between Two-Handed and Three-Handed Manipulation in a Demanding Task

---

The two hands moved at similar velocities on average, while the foot always moved faster than the hands. This shows that the foot interface should compensate for the faster and jerkier foot movements in order to control a robotic arm with the same speed characteristics as biological arms. This ultimately may help coordination of the three arms. The three limbs were moved simultaneously in less than 10% of the time through the game rounds. This shows that performing three independent tasks with three limbs is not achievable within a few minutes of practice and it is not the best approach to multi-limb applications. The two hands had more simultaneous movement compared to one hand and one foot. Ipsilateral hand and foot had the least simultaneous movement among all the possible combinations of the limbs. It is known that ipsilateral limbs have the most inaccurate simultaneous movements in opposite directions [104]. We believe this is the reason they were voluntarily less likely to be chosen for simultaneous actions in our experiment. Interestingly, the time in which the foot was used together with one or the two hands increased uniformly over the game rounds. Although the task in this experiment can be completed by sequential movement of the limbs, more objects could be caught by simultaneous usage of limbs. The increase in simultaneous movements through the game rounds proves that subjects adopted a more efficient strategy within a few minutes of practice. Limbs started their movement simultaneously i.e. there was no preference in the sequence of moving the limbs for the first time in the game. A previous study on dual, driving like, simultaneous and independent task of the two hands and one foot has shown that attention to concurrent reaching with hands and foot pedal tracking is flexibly allocated based on task structure and priority [105]. The present study shows that proposing carrying out the same task for the limbs results in a parallel non-prioritized control of the limbs. The working space as well as the distance travelled by each limb were inversely proportional to the movement velocity in each game round. It shows that the more demanding the task, the more attention is devoted to performance efficiency i.e. minimizing the path between the hand and the target object. The participants used different performance strategies; some of them actively moved their limbs through the game, while others tended to optimize their performance by minimizing their movements. The individual differences are also illustrated in the subjects' efficiency e.g. the number of caught objects, the time required to complete the game and the pinching accuracy. As a result, a global instructional program for using the third hand should be backed up with a study on the performance of a large sample to make it suitable for every user.

On average over all the participants and conditions, there was no significant performance difference between the two control strategies. However, at maximum game speed, objects were lost twice as frequently in the two-handed as in the three-handed game. This shows that the three-handed control is more effective once the task becomes more demanding. A previous study on hands-foot coordination in gaming, reports less cognitive burden in independent tasks [106], however they

proposed different tasks for the hands and the foot. Subjective assessment in the current study, which consists of independent but similar tasks for all the limbs, shows that participants found the three-handed control strategy natural and were not confused by the paradigm. They found it easier to play the game with three hands and preferred this strategy, reporting less physical and mental burden. The preference of the control paradigm did not depend on the effort used in each strategy, as the effort was almost the same for both.

Two minutes of practice was not enough for developing the sense of ownership towards the third hand. In our other experiment with three different virtual games (presented in Chapter 4) [107], we observed that the sense of ownership towards the third hand improved constantly through the games. Also, performing different types of three-handed tasks may enhance the ownership. Comparing the performance of the participants in that experiment and the one presented in this chapter, we can see that in the previous experiment only an average of 1.5 objects were missed in each game whereas in the current experiment an average of 3.5 objects were missed. The average required time for completing the same game in the previous experiment was 9% less compared to the current experiment. These results highlight the effect of practice. The performance of participants improved significantly once they received a few minutes of practice with other games which needed three hands before they actually played the falling objects game.

In the current experiment, starting with the two-handed game did not improve performance significantly relative to subjects who started directly with the three-handed game. This indicates that performing the same task with two hands does not help in mastering the three hands paradigm.

The main limitations of this experiment are the sample group and the task type. Most of the subjects were students, thus younger than a typical surgeon and with an engineering background. Also the task is not comparable to a surgical manipulation. Therefore, the present results cannot be applied directly to a surgical situation. Further testing will require involving surgeons and tasks closer to surgical gestures. However, it provides strong evidence of the usefulness of a third arm in demanding tasks from surgical to industrial application.

## 3.5 Conclusion

Hands-foot collaboration is widely used in tasks such as driving (vehicle control), playing certain musical instruments and more recently in gaming. To our knowledge this is the first study on the simultaneous usage of the two hands and one foot for cooperative tasks. This chapter provided a comparison of performance during the same task carried out with two and three hands. The results show that in the selected three objects reaching task, subjects preferred to use three hands. They

### 3 Performance Comparison between Two-Handed and Three-Handed Manipulation in a Demanding Task

---

found it easier to complete the task with three hands and reported lower mental and physical burdens than when two hands were used. In fact, from the objective measure of caught objects, we learned that in the most demanding task (fastest game speed), the participants performed better with three hands. This demonstrates that a third arm can improve performance in applications that involve handling multiple tasks in a short period of time.

This study casts light on the users' approach to the three-handed control as compared to the two-handed one. The findings prove a high potential in using the foot to become more autonomous in surgery as well as other fields.



# 4

## Coordination in Three-Handed Manipulation

### Summary

In the operating theater, the surgical team could highly benefit from a robotic supplementary hand under the surgeon's full control. The surgeon may so become more autonomous; this may reduce communication errors with the assistants and take over difficult tasks such as holding tools without tremor. In this chapter, we therefore examine the possibility to control a third robotic hand with one foot's movement. Three experiments in virtual reality were designed to assess the feasibility of this control strategy, the learning curve of the subjects in different tasks and the coordination of the foot movement with the two natural hands. Results show that the limbs are moved simultaneously, in parallel rather than serially. Participants' performance improved within a few minutes of practice without any specific difficulty to complete the tasks. Subjective assessment of the subjects indicated that controlling a third hand by foot has been easy and required only negligible physical and mental efforts. The sense of ownership was reported to improve through the experiments. The mental burden was not directly related to the level of motion required by a task, but depended on the type of activity and practice. The most difficult task was moving two hands and foot in opposite directions. These results show that a combination of practice and appropriate tasks can enhance the learning process for controlling a robotic hand by foot.

The findings of this chapter were published in the PLOS ONE journal with the following authors list: Elahe Abdi, Etienne Burdet, Mohamed Bouri and Hannes Bleuler. Elahe Abdi designed and performed the experiments, analyzed the results and wrote the manuscript under the supervision of Etienne Burdet, Mohamed Bouri and Hannes Bleuler: E. Abdi, E. Burdet, M. Bouri, and H. Bleuler, "Control of a Supernumerary Robotic Hand by Foot: An Experimental Study in Virtual Reality," *PLoS ONE*, vol. 10, p. e0134501, 2015.

### 4.1 Introduction

Following Chapter 3, in which the advantage of a three-handed control strategy in a demanding task was proven, in this chapter, the proper level of difficulty of the tasks is evaluated. We designed a set of experiments in virtual reality to analyze the learning curve of the subjects and to check whether the subjects move the limbs serially one after the other, or in contrary control them in parallel. This is completed by a subjective assessment of the development of sense of ownership towards the third hand, the physical and mental load of using the foot for commanding a third arm.

These questions are investigated on three tasks (implemented as *games*) of varied difficulty involving three hands commanded by the natural hands and a foot. A first game studies the possibility of controlling three hands to complete a simple task, namely displacing the hands to predefined targets. The second game investigates the capability of humans in moving the foot simultaneously with and independently of the two hands, similar to typical surgical situations where the third hand should complement the actions of the two intrinsic hands. The last game involves more active movements and subjects have to pay attention to multiple factors during the game. This is to study humans' approach to multiple tasks management using three hands. While we refer to a surgical situation, the present study is to check the general feasibility of controlling a third arm with a foot.

### 4.2 Methods

#### Experiment

Thirteen subjects (two females) with mean age of  $24\pm 3$  years participated in the experiment. The experiment was approved by the BMI Ethics Committee for Human Behavioral Research at EPFL, and each participant gave written informed consent prior to the experiment. An experiment was developed to investigate how subjects coordinate the three virtual hands to complete a task. Two of the virtual hands move with the user's real hands and the third is controlled by the right foot. Three tasks or games were designed to address specific questions. The difficulty level of a game could be controlled by the progression of skills and the mix of challenges [108]. The level of difficulty of each task is judged by the amount of motion of the two hands and of the right foot. Each of the three games is played twice.

#### Setup

The setup of this experiment is the same as the one introduced in Chapter 3. The experiment is designed as a virtual game played with three virtual hands. Two virtual hands move on a computer monitor according to the movements of the two



real hands of the player, while the third virtual hand is controlled by the player's right foot, i.e. the third hand trajectory on the monitor corresponds to the foot's planar movement on the floor. Two Microsoft XBOX 360 Kinect© depth cameras are used, one for tracking the movements of the player's two hands and the other one for the foot. The SDK of the 3Gear Systems Company, which includes a library of predefined hand gestures, has been used to track the finger motions of the real hands. Each SDK supports only one camera, consequently a network of two computers have to run in parallel to render three virtual hands in real-time.

### First game

The first game examines the efficacy of controlling a third hand by the foot simultaneously to the two hands. Three rectangular targets appear on the screen on a horizontal line, as well as three virtual hands (Figure 4-1). The left and right hands have to touch the left and right rectangular targets, respectively. The middle rectangle can be touched with the (yellow) foot-controlled hand. The "touch" is defined as a brief contact between the hand center and the object. Each target is sensitive only to its allocated hand, i.e. touching an object with a wrong hand will have no effect. The aim of this game is "to touch all the three targets simultaneously and as fast as possible". If the time elapsed between touching the first and the last object is less than four seconds, this is interpreted as a success and the message "You won! ☺" appears on the screen. Otherwise, the message "Try again!" will show up, indicating a failure. The moment at which each object gets touched, is recorded as well as the success or failure in each trial.



Figure 4-1 First game: Right: Three rectangular targets and three virtual hands, Left: Automatic messages after success or failure.

### Second game

The second game studies the simultaneous control of the two hands in a direction opposite to the foot. Again, three rectangles appear on the screen, with a set of three arrows showing the desired direction of movement of each rectangle (Figure 4-2).

The arrows indicate that the rectangles on the left and right sides should move in the same direction and the middle rectangle should move in the opposite direction. Each rectangle can be moved only by the respective hand. The task consists in moving the three targets in the correct direction simultaneously for at least three seconds. Once the goal is reached, the three arrows change so that the user has to move each rectangle in the opposite direction. Two sets of arrows are used in the game, which appear twice on the screen one after another, resulting in a total of four rounds per game. For each participant, the time required to complete the game is recorded. Note that many other combinations of the hand-foot simultaneous movements could be investigated, e.g. one hand and one foot moving in the direction opposite to the other hand. The directions combination selected for this game corresponds to operational situations where the two hands collaborate in performing a task while the foot controlled robotic arm should perform independent, but complementary movements.



**Figure 4-2 Second game: Two sets of arrows which indicate the correct direction of movement of the three virtual hands.**

### Third game

The third game studies the coordination of the two hands and the foot in performing a more complicated task. Three objects fall from the top of the screen, the user has to “catch” them before they reach the bottom (Figure 4-3). The left and right objects have to be caught by pinching with the corresponding (grey) hands while the middle object has to be “touched” with the foot controlled (yellow) virtual hand. When an object is caught successfully, it returns to the top and starts falling again. The speed of the objects increases after each of them has been caught at least three times. Only three levels of speed are used: Once the maximum speed is reached, it will remain constant regardless of the number of objects successfully caught. If the user fails to catch four objects, the game will be terminated with a failure message. If every object is caught three times at the maximum speed level, the game will terminate with a success message. Every subject played the three games in the above order and each game was played twice.

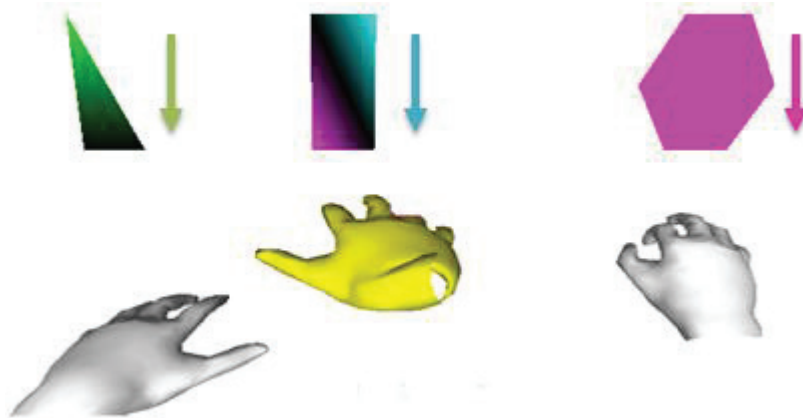


Figure 4-3 Third game: Each of the three falling objects should be caught by the corresponding hand.

### Assessment

Our assessment of the subjects' performance is based on the time required to successfully complete a task. In the third game, the number of missed objects is used as an additional measure of efficiency. The assessment is completed by a questionnaire about different aspects of the control strategy, which is filled after each game. The three games are played in the same order as described above. The questionnaire consists of grading the statements of Table 4.1 using a Likert scale, from 1 (for "strong disagreement") to 5 (for "strong agreement"). Participants also answer the two comparative questions of Table 4.2 when the whole experiment is completed.

Table 4.1 Common questions for all the three tasks.

Questionnaire statements	
Q1	It felt natural for me to control three hands simultaneously.
Q2	It was easy for me to control the third hand by foot.
Q3	I felt as if the virtual third hand was my own.
Q4	Playing the game was physically tiring for me.
Q5	Playing the game was mentally tiring for me.

Table 4.2. Comparative questions for the three games.

Questionnaire statements	First game	Second game	Third game
Q1			
In which experiment was it easier for you to control the third hand? (Put the maximum 3 for the easiest)			

Which experiment helped you more in mastering the Q2 simultaneous control of three hands? (Put the maximum 3 for the most helpful)

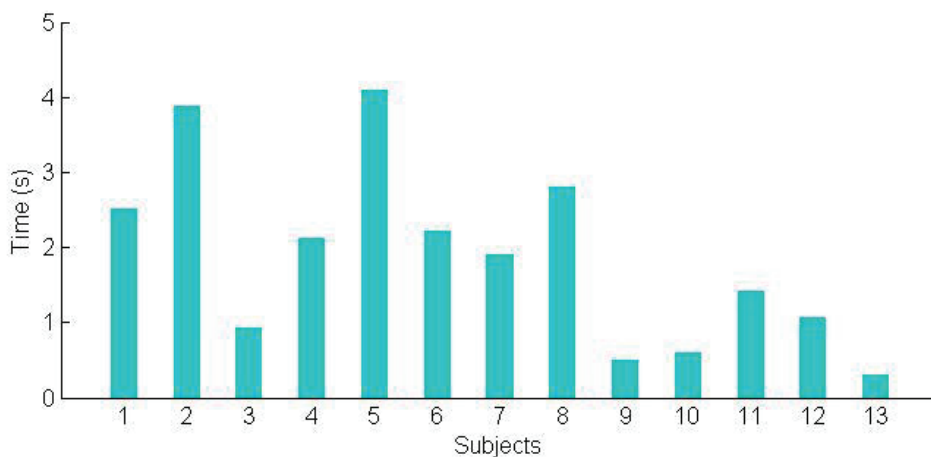
---

### Statistical Analysis

Normality of the data sets was checked using the Jarque-Bera test. For normally distributed data sets a t-test was used to identify significant differences between different sets, with significance level  $p < 5\%$ . The nonparametric Wilcoxon signed rank test was used to analyze the differences between two non-normally distributed data sets. Standard deviation is presented through the text and in the diagrams.

### 4.3 Results

The first game was successfully completed by all 13 subjects. Nine subjects succeeded in all trials and four failed once. To infer performance we consider the coordination time between touching the first and the last rectangles. The average coordination time over the subjects and two trials of  $1.87 \pm 1.14s$  indicates a good coordination of the three virtual hands. However, Figure 4-4 exhibits a large variation between the mean coordination times of different subjects (with a 10 fold duration variation between some subjects). This presents important individual differences in the ability to simultaneously control three limbs between the subjects.



**Figure 4-4 Average performance time for each participant for the first game.**

Participants were free to choose the sequence of touching the rectangles i.e. a subject could start with touching the right rectangle, then continue with touching the left rectangle and the middle one or they could choose any other sequence. Figure 4-5 shows the distribution of times to reach the three targets. A first hypothesis is that to simplify computation of the movement, the subjects would move the virtual hands in a definite order. If the movements of the three hands would be carried out serially,

we would see separated distributions of the arrival to each target. In contrast, the overlap of the temporal distributions of reaching the three targets shows that there is no priority in the sequence of limb actions, and the movements of the three limbs are carried out in parallel.

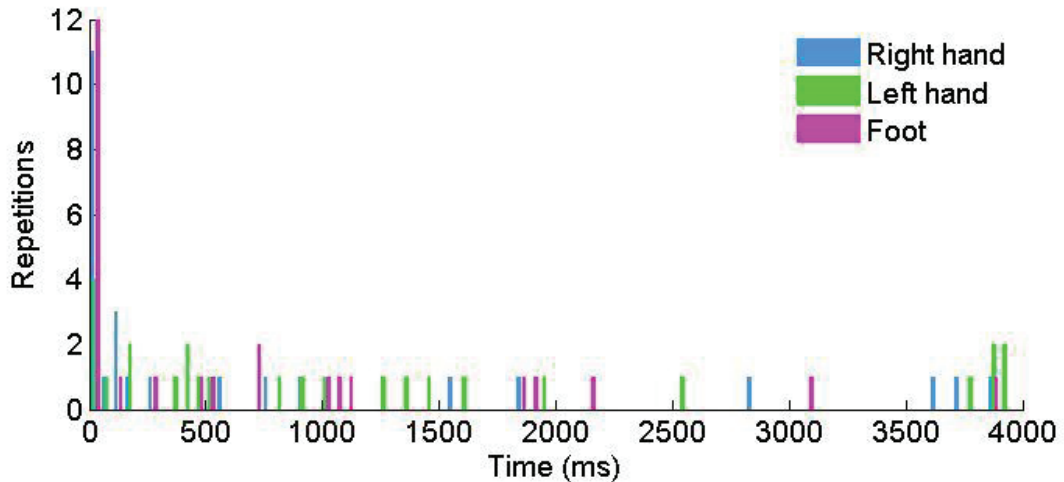


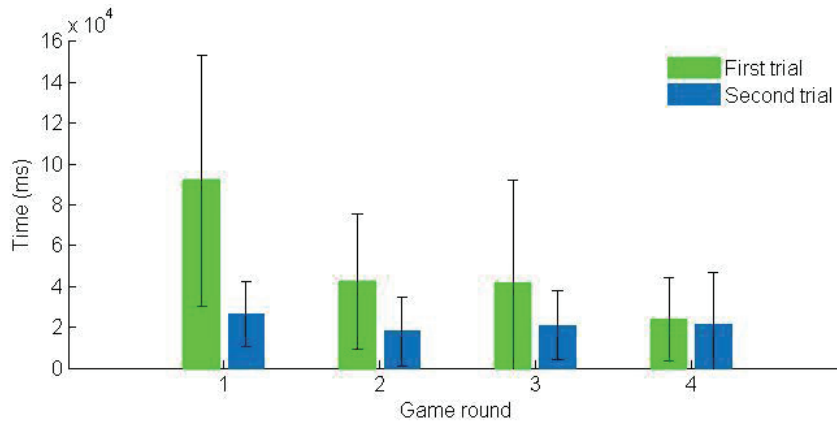
Figure 4-5 Histogram of the time to reach the three targets. (0ms corresponds to the time of reaching the first target.)

The action most frequently started with the foot movement (42% of times) and the right hand (38%) and least frequently with the left hand movement (20%). Also the right (dominant) hand was used before the left hand in 64% of times, while the probability in random selection is 50%. The average coordination time was on average 14% shorter in the second as in the first trial; however this difference was not significant.

Another hypothesis was that people would see their real hands as one group and the third hand as a separate tool. Consequently they would touch the targets that correspond to their two real hands one after another, either after or before touching the middle target by the foot controlled hand. This was again tested by recording the moment at which each target is touched. Six different conditions are possible for the succession of the two hands and foot for touching the targets, in two of which the foot is moved after one hand and before the other. Meaning that if the limbs are moved randomly, in  $2/6=33.3\%$  of times the hands are not moved in a row. Results show that in reality the foot comes between the two hands in 31% of times, which is close to random.

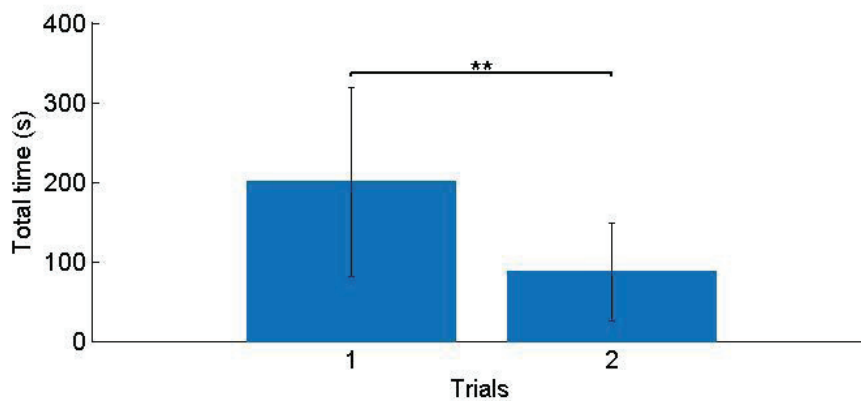
In the second game participants had to move three objects, with the foot's rectangle in opposite direction to the two hands' objects. This corresponds to typical medical interventions where the two hands work on an operation together and the foot controlled third hand should assist. The game has four rounds, two for each of the two predefined directions. The whole game was played twice. The results show that

the subjects required a significant time to keep the three hands in the correct direction (Figure 4-6). However the required time for completing each round decreased through the four game rounds to approximately 20 seconds. Also the allotted time in the second trial was less in all the respective game rounds.



**Figure 4-6 Second game: Average allotted time over the subjects in four rounds of two trials.**

Statistical analysis shows that the performance time was longer in the first versus the second run of the game ( $p < 0.003$ , Wilcoxon signed rank test) (Figure 4-7). The marked decrease in the required time for completing the game suggests that the users' performance improved significantly within a few minutes of practice.



**Figure 4-7 Average total performance time in the first and the second trials ( $p < 0.003$ ).**

The third game tested a more complicated coordination task as the first game. The results again exhibit a significant performance time decrease in the second trial as compared to the first trial (Figure 4-8 and Figure 4-9,  $p < 0.014$ , Wilcoxon signed rank test). However, here the time difference between the three rounds of the same game was also due to the increase in the falling speed of the objects corresponding to faster operation. Most of the subjects were successful in catching the falling objects. An

average of 2.83 objects was lost in each trial, i.e. about 10% of the objects. The user performance again improved within few minutes of practice.

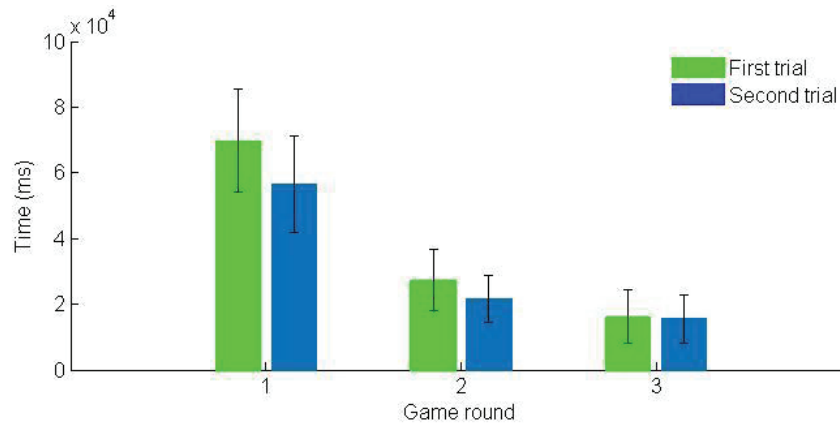


Figure 4-8 Third game: Average allotted time over the subjects in three rounds of two trials.

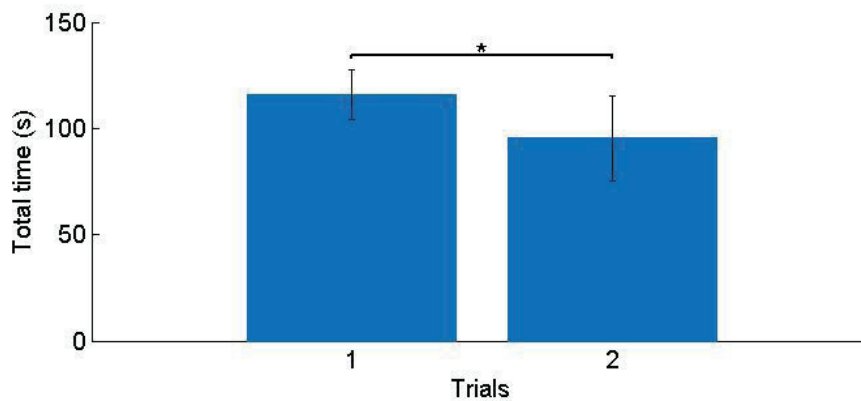


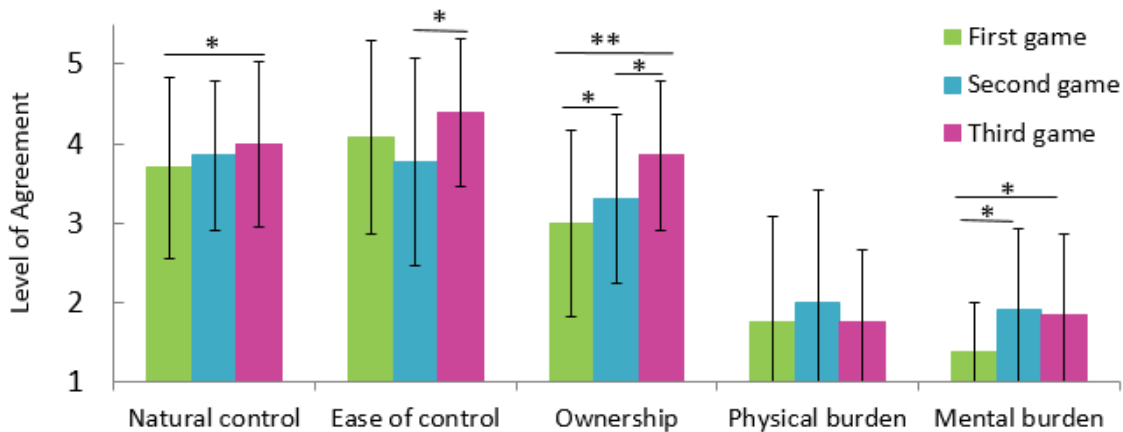
Figure 4-9 Third game: Average total performance time in the first and second trials ( $p < 0.014$ ).

### Subjective Assessment

The results of the questionnaire about the control of the third hand are illustrated in Figure 4-10. We see that the simultaneous control of three hands starts to feel more natural as the user advances from the first to the third game. In particular it feels significantly more natural in the third game compared to the first one ( $p < 0.040$ ,  $t = -2.309$ ,  $t$ -test). Also it has been significantly easier for the subjects to control the third hand by their foot in the third experiment compared to the second one ( $p < 0.014$ ,  $t = -2.889$ ,  $t$ -test). This may be due to the chronological order of the experiments; as the third game comes last, users have already gained some experience during the previous two games and they feel more at ease in the third game. However, controlling the third hand was hardest in the second game, although the third game is more dynamic and in spite of the fact that users have gained some experience in

the first game. This shows that apart from practice, task type may influence participants' evaluation of the ease of an activity.

The participants generally found the physical burden low, although two subjects mentioned that it had been tiring. Mental burden was found to be low. It was lower for the first game compared to the second ( $p < 0.016$ , Wilcoxon signed tank test) and the third ones ( $p < 0.04$ , Wilcoxon signed rank test).



**Figure 4-10** Average response of all the participants to the questionnaires for each of the three experiments. Statements are ranked through 1 to 5 (1: Strong disagreement, 5: Strong agreement). \*:  $p < 0.05$ , \*\*:  $p < 0.01$ .

The sense of ownership does not follow exactly the reported ease of the task, i.e. the sense of ownership constantly increases from the first to the second and the third game. This improvement of the sense of ownership is significant between each two combinations of the games (first vs. second game:  $p < 0.04$ ,  $t = -2.309$ , t-test; second vs. third game:  $p < 0.013$ ,  $t = -2.941$ , t-test; first vs. third game:  $p < 0.003$ ,  $t = -3.811$ , t-test) indicating the strong effect of practice in developing the sense of ownership. Considering the short period of practice during the games, this reveals that ownership of the third hand can be developed to a satisfying level within a few minutes of active usage of the virtual hand.

At the end of the whole experiment, participants compared the three games with respect to the ease of control of the third hand. They had first to select the most difficult and the easiest game (Figure 4-11). 10/13 participants stated that they have controlled the third hand more easily in the third game. Also 10 participants found the second game the most difficult one, which may indicate that the least difficulty of the third game does not stem from practice with the two first games. These results are in agreement with those of the dedicated questionnaires for each game.



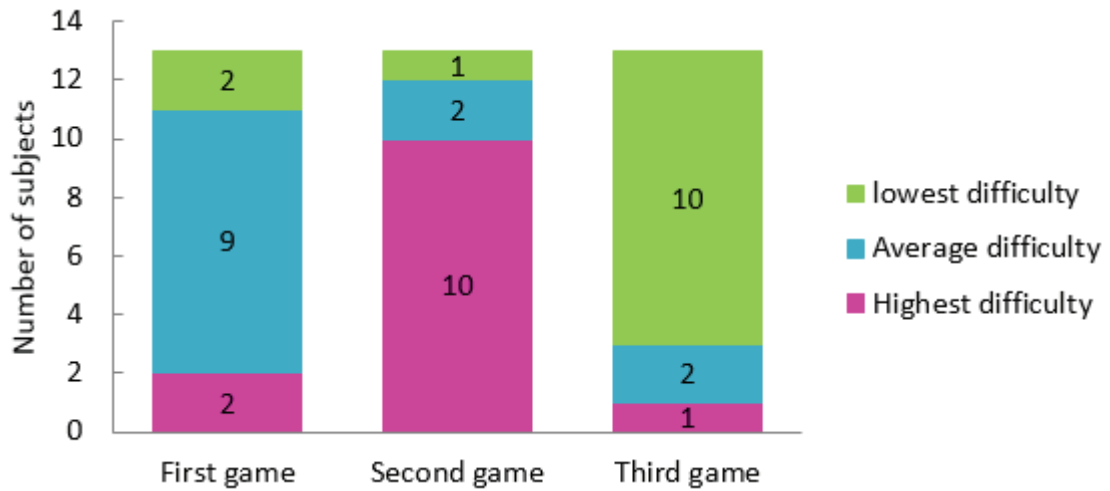


Figure 4-11 Comparative question: “In which experiment it was easier for you to control the third hand?”

All users found the third game the most helpful one in mastering the simultaneous control of three hands. They put the second and the first experience in the next levels (Figure 4-12). Although the only game in which they were obliged to move all the three hands simultaneously was the second one, subjects found the third one more helpful in learning simultaneous control of three hands. This may mean that dynamic games with more interesting interfaces may be more effective in developing control skills.

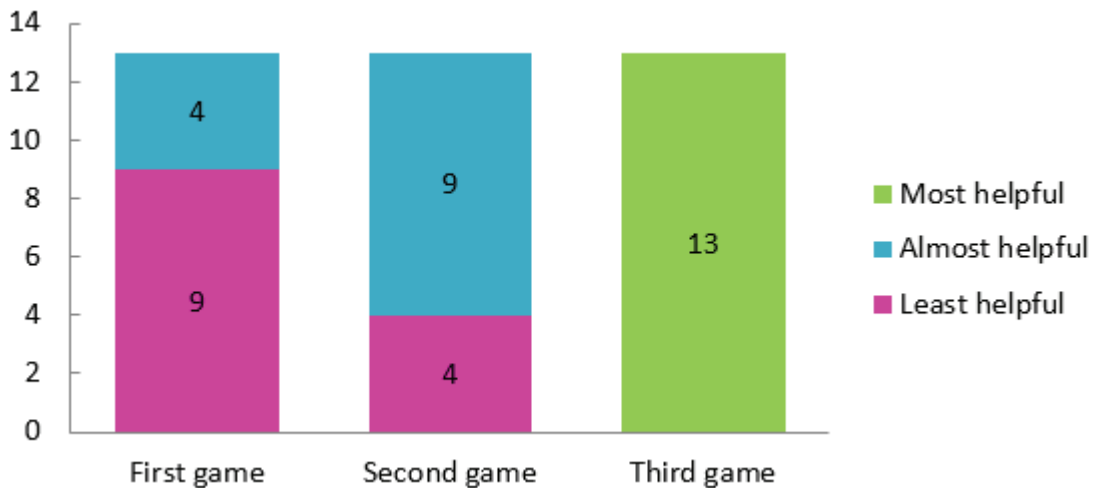


Figure 4-12 Comparative question: “Which experiment helped you more in mastering the simultaneous control of three hands?”

### 4.4 Discussion

An experimental study was conducted to evaluate the feasibility of controlling a third virtual hand by foot simultaneously with two virtual hands commanded by the real hands. Three games were designed to investigate the control of the three hands in situations abstracted from typical surgical operation conditions. The performance of the participants was assessed through monitoring their actions as well as from their answers to questionnaires filled after each experiment.

The results of the first experiment to study the simultaneous control of the three hands showed that participants used the three virtual hands without any specific priority i.e. not in a predictable sequence. This parallel control of the three hands proves that the subjects integrated the third hand in their action as an equivalent of their two real hands.

The other games investigated performance time when i) the foot-controlled virtual hand was carrying out a different but complementary task to the two hands (second game) and ii) the three hands worked simultaneously on a dynamic task (third games). In both games the performance time decreased significantly within a few minutes of practice, which indicates a rapid learning effect. This demonstrates that the subjects had no specific difficulty in learning to control the third hand with the foot and coordinating it with the two intrinsic hands.

The chronological order of the games was set from the one with least required motion to the one with highest amount of motion. However, the last game was reported as the easiest one for controlling the third hand by foot, the one with the most natural feeling and offering maximum sense of ownership towards the third hand.

Going through the responses to the questionnaire, another effect is also detectable: the influence of task type in the performance of the subjects and their feeling towards the control paradigm. Although participants get familiar with the setup during the first game, and the third game is supposed to be more difficult due to higher necessary amount of motion, they found the second game clearly more difficult compared to the first and the third games. This shows that apart from the experience, the task type also affects the approach of the subjects.

In the second game, the subjects were forced to move the foot-hand in opposite direction to the two hands. According to their comments, this makes the second game difficult, which corresponds to the relatively large time they need to carry out this task. This is in agreement with previous studies showing inaccuracy in the movement of one hand and one foot in opposite directions [102, 104]. On the other hand, the third game was more dynamic and more interesting which helps the participants in performing the task. Also in the first and the last games people were free to choose the sequence of their actions. Most of the participants could easily

handle the multiple tasks of the third game. This hints at a large potential capacity of the human brain in multiple task handling. On the other hand, it was easiest for the participants to control the third hand by foot in the third game. They had more sense of ownership towards the third hand and they felt that it helped them more in mastering the simultaneous control of three hands. These results suggest that a combination of practice and appropriate tasks can enhance the process of learning to control multiple limbs simultaneously.

We note that the three proposed tasks were designed to investigate some basic questions about the control paradigm e.g. possibility of simultaneous control of three limbs, physical and mental burdens, but are no real surgical tasks. In addition, the experiment carried out involved a single session of three games, whereas it has been proven that the learning curve reaches a plateau after adequate number of sessions [109]. It would be interesting to study the learning curve of the subjects during multiple consecutive sessions for determining the total time required to reach the maximum possible level of expertise in controlling the third hand by foot. Also, subjects' sense of ownership towards the third hand was assessed only through questionnaire. Other methods such as electrodermal activity could be used to assess the sense of ownership of the third hand in a more reliable and graded way.

Participants to our experiments were all high school or university engineering students, which may behave differently than surgical staff with different mean age and educational as well as professional background [110, 111]. In general, the present study shows the feasibility of the controlling a third hand using a foot, which may be tested with specific tools and the target population of e.g. trained surgeons. The 2D tasks performed in virtual reality missed the third spatial dimension and the force feedback present in real life. Therefore, an experimental setup with these features might improve the embodiment and result in a better control of the third arm. Using the foot movements can be used to control more than two DoFs (taking its rotational degrees of freedom into account), and many tasks in fact involve few degrees of freedom. For instance typical laparoscopic surgery's tools have only four DoFs.

### 4.5 Conclusion

Although robotic arms have been commercialized for simple assistive surgical tasks such as holding the endoscope in laparoscopic surgery, they are generally controlled in a few discrete actions. In contrast, we studied the continuous control of a third arm, using foot movements. However there is little published literature on the possibility of using a foot controlled supernumerary hand along with the two real hands for complex manipulation.

The results show that within a few minutes of practice the system's users feel the control paradigm natural and easy. Only small physical and mental efforts were reported through the whole experiment, with an increasing sense of ownership towards the third hand. No specific order was detected in the movement of the limbs, indicating that the third hand controlled by the foot would come at a similar hierarchical level as the two hands. The level of difficulty of the task depended on the nature of the task as well as on the amount of practice received, and not directly on the amount of motion required during a game.

These results reveal the possibility of commanding a robot by foot for collaborative actions with the hands with many kinds of applications, from surgeons operating with a robotic assistant to a worker using a robotic assistive device. In the tasks studied here subjects adapted fast to controlling three limbs and managed use them for performing tasks which required simultaneous motion. Coordination games such as these only hint at the vast possibility opened up by designing a proper interface and training strategy. This conclusion is also supported by the level of skill reached e.g. by organ players on the pedal keyboard.

## Camera Manipulation Using the Third Hand

### Summary

A robotic arm under the surgeon's own control will make him or her more autonomous and compensate for inefficient surgeon-assistant communication and lack of assistive personnel during certain periods. Holding the endoscope during laparoscopic surgery is a common example of the long lasting and repetitive tasks of assistants during surgery. Is it possible for the surgeon to control the movements of the endoscope by foot and perform a task with the hands? We conducted an experimental study in a virtual environment with thirty surgeons and medical students. Students and residents had the best results with smoother limb movements, best foot-hand coordination and more usage of the foot for moving the camera. Residents adapted the most positive approach towards foot usage and reported less confusion and mental burden. This suggests that the best period for training the surgeons to use a foot controlled robotic arm is during their residency, when they are aged between 31 to 40 years old.

The findings of this chapter are submitted to the Surgical Endoscopy journal with the following authors list: Elahe Abdi, Etienne Burdet, Mohamed Bouri, Hannes Bleuler and Sharifa Himidan. Elahe Abdi designed and performed the experiments, analyzed the results and wrote the manuscript under the supervision of Etienne Burdet, Mohamed Bouri, Hannes Bleuler and Sharifa Himidan: E. Abdi, E. Burdet, M. Bouri, H. Bleuler, and S. Himidan, "Foot-hand coordination in surgical applications: Residents and junior faculty are better learners than experienced surgeons.," submitted to: Surgical Endoscopy, 2016.

### 5.1 Introduction

As proven in Chapter 4, three-handed tasks are feasible as long as the user is free in choosing the sequence of movements of the limbs and does not have to move them in opposite directions simultaneously. With this background, Chapter 5 investigates the possibility of using a third arm for laparoscopic surgery, where the instruments are inserted into the patient's abdomen through trocars.

In recent years, laparoscopic surgery has become popular as it produces smaller post-surgery scars and less pain for the patient than open surgery, and it can drastically reduce hospitalization time. The endoscope, an instrument through which structures within the abdomen can be viewed, is the omnipresent instrument in this type of surgery. It is held by an assistant for hours during the operation. The abdominal scene captured by the endoscope is projected on the monitor(s) in the operational room, which the surgeon uses to perform the surgery. It is common for the surgeon to ask the assistant to move the camera so that a specific area is exposed in the monitor, then he/she performs a task on the target organ. However, the instructions exchanged between the surgeon and assistant may be ambiguous due to their different relative positions and the projection reducing three-dimensional information. Furthermore, holding the endoscope for long periods of time is difficult for humans but it is unproblematic to use a dedicated device for this operation.

In order to examine the possibility of controlling the endoscope by foot in laparoscopic surgery, we investigate in this chapter the possibility of moving a camera by foot while performing a task with the hands. The experiment is conducted in virtual reality. The task is to catch falling objects with both hands before they reach the bottom of the screen. Once an object is caught it returns to the top and starts falling again. Three objects exist in the virtual environment, however, only one of them is visible at a time, depending on how "the camera is oriented". The virtual camera can be moved to right or left of the scene to bring another object into sight according to the foot movement.

This task was carried out by surgeons and medical students, who are all potential end-users of a foot commanded endoscope, but have different expertise and experience. The performance of these subjects and their opinion about the control strategy were assessed through objective quantitative measures and in a questionnaire. Comparing the performance of participants with different ages, genders, level of expertise, etc. provides a valuable source of information about the necessary trainings for reaching an acceptable proficiency in controlling the camera by foot, as well as on the acceptance of a foot commanded endoscope to carry out surgery.

## 5.2 Methods

### Experiment

Thirty surgeons and medical students with different specialties, age, professional status (i.e. student in medicine, resident acquiring proficiency in a specialty, surgeon attending the operational room after the training period or surgeon with more than ten years of experience), and self-assessed level of proficiency in minimally invasive surgery (Figure 5-1), participated in the experiment. Participants also reported the number of times per week they play video games by choosing one of the following options: never, once a week, or more than once a week. The institutional ethical approval was obtained from the BMI Ethics Committee for Human Behavioral Research. Each subject expressed informed consent, and then participated in the experiment to investigate the possibility of changing the view port by foot (which corresponds to moving the endoscope in laparoscopic surgery) while performing a task using both hands.

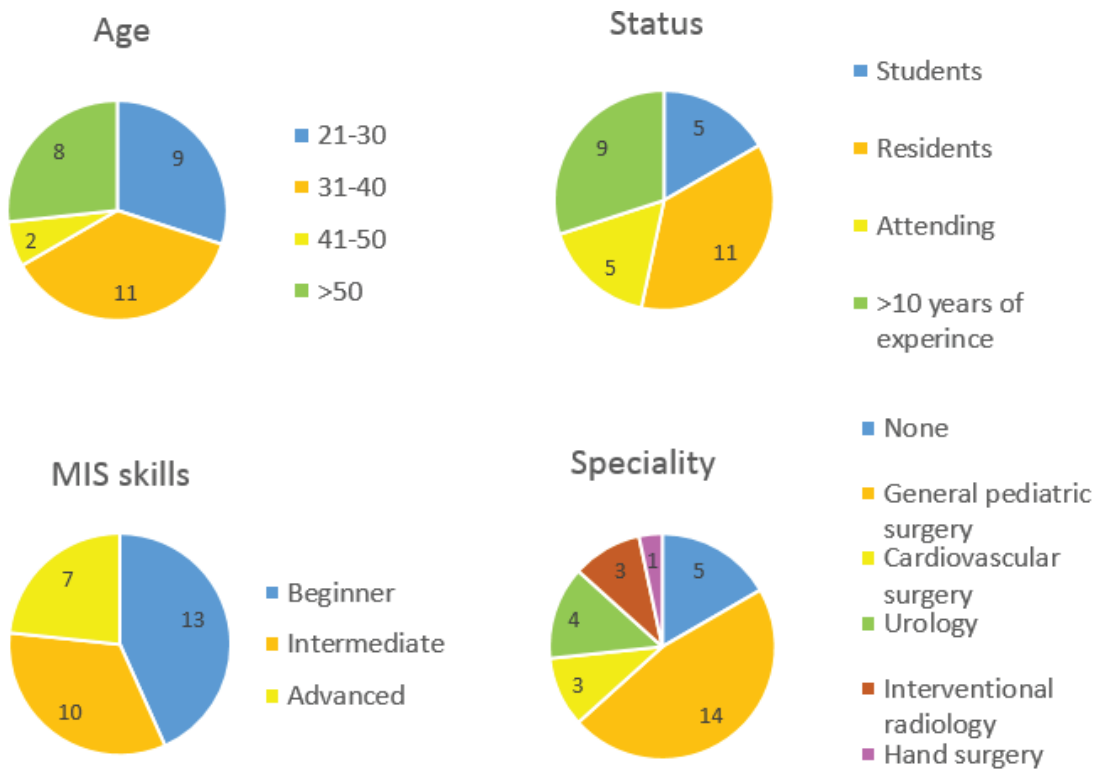


Figure 5-1 Biographical information on the surgeons and medical students who carried out the coordinated control of hands and one foot. Five of the 30 students were female, although the gender was found to not affect the results.

## Setup

Figure 5-2 shows the setup that was used to carry out the experiment. The setup provides only visual feedback of the hands and foot moving in 3D as recorded by two Microsoft XBOX 360 Kinect depth cameras in a network of two PCs. The camera tracking the foot will move the camera in VR in the direction indicated by the lateral movement of the foot. The second camera is tracking the movements of the two real hands of the participant using the SDK of Nimble VR to track the finger gestures of the real hands (fisting, pinching, etc.), which are then displayed on the monitor.

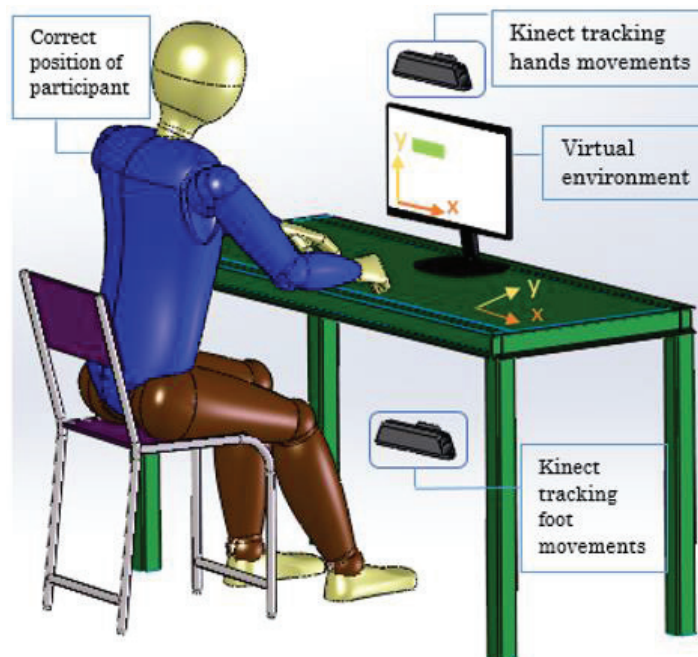


Figure 5-2 Setup with visual feedback to investigate coordinated control of the hands and one foot.

## Paradigm

Three cubes fall from the same height in the virtual space (Figure 5-3). The camera is focused on the central cube which is thus the only visible object on the screen at the beginning of the game. Other cubes, situated on left and right of the central one, can be brought into sight by moving the foot-controlled camera laterally. Lateral movements of the foot result in moving the camera in the same direction e.g. moving the foot to the right brings the camera to the right. Subjects are informed orally of the existence of one cube on each side of the central cube. Planar movements of the user's hands – in a plane parallel to the table's surface – are projected into the planar movements of the virtual hands on the screen. The corresponding coordinate frames of the real and virtual hands' movements are presented in Figure 5-2 and Figure 5-3.



Each object should be “caught” i.e. touched by the two virtual hands with a time difference of less than 4s, before reaching the bottom of the screen. Once a falling cube is successfully caught, it returns to the top of the screen and starts falling again. A good strategy is to move and catch the objects using always the same sequence, e.g. by catching the middle object, then move to right and catch the object there and then to the left and catch the third object, etc. If all the three cubes are caught at least once, the falling speed of all three of them is doubled. A bad strategy (used by some subjects) is to stay on only one object and catch it repeatedly without moving the camera towards other objects. Each trial lasts for 120s. The experimental setup is used twice resulting in four minutes of total interaction time. Subjects had no interaction with the setup prior to the first trial.

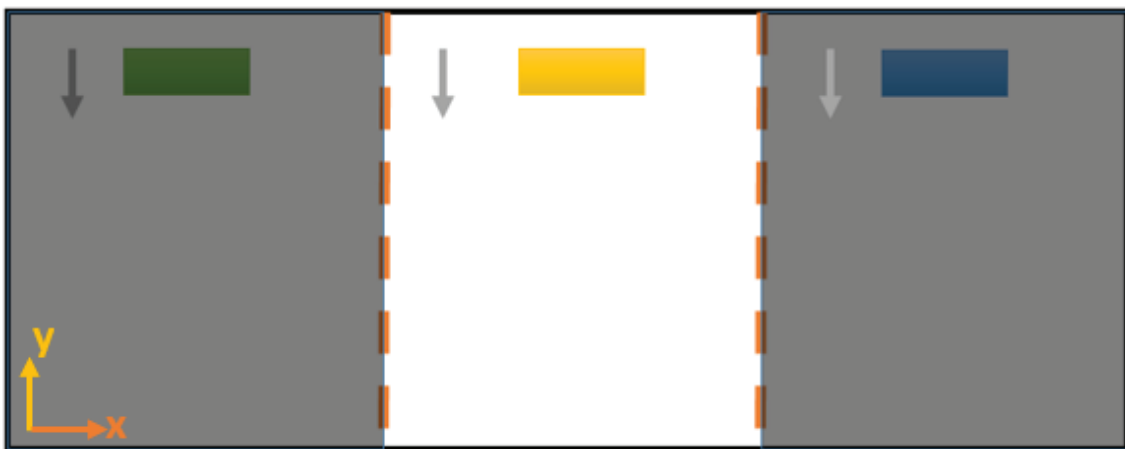


Figure 5-3 virtual environment with foot displacing the visible area. The largest rectangle represents the whole workspace in the task. The white rectangle is the area visible to the user at the beginning of the game. The view can be shifted to right or left by moving the foot in the corresponding direction.

### Assessment

The planar position of the virtual hand representatives and the foot are recorded at a frequency of 5Hz and the movement velocities are then calculated by numerical time derivation of sampled position data. At the end of the experiment, subjects answer a set of questions about their experience as shown in Table 5.1. Each statement is ranked in an ordered response Likert scale, from -3 (for “strong disagreement”) to +3 (for “strong agreement”). The third statement is a control question.

Table 5.1 Questionnaire statements filled out after the experiment.

Questionnaire statements	
Q1	It felt natural for me to move two hands and the foot independently.
Q2	It was easy for me to control the camera by foot.

- 
- Q3** I felt as if my real hands were turning into ‘virtual’.
- Q4** I got confused with the number of tasks that I had to perform simultaneously.
- Q5** It was physically tiring for me.
- Q6** It was mentally tiring for me.
- 

### Statistical Analysis

The measures of performance were averaged across trials for each participant. Results were analyzed with multivariate analysis of variance (MANOVA) with three within-participants factors: age, skill in MIS surgery and status. Significant results were further analyzed using a pairwise comparison. The data sets were checked for normality using the Kolmogorov-Smirnov test [112]. Non-normal data sets were compared for possible significant difference using the rank sum test, and the 2-tailed, paired-sample t-test was used for normal data sets. A 5% significance level was used in these tests. The standard error of the mean (SEM) values are reported through the text and in the plots. The same statistical procedure is carried out for questionnaire ratings.

## 5.3 Results

Participants’ performance and efficiency were assessed using the number of objects caught, motion smoothness, and the number of times the foot is used during the total four minutes of interaction. The period of simultaneous movement of limbs provides additional information on the control strategy used by the participants. Results are not discriminated on the basis of the participants’ specialty as the population of specialists in each field is small. Statistical analysis for performance measures showed that participants’ status had significant influence on the results (Pillai’s trace, value=1.07,  $F=2.43$ ,  $R^2=0.36$ ,  $p=0.007$ ). No such influence was detected for the age, skill in MIS, proficiency in video game and gender factors. The detailed performance comparison of the subgroups of each factor for different performance measures are presented in the following subsections.

### Caught Objects

An average of  $5.3 \pm 0.4$  objects are caught. Residents caught  $6.4 \pm 0.7$  objects, the highest on average among all the groups (Figure 5-4). More than one object was caught from the same position before moving the camera to another position in 49% of the time. This means that once an object was caught successfully and started falling again from top of the screen, some participants preferred to stay in the same place and catch the falling object from the same position instead of moving the camera to another position and catching another object. However, no pattern was

detected in the order of caught objects. Although the catch accrued if an object was touched by both hands within 4s, in 49% of the times subjects did not use this time allowance and caught the object by touching it simultaneously with both hands.

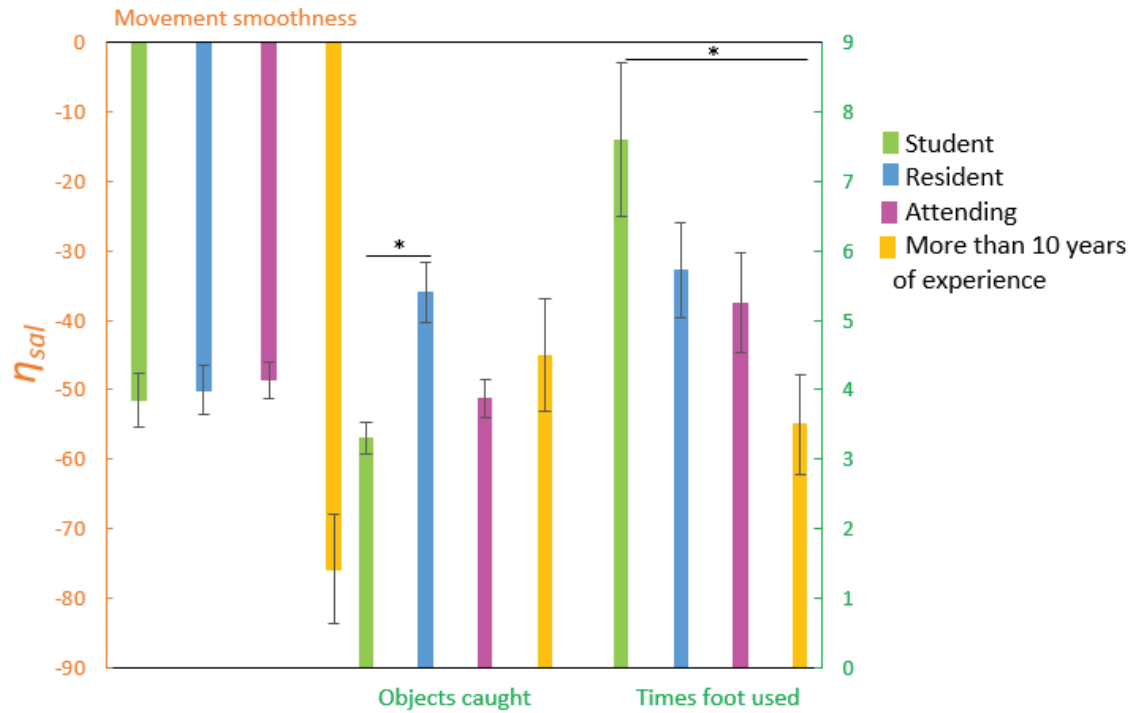


Figure 5-4 Average subjects' performance in visual feedback-only setup on the basis of their medical professionalism.

### Movement Smoothness

The smoothness of the movements of each limb is quantified using the spectral arc length metric ( $\eta_{sal}$ ) [99]. In average over the three limbs, experienced surgeons' movements were the least smooth (Figure 5-4). They also exhibited the least smooth movements for each of the three limbs compared to other subjects' populations. Specifically for the foot, the movements of experienced surgeons were twice less smooth compared to students and residents. This difference was significant for left hand in comparison with attending surgeons ( $p < 0.05$ , rank sum test). Also, participants aged between 21 and 40 years had smoother movements in all of the limbs compared to those older than 50 years. It was significant for the left hand ( $p < 0.02$ , rank sum test). Participants with the best MIS skills had the least smooth movements for all the limbs.

Figure 5-5 shows the frequency content of each limb in the first and second trials, for a typical subject. We see that the spectrum of the foot's movements increases from the first to the second trial. Over all subjects, the power spectral density of the foot movements, increases by  $42 \pm 20\%$  from the first to the second trial.

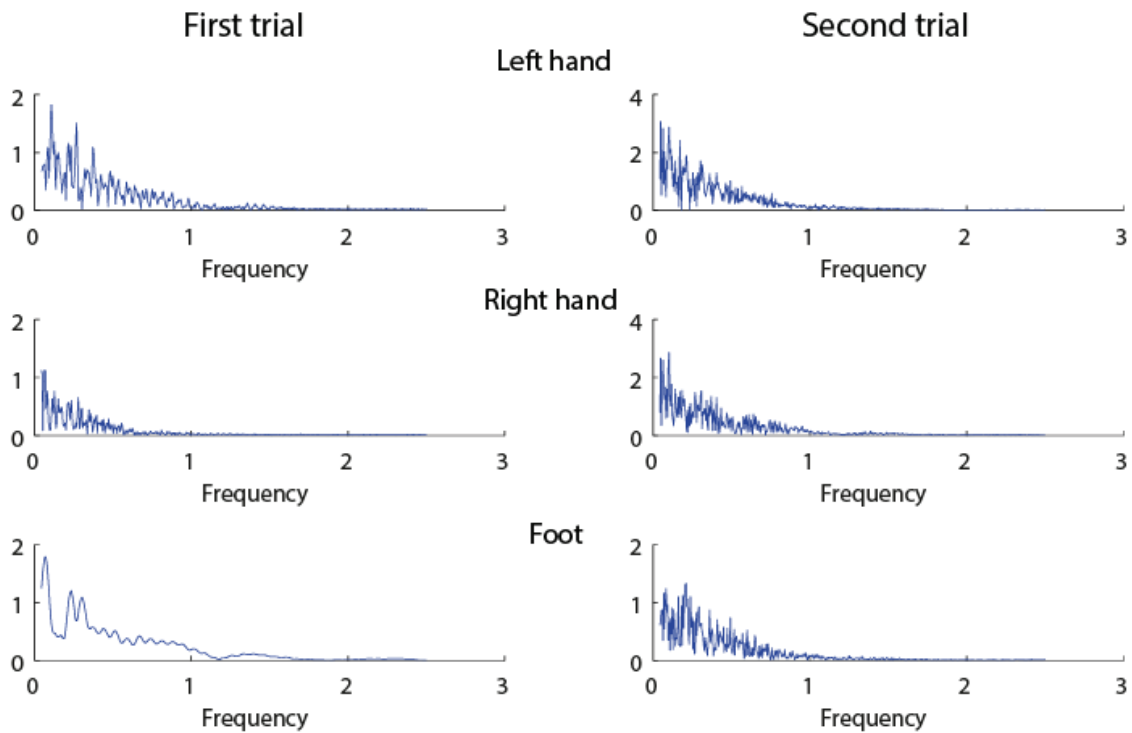


Figure 5-5 Spectrum of limbs' movements in the first and second trial for a typical subject.

### Foot Movement

The foot was moved an average of  $5.6 \pm 0.5$  times over all subjects in a two-minute trial. Students used their foot to move the camera  $7.6 \pm 1.1$  times whereas surgeons with more than 10 years of practice used their foot only  $3.5 \pm 0.7$  times ( $p < 0.04$ , rank sum test) (Figure 5-4).

Figure 5-6 presents the hands and the foot movements in the lateral plane for a sample participant, together with a histogram of these movements. The foot is visibly more frequently used in the second trial. The average number of times that the foot was used increased by 83% from the first to the second trial over all subjects. Calculating the mean and SD of sampled lateral foot positions, one can obtain the range of lateral motion centered at mean value with a length twice of the SD. This is the range that represents the foot position in 68.2% of time. The surface of the corresponding histograms in this range divided by its length provides the average number of times the foot's position is recorded in approximately the same location. Over all subjects, the number of times the foot is tracked in the same position decreases  $36 \pm 4\%$  from the first to the second trial which is a significant decrease ( $p < 0.03$ ,  $z = 4.6761$ , rank sum test). This indicates that the stationary periods of foot motion are less in the second trial.

Also, foot's lateral workspace increases by  $83 \pm 19\%$  ( $p < 0.04$ ,  $z = 4.1086$ , rank sum test) from the first to the second trial. This is obtained by calculating the lateral

workspace that covers 95% of the foot positions samples. 5% of the sampled positions situated at the two extremities of the workspace are neglected. Increase in lateral workspace represents the increase in tendency of using the foot for moving the camera in lateral direction. 47% of participants did not use their foot in the first trial, this decreased to 20% in the second trial. Although only lateral movements of the foot are effective for moving the camera, the movements in the sagittal plane are also recorded. It is observed that 13% of participants move their foot in the sagittal plane in harmony with their hands movements in the same plane.

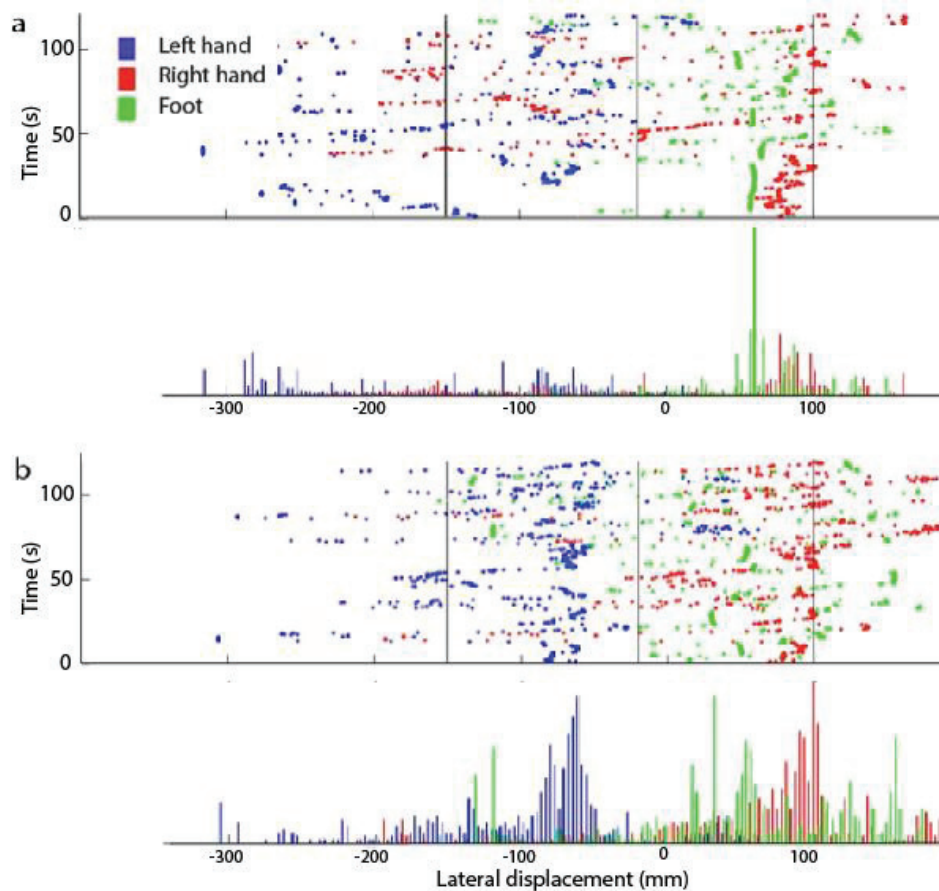


Figure 5-6 Limbs movements of a sample participant in visual feedback-only setup in (a) the first and (b) the second trials.

### Simultaneity of Limb Movements

Students aged between 21 to 30 years old moved their right and left hands simultaneously in  $40.6 \pm 3.9\%$  of the time. This is significantly higher than surgeons with more than 10 years of practice and aged more than 50 years old who moved their two hands simultaneously in only  $23.6 \pm 4\%$  of the time ( $p < 0.05$ , rank sum test). Residents with low to intermediate proficiency in minimally invasive surgery moved one of their hands and the foot simultaneously in  $12 \pm 3\%$  of the time whereas surgeons with more than 10 years of practice did it in  $4 \pm 1\%$  of the time ( $p < 0.02$ , rank

sum test). Also a similar difference is noted for the simultaneous movement of three limbs i.e.  $7.7\pm 1.8\%$  for residents versus  $3.2\pm 0.5\%$  for attending surgeons and  $2.2\pm 0.8\%$  for experienced surgeons, but it was not significant. There was no preference in choice of the hand that starts the movement at the beginning of the game.

#### **Subjective Assessment**

At the end of interaction with the setup, participants answered a set of questions about their experience. Statistical analysis showed no significant influence for any of the within-participants variables i.e. age, skill in MIS, status, age and proficiency in video games. The average questionnaire ratings are compared among the subgroups of each of the main factors. The significant differences are reported in this section.

The results of the questionnaire are illustrated in Figure 5-7. Surgeons aged between 31 to 40 years old were significantly less confused with the number of simultaneous tasks compared to those aged between 21 to 30 years old ( $p < 0.05$ , rank sum test) and those aged more than 50 years old ( $p < 0.04$ , rank sum test). In addition, they found it more natural to control three limbs independently, and reported less mental burden compared to other age groups. However, these differences were not significant. Participants aged between 41 to 50 years old were not taken into account as there are only two persons in this category.

Beginners found it more natural to control the two hands and the foot independently and they were less confused by the number of tasks they had to perform simultaneously than experienced subjects. But there is no significant difference between the participants with different levels of MIS skills. Gender and medical proficiency do not discriminate the participants' opinion about the task.

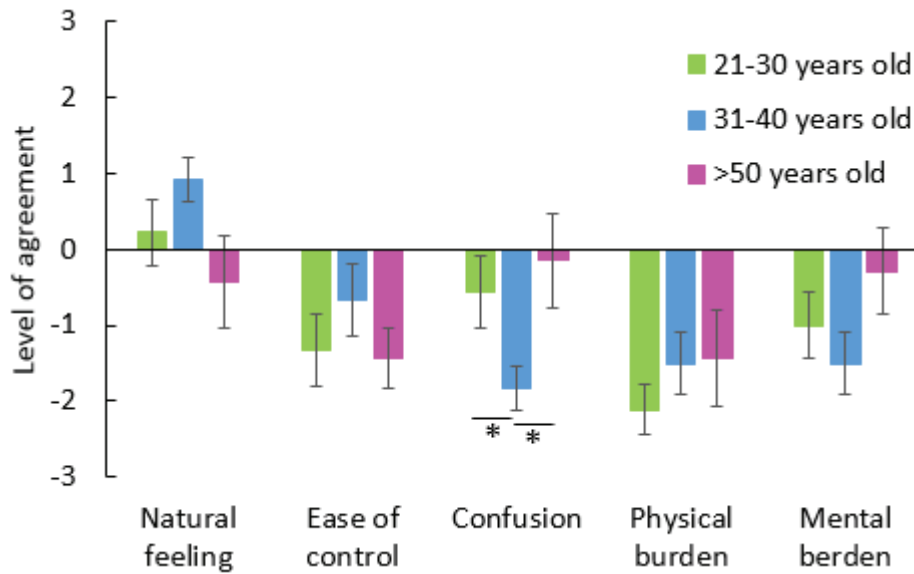


Figure 5-7 Average response of participants in different age categories to the questionnaire.

## 5.4 Discussion

An experimental study was conducted with thirty surgeons and medical students to investigate the possibility of controlling the endoscope by foot while performing a task with two hands. The setup provided visual feedback with unrestrained hands and foot movements recorded during the experiment. The number of caught objects, movement smoothness, the number of times that the foot is used and the proportion of time with simultaneous movement of the limbs have been compared between different groups of participants. Subjective assessment has been conducted through a questionnaire at the end of the experiment.

Residents caught the highest number of objects. The fact that half of the objects were caught by simultaneous touches from both hands instead of sequential touches in the four-second time window, shows a voluntary choice of simultaneous action of the hands. Surgeons with more than 10 years of experience – all of whom were also older than 50 – had the least smooth movements compared to others. While this may be due to tremor increasing with age [113], it is generally known that experienced surgeons have smoother and more stable movements while performing a laparoscopic task [114-116]. This study showed that their movements are less smooth compared to others while performing a new unfamiliar task i.e. performing a task with hands and controlling the camera by foot in the visual-feedback-only setup. The same group had the least simultaneous movements of the limbs, indicating a smaller tendency to coordinate movement between the limbs.

There was no priority in the choice of the hand that starts the movement at the beginning of the game. This is in agreement with the results of our previous study



that tested the possibility of reaching three objects with three virtual hands as fast as possible [107]. Interestingly, the foot had the same movement smoothness trend as the hands and comparing the movement smoothness of different groups returned the same results for all the three limbs. Although all participants were aware of catching all objects requirement, the number of times that the foot was used decreased constantly from students to experienced surgeons. This shows that experienced surgeons were less eager to move their foot. The large increase in the number of times that the foot is used from the first to the second trial indicates a steep learning curve resulting in performance improvement within a few minutes of practice.

The three measures of movement smoothness, caught objects and the number of foot usages are used to indicate the users' efficiency as well as their level of comfort in interaction with the paradigm. A *foot-hand coordination performance index* ( $\Pi_{fhc}$ ) is introduced to encompass these into a single quantitative measure of performance:

$$\Pi_{fhc} = \frac{\text{caught objects} \times \text{times foot used}}{|\eta_{sal}|} \quad (5.1)$$

The bigger is the  $\Pi_{fhc}$ , the more coordinated is the subject's behavior. The average  $\Pi_{fhc}$  for students, residents, attending surgeons and surgeons with more than 10 years of experience are 0.49, 0.62, 0.42 and 0.21 respectively.

Results of the performance index show that residents had the best performance compared to others. They could catch the largest number of objects and had the highest coordination metric. Attending and experienced surgeons were less successful in their interaction with the experimental setups. This shows that the best period for training medical professionals in controlling a robotic assistive arm is during their residency.

This hypothesis is corroborated by the answers to the questionnaire. Participants aged between 31 to 40 years old – 64% of whom are residents and the rest surgeons with less than 5 years of practice – have the most positive approach towards the control strategy. They found it more natural and easy to control three limbs simultaneously and independently. They were also least confused by the number of tasks they had to perform simultaneously and reported less mental burden. Residents are mentally flexible enough to accept new solutions and they have already gained some experience in the operating room with the endoscope to help them during the experiment.

It is trivial that the physical burden is age dependent. It is also the case in our experiment i.e. the more senior the subjects are, the more physically tired they get during the experiment. However, mental burden does not follow the same age dependent trend. Participants aged between 31 to 40 years old reported the least mental burden.



In general, the responses show that participants did not find it natural and easy to control the camera by foot and they reported a relatively high level of mental and physical burden. We think that this is due to the short period of participant's interaction with the setup. This hypothesis is backed up with our previous experiments with engineers, in which the possibility to control three virtual hands simultaneously and independently was proven [107, 117]. Two of the virtual hands were actually mimicking the movements of the two real hands and the third one was controlled by foot. We proved that with about 10 minutes of practice participants develop a more positive opinion about the control strategy and find it less tiring. The sense of ownership improved also with practice. This emphasizes the importance of practice in this approach. Also, to improve the embodiment of the endoscope as well as the general satisfaction of the control strategy, it is beneficial to have a set of trainings which start from a simple practice and get more complicated in successive stages, like our previous experimental setup.

Although the foot's role of moving the camera can be directly translated into moving the endoscope in laparoscopic surgery, the virtual environment and the task carried out by the two hands can be improved to simulate a surgical scenario. Also the effect of force feedback on the performance of the users may be investigated. This is addressed briefly in appendix A.

### 5.5 Conclusion

A robotic arm under the surgeon's own control will enable them to perform surgeries in the absence of assistants and will decrease the possible communication errors among the surgical team. We studied the possibility of controlling the camera by foot while performing a task with the hands. This scenario is close to moving the endoscope in laparoscopic surgery, one of the most common situations in which an assistant is needed while the task involves small movements and long periods of stable positioning of the instrument. In this research, the eventual end-users of the setup, i.e. surgeons, are involved in the early evaluation stage. Participation of surgeons and medical students provided useful information about their approach to the control strategy. Residents have the best performance. Surgeons aged between 31 to 40 years old reported the most positive subjective feedback on controlling the camera by foot. We conclude that the best time for training the surgeons to use their foot for controlling the camera is during their residency.



# 6

## Positioning the Endoscope by Foot: Influential Factors in a Virtual Trainer

### Summary

We have investigated how surgeons can use the foot to position a laparoscopic endoscope, a task that normally requires an extra assistant. Surgeons need to train in order to exploit the possibilities offered by this new technique and safely manipulate the endoscope in conjunction with the hands' movements. A realistic abdominal cavity has been developed as a training simulator to investigate this multi-arm manipulation. In this virtual environment, the surgeon's biological hands are modelled as laparoscopic graspers while the viewpoint is controlled by the dominant foot. Twenty-three surgeons and medical students performed single-handed and bimanual manipulation in this environment. The results show that residents had superior performance compared to both medical students and more experienced surgeons, suggesting that residency is an ideal period for this training. The virtual environment, similar to the surgeon's view from the abdominal cavity in laparoscopic surgery, was shown to improve the performance of experienced surgeons compared to a plain mono-coloured environment. This emphasizes the importance of using a familiar context for training such "three-handed surgery". Performing the task requiring collaboration of one hand and one foot improves the performance in the task engaging two hands and foot, whereas the converse was not true.

## 6.1 Introduction

In the previous chapters the three handed manipulation was studied using different setups and tasks. Mastering a “three instruments laparoscopy” with the two hands and a foot-controlled endoscope requires practice to acquire sufficient competency. Surgeons need training to acquire the necessary surgical skills before performing their first operation on patients. Simulators are routinely used for training various medical fields from dental procedures to orthopaedics and laparoscopy [85, 86]. It was shown that different types of endoscopy simulators including mechanical trainers, animal models and computer-based trainers, can improve trainee’s endoscopic skills [90], and that VR trainers have the potential to become an integral part of surgical education curriculum [91].

A virtual laparoscopic training program with progressive complexity can be used to train actual scenarios without endangering patient safety by repeating surgical tasks [92, 93]; it can record the training progress, assess trainees’ surgical skill objectively and offer informative feedback [94]. Previous works illustrated for example how such data could be used to show that performance metrics within endovascular simulations improve with training [95], or that 6 hours of training in virtual environment results in an improvement equivalent to 15 to 30 colonoscopies [96].

Introducing new technologies in the operational room demands new competencies for the surgeons besides surgical expertise [97]. Our vision is that VR simulators can be helpful to train the necessary skills for handling the foot controlled endoscope positioner in an intuitive manner. Previously, we have shown that the two biological hands and a third virtual hand (commanded by the foot) can collaborate in performing a task [107] and that using three hands was preferred to two hands in demanding tasks [118].

Here, we analyse the effect of a realistic virtual environment on the performance, as well as on the subjective assessment of the setup for acquiring skilful control of an endoscope positioner. In addition, two tasks with different levels of complexity are designed to study the possible transfer of learning between these tasks, which can help us determine in which order they could be trained. We also investigated subjective assessment of using the simulator for training using a questionnaire, and examined whether the results correspond to the objective assessment.

## 6.2 Methods

### Experiment

A population of twenty-three surgeons and medical students (eleven females) participated in the experiment, whose biographical data are presented in Figure 6-1. Subjects were discriminated according to their age, professional status (i.e. student in medicine, resident acquiring proficiency in a specialty, surgeon attending the operational room after the training period or surgeon with more than ten years of experience) and self-assessed proficiency in minimally invasive surgery. Their proficiency in video games was assessed by reporting the frequency of playing video games, between “never”, “once a week” and “more”. Participants’ specialty was not taken into account as all of them except four were generalists, two were urologists and two had no specialization. In Chapter 5, it was shown that speciality does not have a significant influence on the participants’ performance. The experiment was approved by the BMI Ethics Committee for Human Behavioural Research at EPFL. Informed consent was obtained from all subjects.

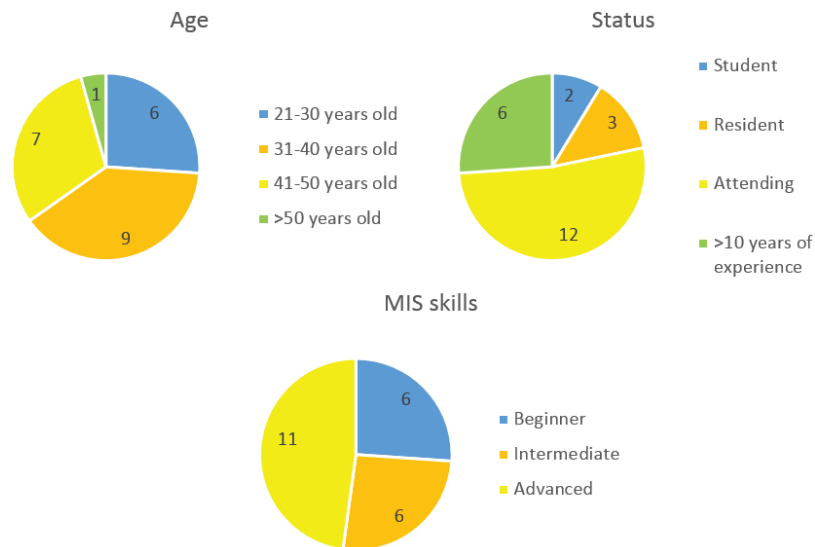


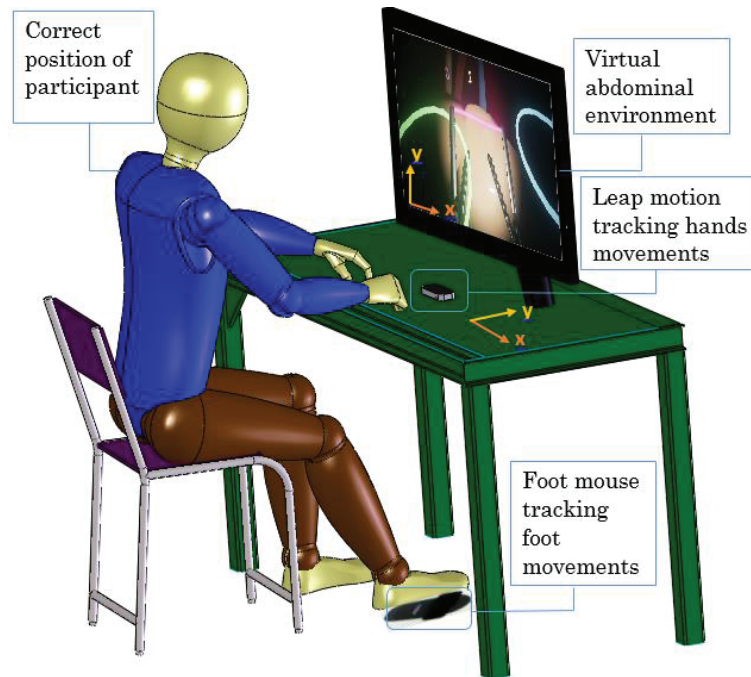
Figure 6-1 Statistical information of the subjects' population.

### Setup

Figure 6-2 shows the setup used for the experiment. The hand movements are tracked in 3D space using a dedicated camera<sup>1</sup> named Leap Motion Controller. The camera is placed on the table, in front of the screen looking upwards. A stable tracking is provided when the hands are placed about 20cm above the camera. At this height, the workspace will be a rectangle with a length of 23cm along the screen and 14cm perpendicular to it with the camera placed at the centre of the rectangle

<sup>1</sup> [www.leapmotion.com](http://www.leapmotion.com)

[119]. The planar movements of the foot are tracked using the BiLiPro foot mouse<sup>2</sup>. The foot is fixed inside the foot mouse's paddle placed on the ground.



**Figure 6-2 Setup to investigate simultaneous hands and foot movement in a virtual abdominal environment.**

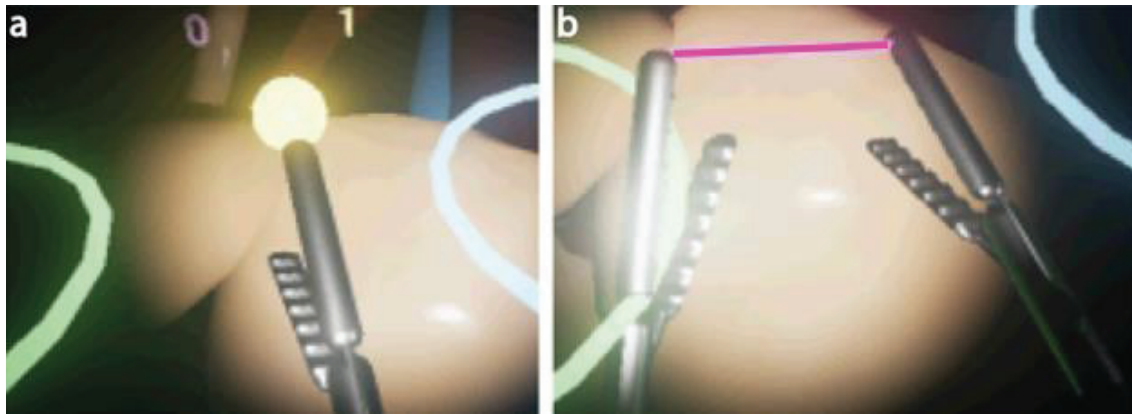
## Paradigm

The experiment was conducted in a virtual environment consisting of the abdominal cavity and two graspers manipulated by hands. This environment was developed in order to investigate the possibility of controlling the endoscope by foot while moving an object with one or both hands. Each user's hand is modelled as a laparoscopic surgical grasper. Participants see only part of the virtual space and can move the virtual camera using their foot to view the hidden parts. A circular beam of light indicates where the camera is pointing at. Participants performed two different tasks, both requiring to move an object from the "initial region" (represented by a circle on the left) to the "target region" (represented by a circle on the right).

Figure 6-3 shows a screen shot of each of the two tasks. The first task is to study the possibility of coordination of one hand and one foot. A ball has to be i) caught with one grasper, ii) moved from the initial circle to the target circle, iii) and then released (Figure 6-3a). The catch and release are automatic i.e. the ball is caught once a grasper is inside the initial circle and it is released once the grasper reaches the target circle.

<sup>2</sup> [www.bilipro.com](http://www.bilipro.com)

The task starts within the initial circle while the target circle is not visible on the screen. The camera should be moved from left to right in order to bring the target circle into the sight. Participants are instructed to keep the ball inside the light circle by moving the hand and foot synchronously. The same task is performed half of the trials with each hand. The other task is to study the collaboration of the two hands and foot as well as the bimanual coordination. It is similar to the previous task but with both hands engaged in catching the two ends of a bar (Figure 6-3b), and then bringing it from the initial to the target circle. Each of the single handed and bimanual tasks lasts four minutes.



**Figure 6-3 Two tasks in virtual abdomen environment: Move a) a ball by a grasper and b) a bar by two graspers, from the initial circle to the target circle.**

### Assessment

Objective and subjective results are presented for the single handed and bimanual tasks. The position of the hands and foot are recorded at a frequency of 5Hz. The slow movements are fit with a cubic B-spline, from which the velocity is computed. Subjects' performance is assessed by the number of successfully transferred objects from the initial to the target regions. Movement smoothness of the two hands represented as graspers as well as of the foot which controls the camera position, is computed from the spectral metrics [120]. Smoothness is a quality related to continuity or non-intermittency of a movement, independent of its amplitude and duration.

Participants are instructed to keep the graspers inside the light circle corresponding to the camera focus area. Foot-hand coordination is evaluated on the basis of time percentage where the grasper is inside the light circle (camera focus) with respect to the total time during which the grasper is moving. The movement harmony between the hands in the bimanual task is computed from the cross correlation between the two hands movement. The hands are moving in harmony characterised by a correlation close to +1, when they move in the same phase i.e. both to the right or

left at the same time. Their movements do not harmonise when there is 0 correlation and anti-correlation indicated by  $-1$ .

At the end of each of the two tasks, participants answer the same questionnaire of Table 6.1. Each statement should be ranked in an ordered response Likert scale from  $-3$  (strong disagreement) to  $+3$  (strong agreement). Half of the subjects start with the unimanual task and the other half with the bimanual task, in order to investigate the effect of practicing one task on the other task's performance. Results obtained from the questionnaires provide a subjective measure of performance.

**Table 6.1 Questionnaire filled after each task.**

<b>Questionnaire statements</b>	
<b>Q1</b>	It felt natural for me to move the hands and the foot independently.
<b>Q2</b>	It was easy for me to control the camera by foot.
<b>Q3</b>	It was easy for me to make the mental translation between my hand and the grasper.
<b>Q4</b>	I felt as if my real hands were turning into 'virtual'.
<b>Q5</b>	I got confused with the number of tasks that I had to perform simultaneously.
<b>Q6</b>	The abdominal virtual environment helped me to think of the task as a surgical procedure.
<b>Q7</b>	It was physically tiring for me.
<b>Q8</b>	It was mentally tiring for me.

### Statistical Analysis

The measures of performance were averaged across trials for each participant. Results were analysed using multivariate analysis of variance (MANOVA) with three within-participants factors: age, skill in MIS surgery and status. Significant results were further analysed using a pairwise comparison. The data sets were checked for normality using the Kolmogorov-Smirnov test [112]. Non-normal data sets were compared for possible significant difference using the rank sum test, and the 2-tailed, paired-sample  $t$ -test was used for normal data sets. A 5% significance level was used in these tests. The standard error of the mean (SEM) values are reported through the text and in the plots. The same statistical procedure was carried out for questionnaire ratings.

## 6.3 Results

No gender related performance difference was detected thus this factor was not considered for further analysis. Results are presented for the whole population regardless of the sequence of performing the two games. Analysis of MANOVA



indicated that age is the most influential discriminator of the global results. The following is a detailed statistical analysis of the effect of different parameters on measures of performance.

### **Successful Attempts**

In the single-handed task, an average of  $5.8 \pm 0.5$  balls per minute and in the more complex bimanual task  $2.7 \pm 0.4$  bars per minute were successfully transferred from the initial to the target circle. Participants with intermediate proficiency in laparoscopic surgery, were more successful in transferring the objects from the initial to the target circle in both single handed ( $6.6 \pm 1.4$ ) and bimanual ( $3.6 \pm 0.7$ ) tasks. In the bimanual task, this was significant in comparison with the beginners with  $1.7 \pm 0.3$  transferred objects (t-test,  $p < 0.04$ ,  $t = -2.8259$ ). Residents transferred more objects compared to others in both single handed and bimanual tasks. Age dependency was low with no significant difference among the age groups.

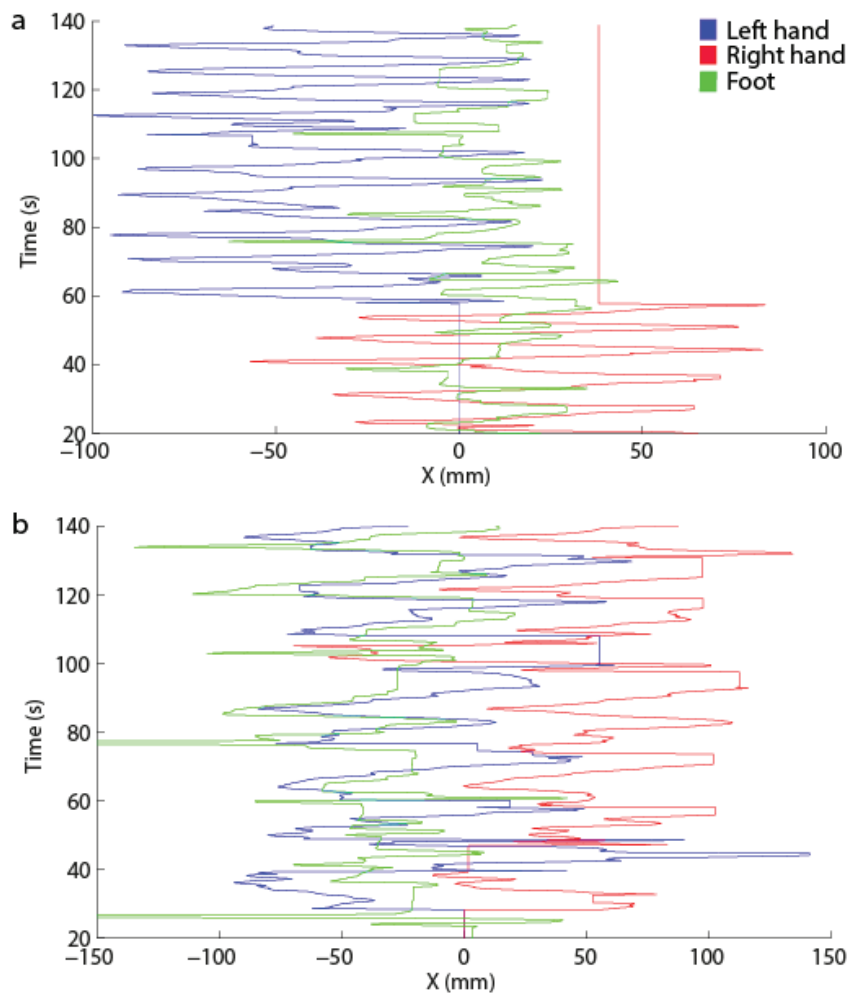
### **Movement Smoothness**

In single handed task, participants aged between 21 to 30 years old who are beginner in MIS skills had the smoothest movements of all age classes. It was significant for the foot in comparison with those aged between 31 to 40 years old (rank sum test,  $p < 0.05$ ).

In the bimanual task, those aged between 31 to 40 years old had the smoothest movements for all limbs. Similarly, subjects with intermediate MIS skills had smoothest movements, with a significant difference for the left hand in comparison with beginners (t-test,  $p < 0.01$ ,  $t = 4.1505$ ). Beginners in MIS skills had the least smooth movements for all the limbs, whereas they had the smoothest movements in the single handed task. Residents had the smoothest movements for all the limbs in both single-handed and bimanual tasks. While experienced surgeons had the least smooth movements in single-handed task, all their limbs' movements were much smoother than students in bimanual task.

### **Foot-Hand Coordination**

Figure 6-4 presents the hands and foot movements of a typical participant in the single-handed and bimanual tasks. During the single-handed task, in average over all participants, the active hand is kept inside the light circle  $58 \pm 2\%$  of the time. Different groups of participants exhibit roughly the same results. During the bimanual task, in average over all participants, both hands are inside the light circle in  $20 \pm 6\%$  of the total time while the left and right hands are in focus  $49 \pm 3\%$  and  $53 \pm 6\%$  of the time, respectively. Beginners aged between 21 and 30 years old are the most successful ones in keeping the graspers in the camera view.



**Figure 6-4** Hands and foot lateral displacement in a) single handed and b) bimanual tasks.

### Hand Coordination in the Two-Handed Task

Comparing the position of hands in the bimanual task using the cross correlation returns an average of  $0.73 \pm 0.19$ , exhibiting good movement coordination between the hands. Different groups of participants exhibit similar results.

### Subjective Assessment

In the single-handed task, surgeons with more than 10 years of practice found it easier to control the camera by foot than attending surgeons (Q2, rank sum test,  $p < 0.04$ ). Beginners aged between 21 to 30 years found the abdominal like virtual environment more helpful compared to other age groups. The difference was significant compared to intermediately skilled surgeons (Q6, rank sum test,  $p < 0.02$ ) (Figure 6-5a). No significant difference was detected among different age groups.

In the bimanual task, beginners aged between 21 and 30 years found the abdominal like virtual environment more helpful compared to others age classes, in particular

relative to those aged between 31 and 40 years old (Q6, rank sum test,  $p < 0.03$ ) (Figure 6-5b). Other comparisons return the same results as those of single handed task although the differences are not significant.

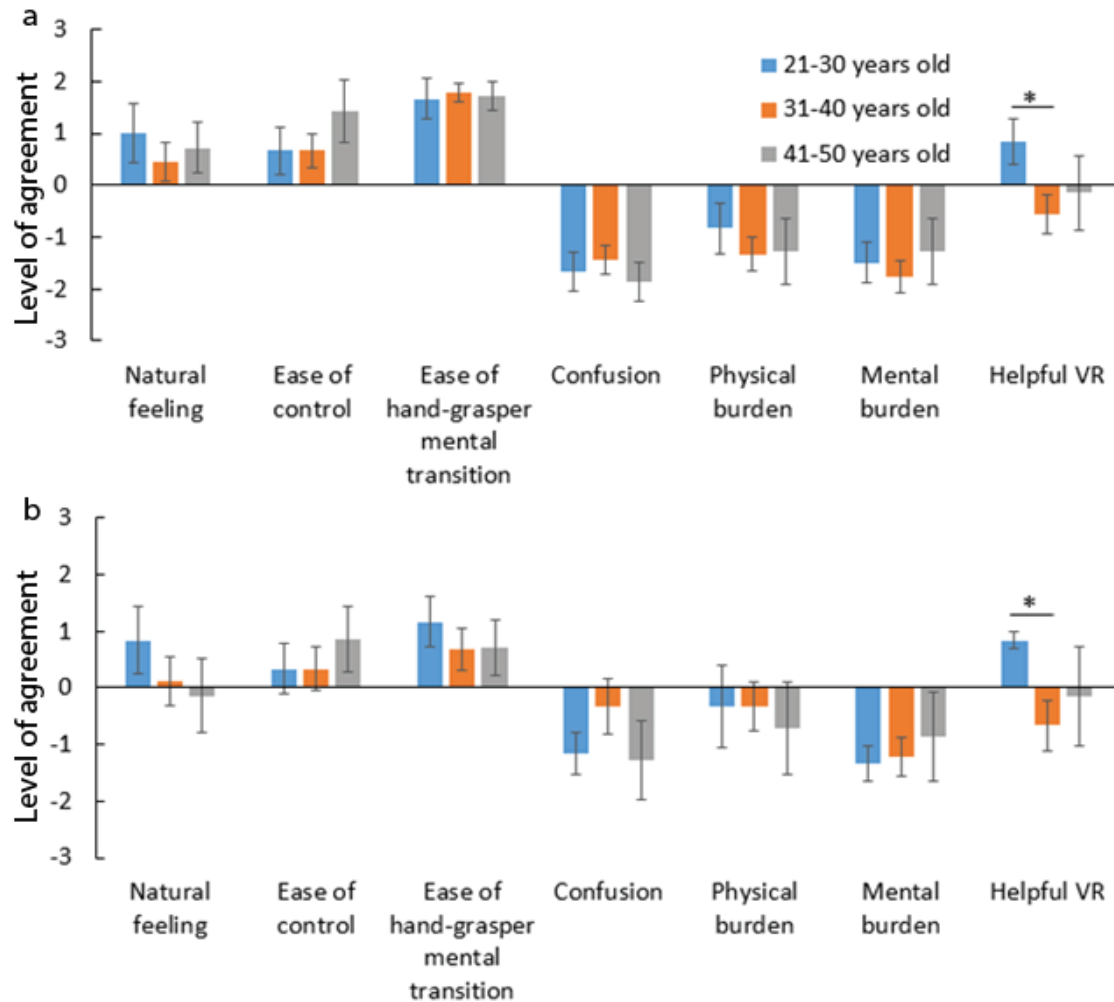


Figure 6-5 Subjective assessment of the a) single-handed and b) bimanual experiment.

## 6.4 Discussion

An experiment was conducted with twenty-three surgeons, residents and medical students in a virtual environment similar to the view provided in laparoscopic abdominal surgery. The virtual camera could be moved by the user's foot to view different parts of the abdominal cavity. The task required to keep the camera's focus on an object moved with one hand or two hands from an initial to a target region. The goal was to study the hands and foot coordination through objective and subjective measures.

Beginners in MIS skills, the oldest of whom was thirty-three years old, had the smoothest movements in the single handed task and the least smooth movements in the bimanual task. This indicates that while younger participants are better in moving one hand and the foot, more experience in MIS helps in moving two hands and the foot.

Subjects with bimanual movement harmony above global average, had a higher than average performance in 68% of the cases. Those who started with the single handed experiment, had more harmony in their limbs movements in the bimanual task. In addition, they had smoother movements for all the limbs and more simultaneous movement of the hands. On the other hand, participants who started the experiment with the bimanual task exhibited similar performance as the other group in the single handed task. This highlights the importance of carrying out training in a progressive sequence of tasks. Moving from a single task to a more complex one improves the proficiency of the users, whereas, the opposite sequence does not improve the users' skill. This is backed by simple-to-complex sequence of instructions theories [121].

Successful participants are defined as those who correctly moved more objects than the global average. In both experiments, this group emphasized on the positive influence of the realistic virtual environment on their performance. They also were less confused by the number of the tasks they had to perform simultaneously. However, interestingly the unsuccessful group found it more natural to move the limbs independently and reported less physical burden. We conclude that the level of confusion provides the most accurate prediction of the participants' performance.

We have previously performed a set of experiments with surgeons, who had to move the virtual camera by foot in a plain white environment and catch falling cubes by hands. In the current experiment with a realistic environment, the performance metrics improved and participants found it more natural and easy to control the camera by foot compared to our previous set of experiments. We think this is due to the realistic virtual environment in the new experiment. In both experiments residents were the most successful group in scoring, had smoother movements and improved coordination between the hands. While experienced surgeons had the least smooth movements in our previous study, in the current experiment they had smoother movements compared to students in the bimanual task. This indicates the influence of a familiar VR on the users' performance. Experienced surgeons are more used to the view they have in laparoscopic surgery, thus their performance improves once they are exposed to a similar VR compared to an irrelevant environment.

## 6.5 Conclusion

The concept of replacing human endoscope holders with mechanical arms has been addressed during the past two decades. The idea is for the surgeons to be capable of controlling this third arm by themselves. Like any other competence, surgeons need training for mastering this skill. No study on the best training virtual environment, tasks and training time had been conducted so far. We studied surgeons' and medical students' approach towards controlling the endoscope in laparoscopic surgery through an experimental study in a virtual environment which resembles the abdominal cavity. Residents have the best performance compared to medical students and more experienced surgeons. The sequence of the tasks designed for training is important. Performing a task which involves one hand and foot collaboration has a positive influence on performing a task which engages two hands and foot, whereas the opposite is not true. A virtual environment, similar to surgeon's view from the abdominal cavity in laparoscopic surgery, improves the experienced surgeons' performance compared to a plain mono-coloured environment.

We confirm our previous finding about the residency to be the best time for training to use the third arm. In addition, our results emphasize the influence of a familiar and context related environment on the users' performance.



# 7

## Experiments on a Third Robotic Arm Manipulation Using Two Novel Foot Interfaces

### Summary

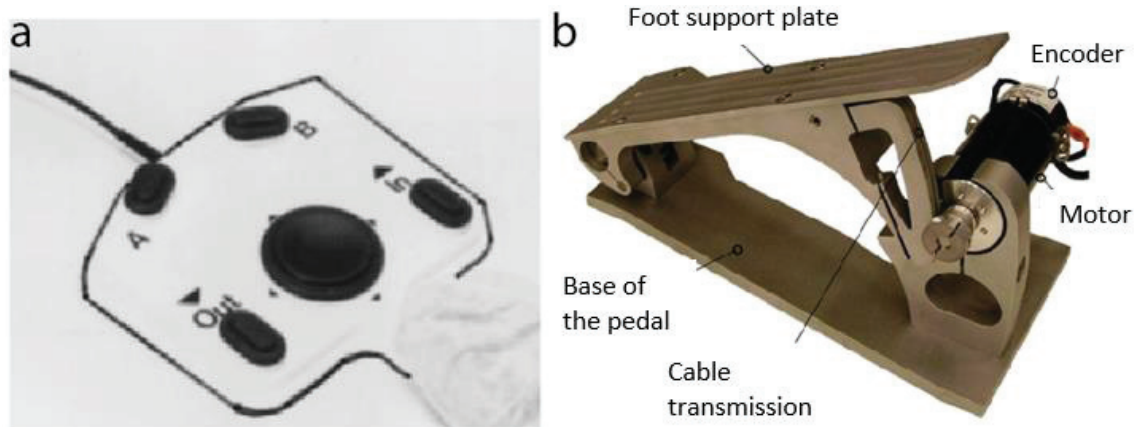
Currently available foot interfaces to command an external robotic arm for surgery typically consist of a couple of push buttons placed on a planar platform. In this chapter, we propose and compare two robotic foot interfaces implementing isotonic vs. elastic–isometric control strategies. The modified Delta Thales robot with four degrees of freedom is used as the slave robot to test these interfaces and control strategies. It is controlled by foot’s translation/rotation in the isotonic interface and by force/torque in the isometric interface. The isotonic interface is used for position control, and the isometric interface for rate control.

An experimental study mimicking a laparoscopic surgery task is conducted to compare the performance with these two systems, in which the slave robot is used as an endoscope holder controlled by the foot in the specific interface. The subjects prefer using the isometric interface which they find more intuitive and less tiring. The low physical burden of this interface allows the users to concentrate on the task. Also, they prefer the rate control as it provides them with a more accurate control on the slave robot. This is the first study comparing these two control strategies for controlling a supernumerary robotic arm.

## 7.1 Introduction

Experiments in virtual environment, presented in Chapters 3 to 6, show that the foot can be used to command a supernumerary limb in certain manipulative tasks. Currently available foot interfaces developed for controlling endoscope positioners generally consist of a couple of push buttons placed on a planar platform with no feedback on the device. For instance such type of interface equip the RoboLens system, using six buttons on a planar surface [38], the EndoAssist has a foot pedal to trigger on/off of the head movement tracker [122], ViKy system has seven buttons [36] and AESOP uses eight buttons on a planar surface [46] (Figure 7-1a).

Apart from endoscope positioners, foot pedals are widely used for vitrectomy in microsurgery [123], dentistry, sonography [124], surgery, etc. to activate/deactivate tools. Another approach is presented in [125] where a one DoF foot pedal is used to activate a surgical instrument. The instrument's speed is proportional to the pedal's position. Force feedback applied on the foot provides additional information on the instruments interaction with environment (Figure 7-1b).



**Figure 7-1 a) AESOP foot interface [46], b) One DoF foot pedal with force feedback [125].**

More sophisticated interfaces have been developed for ankle rehabilitation e.g. PKankle with three actuated rotational degrees of freedom [126] and an ankle-foot orthosis with two degrees of freedom [127] (Figure 7-2). These interfaces need to be worn on the foot and constrain the leg's translational movements. A wearable foot interface (FI) has also been developed for controlling a prosthetic arm [128]. Successful control of the grasp was demonstrated, basically consisting in on/off steps activated by a specific combination of pressure switches. The interface has four switches and consequently can potentially control two DoFs without combining the switches.



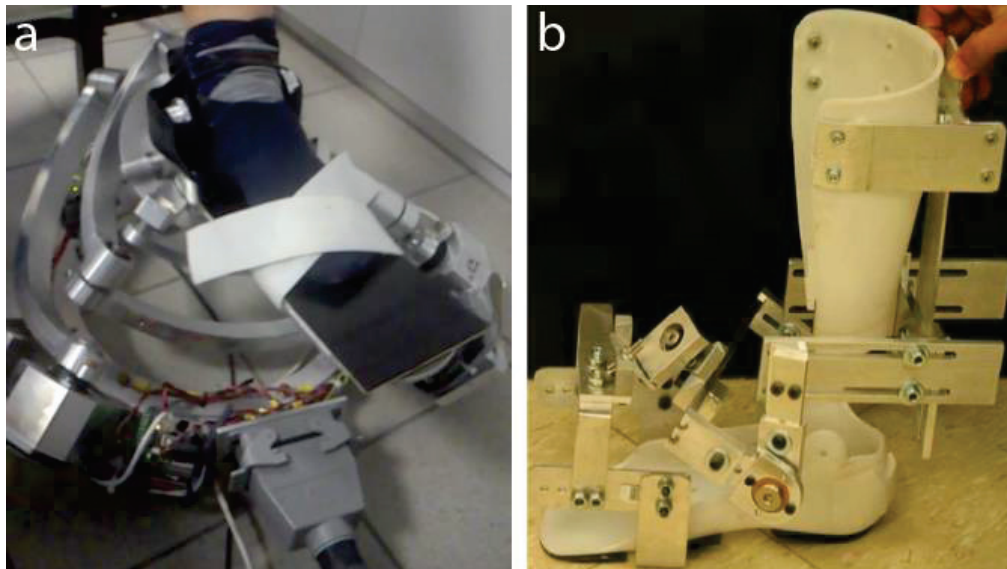


Figure 7-2 Ankle Orthoses with a) three [126] and b) two [127] DoFs.

In the previous chapters of this dissertation, only planar movements of the foot were used to control the virtual hand or laparoscope. However, the two translational DoFs of the foot are hardly enough for controlling a robotic arm moving in the multi-DoF space. A potential application of a multi-DoF foot controlled robotic arm is surgical interventions. In laparoscopic surgery for instance, each instrument has at least four DoFs: yaw, pitch, roll and insertion through the trocar (Figure 7-3). Some instruments like the grasper may have additional DoFs e.g. rotation of the grasper's jaws. If the inserted instrument is an endoscope, its insertion and withdrawal results in zooming in and out of the captured scene. The roll would rotate the scene on the screen while pitch and yaw are used to move the scene and bring hidden areas into the camera's view.

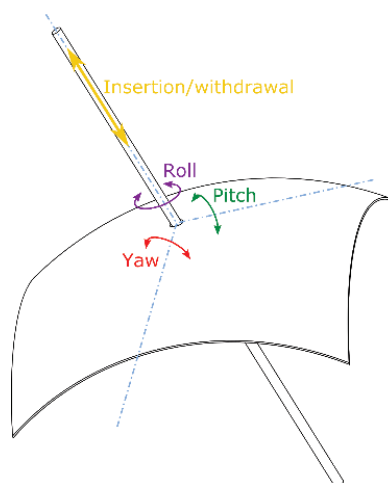


Figure 7-3 Four DoFs of a laparoscopic surgical instrument inserted in the abdominal cavity through a trocar.

To the best of our knowledge, no FI has been developed with four DoFs control capacity with a design other than a number of switches placed on a board. In order to avoid distraction and/or interruption, the control paradigm should feel natural and intuitive to the operator, as if the supernumerary hand is like one's own hand. Intuitiveness of control should be kept in mind in the design of the platform. This chapter investigates the possibility of controlling four DoFs of a robotic endoscope holder by one foot using two different dedicated FIs while performing a task with hands. Holding an endoscope in laparoscopic surgery is chosen as the baseline due to its simplicity compared to other surgical tasks.

## 7.2 Two Foot Interfaces, Two Control Strategies

Two foot interfaces are developed to study two different control strategies. Isometric devices also known as pressure or force devices convey commands received through force or torque. On the other hand, isotonic devices also known as displacement devices control the end effector through translational or rotational displacements [129]. Both of the developed interfaces have four DoFs and are designed to provide an intuitive control platform. To assure full control of the slave robot with no redundancy or unpredictable movements, a one to one relation between the DoFs of the master FI and the slave robot is used. The master interface should be secured against tremors and provide comfortable rest positions for long term usage.

### 7.2.1 Foot Characteristics

Design of an ergonomic interface requires understanding of the foot characteristics. Without the toes, the foot has 6 DoFs including three rotational and three translational DoFs. Its rotational DoFs are presented in Figure 7-4.

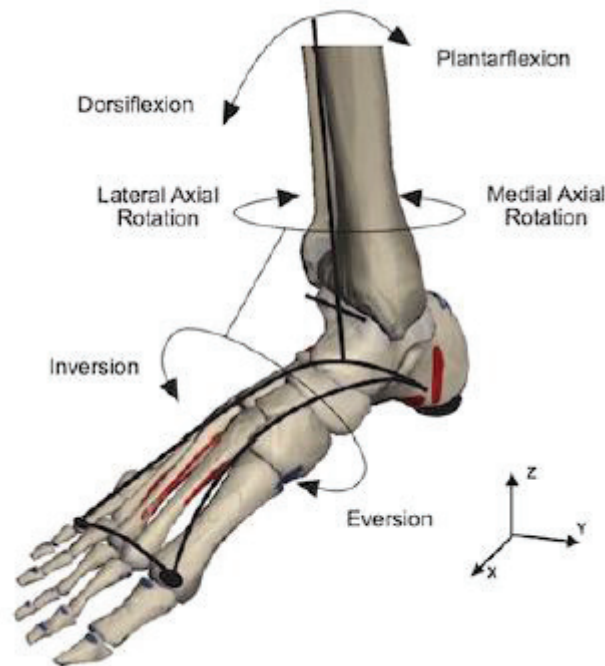


Figure 7-4 Rotational DoF of foot (<http://skimoves.me/tag/ski-boots/>).

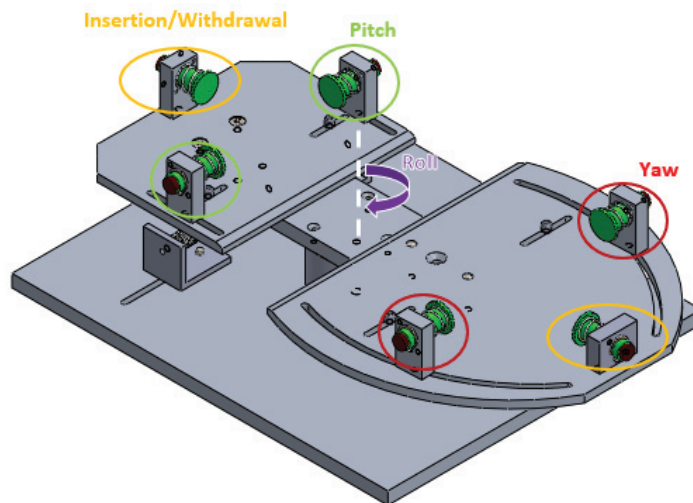
The foot's maximum force and torque are measured for three seated men with a mean age of 24 years old. The measured force and torque are considered as maximal when it becomes difficult to maintain the strength for more than 20s. The results presented in Table 7.1 provide a rough estimation of human's foot capacity for tuning of the mechanical design. The interface should be operational with forces and torques well below the reported threshold to guarantee its functionality for users with various physical conditions.

Table 7.1 Foot characteristics: Average maximum force and torque exerted by three healthy males with a mean age of 24 years old.

	+z (N)	-z (N)
Maximum vertical force	90	180
	Lateral axial rotation (N)	Medial axial rotation (N)
Maximum force on the toes with the heel as pivot	50	70
Maximum force on the heel with the front of the foot as pivot	30	50
Maximum torque in medial/lateral axial rotation (Nm)	10	

### 7.2.2 Elastic–Isometric Foot Interface

The first developed interface is a four DoFs elastic–isometric device. The commands are generated by pressing against small pistons placed around the foot. The interface is portable with a weight of 2.4Kg and a volume of 335 (average of minimum and maximum length)  $\times$  250 (width)  $\times$  65 (height) mm<sup>3</sup>. Figure 7-5 presents the positions of the sensors and the matching of DoFs from master (input) device to tool. The positions of the sensors are chosen to maximize the intuitiveness of the control by matching the foot movements with the corresponding robotic arm movements. The sensors work in pairs: two facing pistons for the positive and negative directions of each DoF. The interface includes six pistons which provide three DoFs: i) front and back pistons engage translation of the foot in x direction, ii) forefoot sides' pistons engage combined planar flexion and lateral/medial axial rotation of the foot and iii) back foot sides' pistons engage combined dorsiflexion and lateral/medial axial rotation on the foot. The fourth DoF is provided by foot rotation around the vertical axis.



**Figure 7-5 Elastic–isometric FI: Sensor positions and the corresponding manipulated DoFs of a laparoscopic tool.**

Figure 7-6 represents the sensor block. Each block consists of a piston, a piston support, a sensor support and a screw for fixing the block on the plate. An analog Hall effect sensor, a magnet and a spring make the elastic–isometric control possible. The spring is compressed by a small amount detected by the Hall probe. Its output voltage controls the movement of the slave robot. There is no initial contact between the foot and the pistons. This is a mechanical safety measure to reduce the possibility of involuntary commands. The user has to actively decide to move the foot and press against a piston for moving the robotic arm. The positions of the sensor blocks as well as the global size of the interface are adjustable to match most foot sizes.

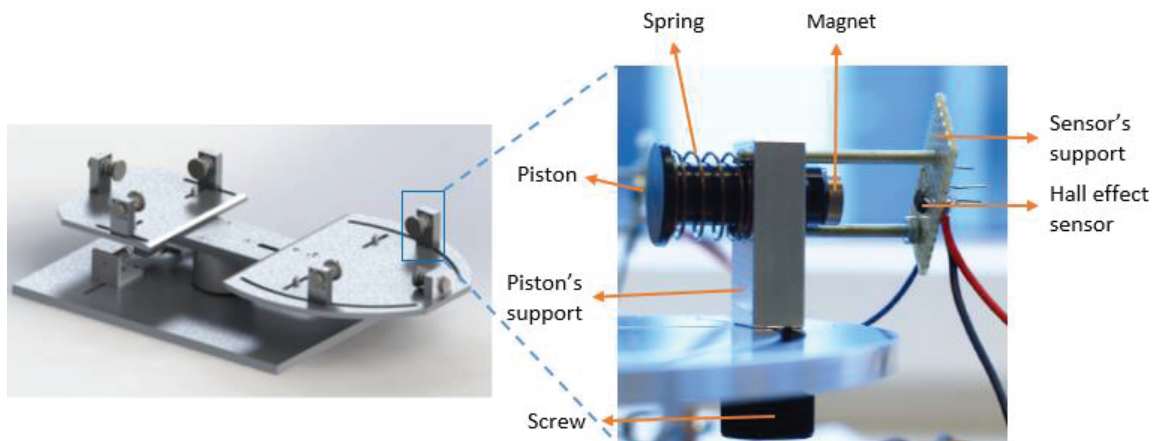


Figure 7-6 Sensor block of the elastic-isometric FI.

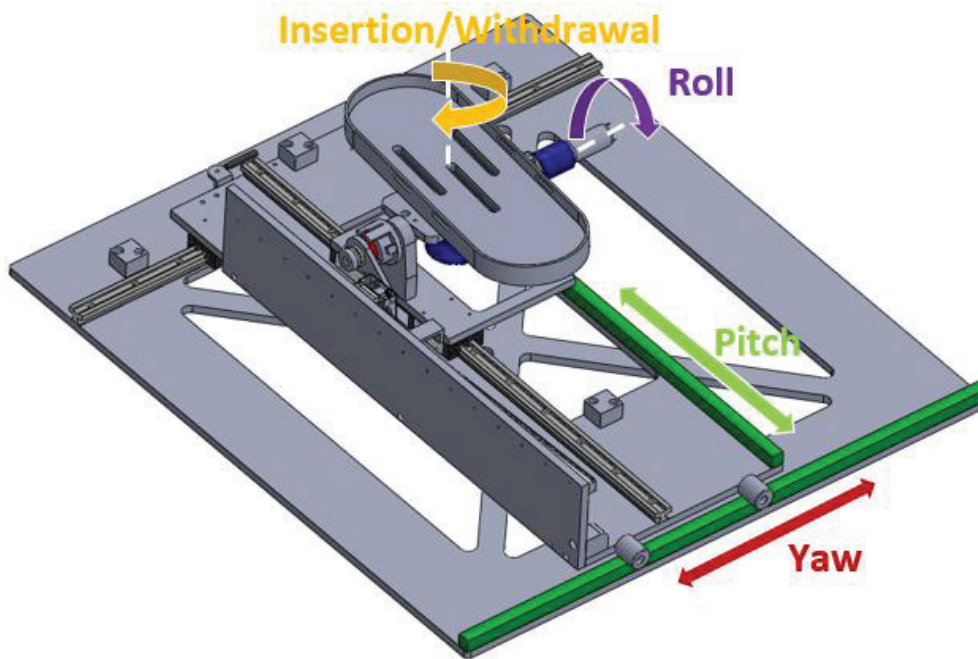
### 7.2.3 Isotonic Foot Interface

In addition to the elastic-isometric interface, a four DoFs isotonic foot interface has been developed as well. In this interface the commands are generated by the foot's either translational or rotational movements. The interface has a volume of 765 (length)  $\times$  690 (width)  $\times$  190 (height) mm<sup>3</sup>.

The developed interface is shown in Figure 7-7. The four DoFs are named according to the manipulated DoFs of a laparoscopic tool. Two translational and two rotational DoFs are used for commanding the slave robot. The translational DoFs are generated by i) flexion/extension of the knee joint for insertion/withdrawal of the instrument and ii) abduction/adduction of the hip for yaw of the instrument. The rotational DoFs are generated by i) dorsiflexion/plantarflexion of the foot for pitch of the instrument and ii) lateral/medial axial rotation of the foot for roll of the instrument.

The controller provides the flexibility of mapping the DoFs of the endoscope positioner on the FI in any other possible combination as well. The suggested mapping in Figure 7-7 has the advantage that the more important DoFs (pitch and yaw) are mapped on the DoFs of the FI with larger range compared to the other two DoFs. The yaw and pitch provide the possibility of bringing different areas of the workspace into camera's view. The two rotational DoFs of the isotonic interface have smaller ranges due to humans' physical limitations in the ankle joint. These DoFs are associated to insertion/withdrawal and roll. Insertion and withdrawal are used to zoom in and out the camera's view on the screen, whereas the roll adjusts the angle of view. Consequently, compared to pitch and yaw, these DOF are less important in having the right area in the camera's sight.

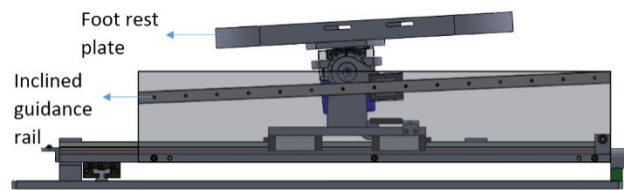




**Figure 7-7 Isotonic FI: Two translational and two rotational DoFs and the corresponding manipulated DoFs of a laparoscopic tool.**

The foot's translational movements are tracked using magnetic membrane potentiometers with a repeatability of 1mm. This provides contactless tracking of the movements with no additional induced friction in the system. The resolution at optimal wiper tracking depends on the resistance layer's homogeneity. It is indicated as infinite at optimal wiper tracking. The device's range of motion is 18cm for the movement corresponding to pitch and 26cm for the movement corresponding to yaw. Rotational movements are tracked by encoders. The device's range of rotation is 40° for the insertion/withdrawal DoF and 60° for the roll DoF. Rotational movements are tracked using encoders. Dorsiflexion/plantarflexion as well as lateral/medial rotations are measured by incremental encoders. These rotational movements are motorized providing the possibility of having force feedback for these DoFs.

The foot rests on a plate during the idle phase. The comfortable rest position may vary on the basis of the position of the interface with respect to the user as well as the user's anatomy. A comfortable rest position is assured by the mechanical design of the interface as well as the controller's design. On one hand, the rest plate's inclination changes passively according to its position along the insertion/withdrawal axis. The plate is connected to an inclined linear guide with a 2.5° angle to follow the natural inclination of the foot in the sagittal plane (Figure 7-8). On the other hand, the controller is designed to provide an adjustable rest position, defined as the initial position of the foot on the plate after running the controller.



**Figure 7-8** Inclined guidance rail and the foot's rest plate. The plate's angle in the sagittal plane changes by the rail's inclination to follow the user's natural posture.

### 7.2.4 Thales: The Slave Robot

Both foot interfaces can control a robot with four DoFs. The robot used for our experiments is the Delta Thales robot which provides a translational DoF (insertion) and three rotational DoFs [130, 131]. This robot provides the necessary Remote Center of Motion (RCM) for an instrument holder in laparoscopic surgery. The RCM should be co-localized with the trocar on the abdominal wall. The small size of the trocar results in limited choices for the mechanical design of the instrument holders. The parallel light weight kinematics of the Thales makes it a good candidate for our application. The robot is based on two geometrically linked delta structures [132].

Originally the robot was designed to have three DoFs: insertion and two rotational DoFs which are yaw and conical rotation of the instrument around the vertical axis. A few modifications were made on the robot to add the fourth roll DoF for meeting the requirements of a laparoscopic instrument holder. The original end effector rod was replaced by two concentric tubes with the outer tube as a position reference. The inner tube was actuated to provide the roll. The actuator was added on the end effector in series with the other DoFs. A few other modifications were made to obtain an appropriate workspace and an RCM position. Figure 7-9 represents the modified robot with four DoFs.

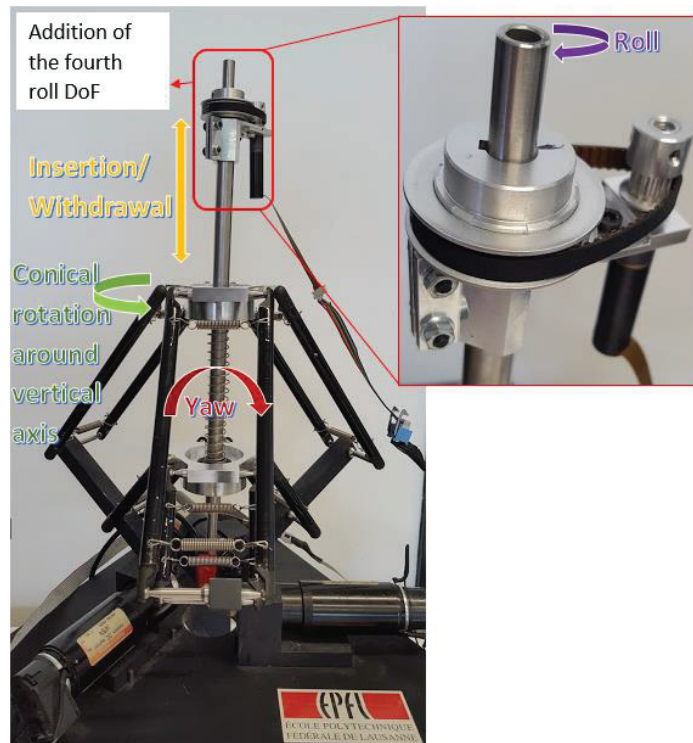


Figure 7-9 The modified Thales robot with the added fourth DoF.

### 7.2.5 Master-Slave Communication

The presented master FIs should be able to communicate with the slave robot to transmit and receive data from one another. Figure 7-10 presents the whole master-slave communication system. The inputs of the FI slave device are read by an STM32 microcontroller. The data are then sent to the input (master device)-output (slave robot) communication platform through a universal asynchronous receiver transmitter (UART) to USB connection. A graphical user interface (GUI) represents this platform.

The mapping of the master interface's DoFs on the slave robot can be adjusted in the GUI. Any DoF of the master interface may be mapped on any DoF of the slave. The robot starts moving only after a defined number of steps are received from the master device. An appropriate filter ensures the security of the interface against tremors. This is especially important for the isotonic FI. The translational movements of the platform may result in involuntary rotational movements. To avoid unwanted commands to be sent to the slave robot, a relatively high number of steps should be received from rotational DoFs of the isotonic FI before the robot starts moving.

Before starting to command the slave robot, the user is asked to activate every DoF on the master platform. The comfortable range of motion of the user is registered and used as the reference range of motion. In isotonic FI, the slave robot's workspace



is mapped on the reference range so that the whole workspace can be spanned by moving the foot in this range (position control). In the isometric FI, the slave robot starts moving with a constant speed once the foot starts exerting adequate force on one of the push buttons or adequate torque in lateral/medial axis and it stops once the force or torque is below the threshold (rate control). A single low speed is chosen for this first prototype as the laparoscopic tool is moved slowly inside the abdominal cavity to prevent unwanted collisions. A UDP connection between the input-output communication platform and the Thales controller ensures the data transfer from the master to the slave.

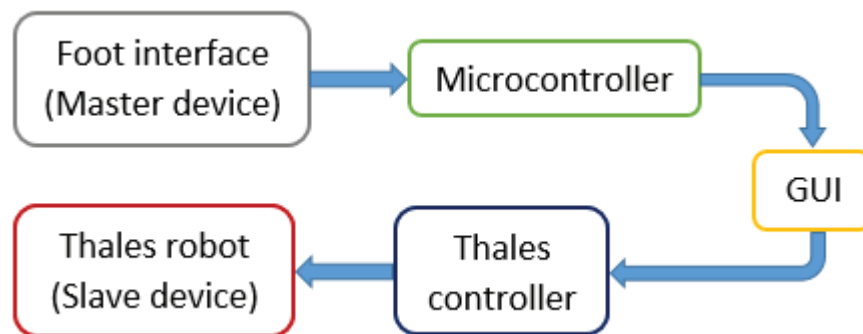


Figure 7-10 Master-slave communication platform.

### 7.3 Performance of the Two Foot Interfaces

#### Experiment

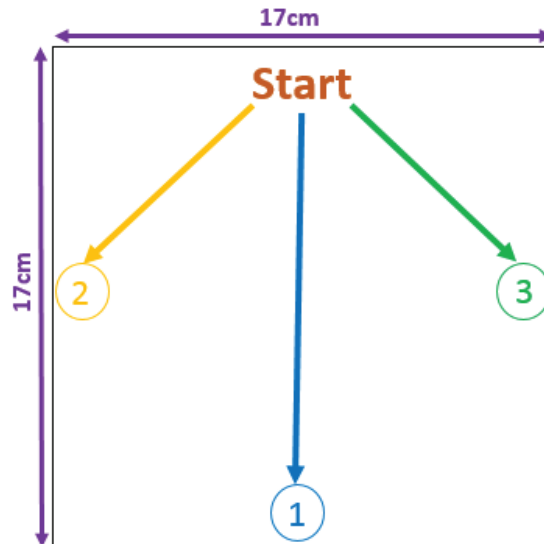
An experiment was conducted to evaluate and compare the intuitiveness and usability of the two developed foot interfaces. Six subjects (three males and three females) with mean age of  $27 \pm 0.8$  years participated in the experiment. Informed consent was obtained from every participant. The experiment took about 30 minutes for each subject including the preparation and the evaluation phases.

Each subject worked with the two interfaces, both of which could be used as the master device for controlling the Thales robot. The sequence of using the interfaces was randomized among the subjects to investigate the effect of practice.

#### Paradigm

A cylindrical camera with a diameter of 7.3mm was attached to the end effector of Thales to provide a view of the area beneath the robot. The camera provides a two dimensional view of the working space, similar to the surgeon's view from the surgical site in laparoscopic surgery. Each participant was asked to hold two surgical graspers in hands and take the two ends of a rubber cube placed in the "Start" location. Each cube has a length of 6cm with a square cross section of 0.5cm side

length. The cube had to then be transmitted along one of the three predefined paths. It should be followed through its path by the camera to keep it visible on the screen. The area that can be scanned by moving the camera is a square of 17 cm side length. The three paths are presented in Figure 7-11.



**Figure 7-11** The whole area which can be scanned by the camera attached to the Thales robot and the three predefined paths to be followed during the experiment.

Participants tried each FI for about two minutes before holding the graspers and starting the task. They had to follow each path once to complete the task. The experiment was terminated after four minutes if the goal was not reached.

The conical rotation of Thales is mapped on the DoF of the master FI dedicated to pitch. In the isotonic FI three DoFs are used instead of four due to practical considerations. That is because after performing some evaluation we concluded that the dorsiflexion/plantarflexion of the ankle (dedicated to roll) is directly coupled with the flexion/extension of the knee (dedicated to pitch) due to relatively high translational friction in this direction. Consequently, dorsiflexion/plantarflexion of the ankle is not used as a command to avoid conflict between the roll and conical rotation DoFs of the Thales robot. The camera's view on the screen is adjusted to be in the right direction before the start of the experiment. This will save the need of rolling it for adjusting the angle of view.

### Assessment

Participants filled in a questionnaire after working with each interface (Table 7.2). The questions are focused on intuitiveness of the control strategy and comfort of the user. Each statement should be ranked in an ordered response Likert scale, from -3 (for "strong disagreement") to +3 (for "strong agreement").

**Table 7.2 Questions asked after working with each FI.**

Questionnaire statements
Q1 Mapping between foot movements and robot movements were intuitive.
Q2 It was easy to control the camera by foot.
Q3 I got confused with the number of tasks that I had to perform simultaneously.
Q4 Keeping the graspers in the camera's sight was easy.
Q5 It was physically tiring for me.
Q6 It was mentally tiring for me.

After completing the task with both FIs, participants answered to a comparative questionnaire (Table 7.3). They are asked to compare the two FIs in terms of intuitiveness, imposed physical burden and general preference.

**Table 7.3 Comparative questionnaire between the two FIs.**

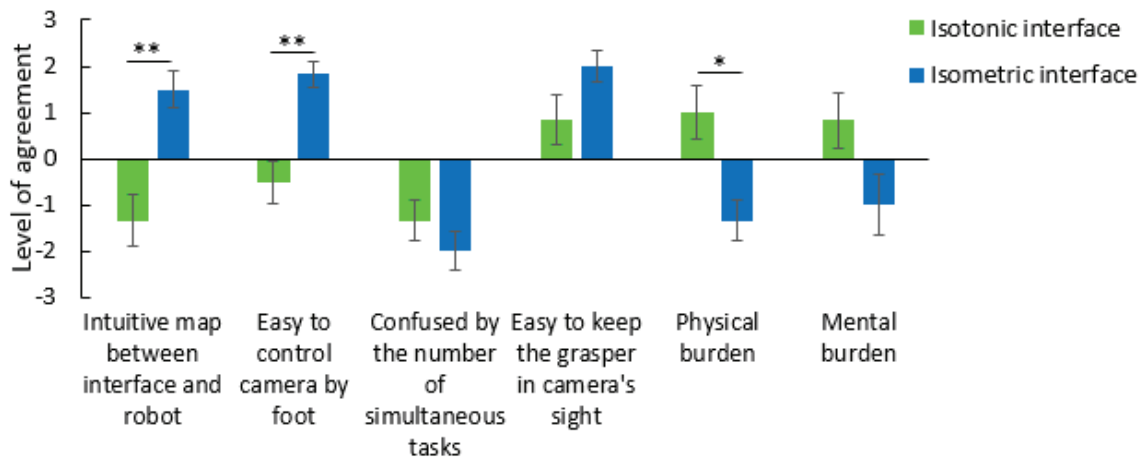
Questionnaire statements	Isotonic interface	Elastic–isometric interface
Q1 This interface is more intuitive.		
Q2 This interface is less physically tiring.		
Q3 I prefer this interface in general.		

### Statistical Analysis

The data sets are tested for normality using the Jarque-Bera test. The normally distributed data sets are compared using the t-test whereas the Wilcoxon rank sum test is used for comparison of non-normal independent sets with a significance level  $p < 5\%$ . The significant differences are reported wherever applicable. The applied method is presented in the text wherever applicable. The standard error of the mean (SEM) values are reported through the chapter and in the diagrams.

### Results

Five participants out of six managed to perform the task and follow all the three paths with both FIs in less than four minutes. One subject could cover two out of three paths in the given time. Subjective evaluation of the two FIs obtained from the questionnaires is presented in Figure 7-12. Elastic–isometric FI has been evaluated more positively in every aspect.



**Figure 7-12 Average response of all the participants to the questionnaire of Table 7.2. -3: Strong disagreement, 3: Strong agreement (SEM is represented)**

Participants believed that the mapping of DoFs between the master and the slave device was significantly more intuitive in the isometric FI (Q1, mean response: 1.5 for isometric FI vs. -1.3 for isotonic FI,  $p < 0.008$ ,  $t = -4.3320$ , t-test). Also they found it significantly easier to control the camera by foot using the isometric FI (Q2, mean response: 1.3 for isometric FI vs. -0.5 for isotonic FI,  $p < 0.006$ ,  $t = -4.7194$ , t-test). Subjects were not confused by the number of tasks they had to perform simultaneously using any of the two master devices (Q3). The confusion was less in interaction with the isometric FI (mean response: -2 for isometric FI vs. -1.3 for isotonic FI).

Participants found it easy to keep the graspers in the camera's sight during the task. Isometric FI was reported as the easier one (mean response: 2 for isometric FI vs. 0.8 for isotonic FI). Physical and mental burdens were reported to be lower while using the isometric FI compared to the other one (physical burden mean response: -1.3 for isometric FI and 1 for isotonic FI, mental burden mean response: -1 for isometric FI and 0.8 for isotonic FI). The difference between the FIs was significant for the physical burden ( $p < 0.05$ , Wilcoxon rank sum test).

Participants' responses to the comparative questionnaire are presented in Figure 7-13. All participants found the isometric interface more intuitive and less physically tiring. Also all of them preferred it over the isotonic one in general.

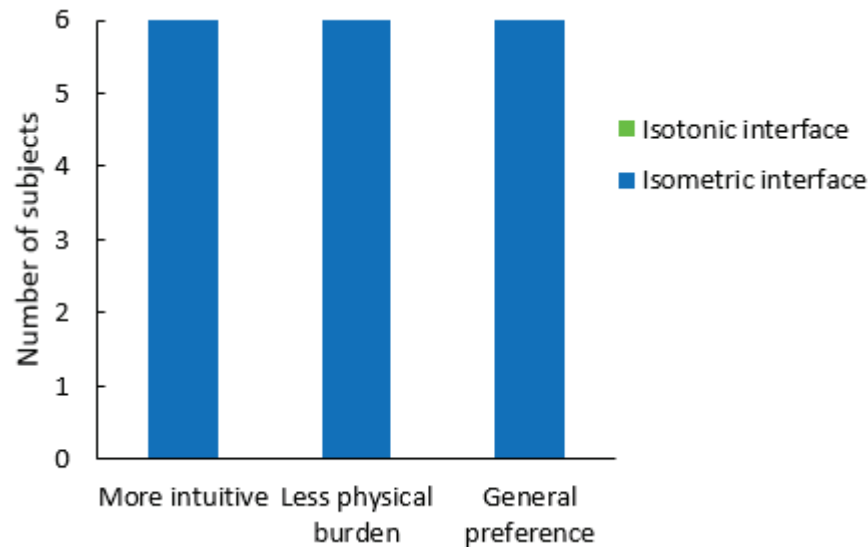


Figure 7-13 Response of participants to the comparative questionnaire of Table 7.3.

### 7.4 Discussion

After the experiments in virtual reality presented in Chapters 3 to 6, two FIs have been developed for controlling a robotic arm and are reported in this chapter. The FIs were then used in an experimental study to evaluate the performances of the implemented control strategies.

In contrast to the common planar FIs with a couple of buttons, we investigated the possibility of improving the intuitiveness of the control paradigm by means of more sophisticated interfaces. Two main control paradigms – isotonic and isometric – were compared with each other in our study. The elastic–isometric FI received an absolutely more positive feedback compared to the isotonic FI.

Apart from the responses to the questionnaires, all participants expressed orally their preference of the isometric device. In our vision, this is mainly due to two reasons. Firstly, participants reported that using the isotonic FI was physically tiring. This had a negative influence on the user’s concentration in performing the task. Secondly, position control induces some limitation in the movement accuracy of the robot. For instance, mapping of one of the foot’s translational movements to the robot’s yaw should cover all the robot’s workspace in the direction of this DoF. The proportion between the robot’s and the interface’s motion range is inversely related to the movement accuracy of the robot. The larger is this proportion, the less is the robot’s accuracy. In our case, the ranges of translational motion of 18cm on the isotonic FI is mapped on the conical rotation of the Thales around the vertical axis. This forces relatively big movements of the robot as a result of a small foot movement, to ensure the coverage of the robot’s workspace. This was a source of

## 7.5 Conclusion

---

error and inefficiency in using the isotonic FI. Table 7.4 presents the Thales robot vs. isotonic FI ranges of motion for all DOFs and the resulting movement of the robot in response to a given unit movement of the interface. It is shown that the maximum inaccuracy exists in the conical rotation around the vertical axis.

**Table 7.4 Thales robot vs. isotonic interface ranges of motion for all DoFs and the resulting movement of the robot in response to a given movement of the interface.**

Degree of freedom	Range of motion of Thales robot	Range of motion of isotonic FI	Thales movement in response to a unit movement of the isotonic FI
Pitch (Conical rotation around vertical axis)	360°	18cm	20° ~ 1cm
Yaw	60°	26cm	2.3° ~ 1cm
Roll	360°	60°	6° ~ 1°
Insertion/Withdrawal	15cm	40°	0.4cm ~ 1°

On the other hand, the isometric FI may be commanded by pressing the foot against push buttons or lateral/medial axial rotation of the foot. This requires less effort in comparison to the other device. In addition, rate control provides more flexibility in the adjustment of the movement accuracy of the slave robot. The robot moves as long as adequate force or torque is exerted and it stops otherwise. Our proposed FI and control strategy is shown to provide an intuitive commanding paradigm for control of four DOF. No other similar platform exists in the literature to the best of our knowledge.

The isotonic FI was developed to study the effect of simultaneous foot (master) and robot (slave) movement on intuitiveness of the control strategy. Our findings show that there is no direct relation between foot movement and intuitiveness. On the other hand, little physical burden and direct control on robot's movement accuracy are two influential factors on user's opinion about the master interface.

## 7.5 Conclusion

Ergonomic design of the master interface is important in intuitive control of the third robotic arm. To our knowledge this is the first study on comparing the two isotonic and isometric control strategies for a foot controlled master device. The design of two FIs, the master-slave communication platform and the control paradigm of each interface was presented in this chapter. An experimental study was conducted to compare the performance of the two interfaces while following the users' two hands by a camera attached to the robot's end effector. Although the task was completed using both interfaces in most cases, in subjective evaluation the isometric interface was selected as the more intuitive platform with less mental and physical burden.

## 7 Experiments on a Third Robotic Arm Manipulation Using Two Novel Foot Interfaces

---

Findings show that the developed isometric interface provides the possibility of an intuitive control of the robotic arm. To the best of our knowledge no foot activated master interface in the market has the capacity of controlling four DOF. The proposed FI design and control paradigm open the possibility of having a four DoFs third arm under the operators control with minimum distraction and physical burden.





## 8.1 Summary

Surgeons need assistance in most operations, from open to laparoscopic surgery and microsurgery. Besides the main intervention performed by the surgeon, complementary tasks such as keeping the organs out of the way, holding the endoscope in laparoscopic surgery, holding the third instrument used in suturing, etc. are required for a successful operation. As the surgeon has his two hands occupied holding surgical instruments, assistants are needed for these supplementary tasks. While a team of experienced and familiar surgeon-assistants can achieve a good performance, novice or assistants having not yet worked with a surgeon may be a source of error and inefficiency. In addition, the presence of numerous people in the operating room increases the risk of infection. Finally, many hospitals lack adequate personnel especially during night or holidays.

Making the surgeon able to control a supernumerary arm in addition and together with the two arms may make him more autonomous and dexterous and would reduce the need for human assistants. Therefore, this thesis investigated the possibility of having a virtual third arm under the user's own control and controlled by foot. Different behavioral experiments were designed to study the users' approach, the learning curve to use such supernumerary arm, and the appropriate level of complexity of the tasks. Although this thesis focused on the surgical applications, other industrial and rehabilitation fields may profit from the results as well.

The first experiment, presented in Chapter 3, provides a comparison between two-handed and three-handed manipulation in a demanding task. The results show that in the selected task (catching three falling objects), subjects preferred to use three

than two hands. They found it easier to complete the task with three hands and reported lower mental and physical burdens than when two hands were used. In fact, from the objective measure of number of caught objects, in the most demanding task (fastest game speed), the participants performed better with three hands. This shows that a third arm can improve performance in applications that involve handling multiple tasks in a short period of time.

Once the advantage of three-handed manipulation was shown, appropriate type of tasks for this kind of manipulation were studied in an experiment presented in Chapter 4. Users performed three different three-handed “games” in virtual reality. The tasks required different levels of motion and movement simultaneity. The third hand is continuously controlled by foot movements. The results showed that within a few minutes of practice the users find the control paradigm natural and easy. Only small physical and mental efforts were reported through the whole experiment, with an increasing sense of ownership towards the third hand. No specific order was detected in the movement of the limbs, indicating that the third hand controlled by the foot would come at a similar hierarchical level as the two hands. The level of difficulty of the task depended on the nature of the task as well as on the amount of practice received, and not directly on the amount of motion required during a game.

The next step, presented in Chapter 5, was to focus on a common task in laparoscopic surgery: holding the endoscope. This task was selected as an example of a long lasting and repetitive task in which the endoscope holder has to stay focused on the operation area and follow the surgeon’s movements. In the designed experiment participants had to move the virtual camera by foot to find the falling cubes and catch them with both hands. This is our first experiment with surgeons and medical students as participants. Their participation provided useful information about their approach towards the control strategy. Residents had the best performance. Surgeons aged between 31 to 40 years old reported the most positive subjective feedback on controlling the camera by foot. We concluded that the best time for training the surgeons to use their foot for controlling the camera is during their residency.

Our final experiment in virtual reality, described in Chapter 6, was conducted in a realistic environment resembling abdominal cavity. This virtual environment can potentially be used as a trainer for controlling the endoscope by foot in laparoscopic surgery. Participants were surgeons, residents and medical students. The sequence of the tasks designed for training was important. Performing a task which involves one hand and foot collaboration had a positive influence on performing a task which engaged two hands and foot, whereas the opposite was not true. A virtual environment, similar to surgeon’s view from the abdominal cavity in laparoscopic surgery, improved the experienced surgeons’ performance compared to a plain mono-colored environment. We confirmed our previous finding about the residency to be

the best time for training to use the third arm. In addition, our results emphasized the influence of a familiar and context related environment on the users' performance.

In Chapter 7, two foot interfaces were developed to study and compare different control strategies. One interface was based on elastic-isometric rate control (the robot is commanded via applied force or torque by the foot), and the other interface was based on isotonic position control (the robot is commanded via displacement or rotation of the foot). Both interfaces had four DoFs. A modified Thales robot with four DOFs was used as the slave robot. An experimental study similar to a task in laparoscopic surgery was conducted to compare the performance of the interfaces. The slave robot was used as the endoscope holder. Hands' movements had to be followed by the endoscope while moving an object in a predefined path. The isometric interface was preferred due to its lower physical burden and higher accuracy of the rate control. The results suggest that there is no direct relation between simultaneous foot and robot movement with intuitiveness. But little physical burden and direct control on robot's movement accuracy are two influential factors on user's opinion about the master interface.

## 8.2 Contributions

The main contributions of this thesis may be summarized in three main categories as presented in the following subsections.

### 8.2.1 Surgical Robotics

This thesis is the first systematic study on the potential third arm control in surgical applications. It provides an extensive study on the foot usage for controlling a slave robot. So far, the foot has been of limited use for controlling an assistive robot in surgical applications. In this research, the possibility of using the foot as the principle commander is studied. Two isotonic and elastic-isometric foot interfaces with four DoFs are designed to study the two control strategies. They are the most complicated foot interfaces developed for controlling a slave robot to the best of the author's knowledge. Previously developed interfaces are simply a couple of push buttons on a planar surface. Our interfaces are designed with special attention to the intuitiveness of the control to limit the mental and physical burden.

In addition, a virtual environment is developed which may be used to train the surgeons for handling the third arm. The interface can provide objective assessment of the users' performance by monitoring their movements during the training. The interface is tested with surgeons and medical students comparing their approach with that towards a simplified environment.

### 8.2.2 Cognitive Neuroscience

This thesis is the first behavioral study on the third arm collaboration with the two biological hands using subjective and objective measures. We performed a comparison between two-handed and three-handed manipulative tasks. The appropriate level of complexity of the tasks, the learning curve of the subjects and the development of sense of ownership towards the third arm are investigated for three-handed manipulations through various tasks with different levels of required motion. The effect of practice and the type of virtual environment are investigated.

Our studies highlight the control strategy selected by the central nervous system encountering a demanding task and whether the limbs are commanded in parallel or serially in a three-handed manipulation. This may serve as the basis of further research in this domain.

### 8.2.3 Other Applications

Although we focused on third arm's surgical applications in this thesis, the results can be used in other fields too. Any application that requires coordination of hands' movements between two assistants might potentially be done by only one operator and a third robotic arm. Industrial workers may benefit from a robotic arm under their own control for any application that needs large forces e.g. holding a heavy object, high precision e.g. assembling of small pieces or tolerance against hazardous conditions e.g. handling a hot or toxic material.

## 8.3 Outlook

Surgical robotics and its conjunction with cognitive neuroscience is a relatively new field of research with a huge growth potential in the future years. This thesis is the first step towards having a foot controlled robotic third arm for surgical tasks beyond the current applications. The future research can be continued in many different directions.

First, most of the experiments in this thesis are conducted in simple environments not related to surgery. The VR model of abdominal cavity, developed in Chapter 6, may be improved to be more realistic. A virtual trainer should ideally evoke the same feeling in the user as would real conditions. In addition, the effect of haptic feedback on the user's performance should be studied with a dedicated haptic device. In this thesis, the Falcon was used to provide haptic feedback on the user's hands. However, Falcon's DoFs and knob are different from the DoFs and handle of a surgical tool. This dissimilarity was disturbing for experienced surgeons. The experiment may be repeated with a more suitable haptic device to gain more accurate results.

Second, only one potential surgical application of a third arm i.e. holding the endoscope in laparoscopic surgery, is investigated in our studies. However, many other surgical as well as industrial applications may benefit from a third arm e.g. retracting an organ in the abdominal cavity, suturing tissues or assembling industrial pieces. The future work should assess the possibility of using the third arm for these applications through experimental studies. New applications may then be included in the virtual trainer. Also, apart from the applied subjective and objective measures of performance in this thesis, other measures may be used to increase the reliability of the results e.g. electrodermal activity and heart rate.

Third, the design of the foot interface may be improved to use the foot's maximum potential with minimum mental and physical burden. The two interfaces developed in this thesis are the first steps towards an intuitive foot based control strategy and may be used as a basis for further developments. For the interface to be used in the targeted surgical application, its sterility must be guaranteed. This can be addressed by either sterile covers or use of pieces and materials which can be sterilized. The interface may then be tested on a dedicated robot for surgical assistance. The Thales robot used in this thesis was suitable for the proof of concept, however it cannot be directly used in the operating room in its current status due to sterility issues and difficulty in placing the robot on the patient's abdomen.

Fourth, once the proof of concept is complete, ethical approval for medical applications should be obtained. Surgical procedures with the assistance of the third robotic arm should be tested on first animal cadavers and then live animals. If the success of the method is confirmed at this stage, human tests may be carried out as the ultimate step before commercialization of the product.

Finally, further steps may be taken to study the possibility of enhancing human's capabilities through supernumerary as well as empowered natural limbs. Study on the functionality of the brain and the central nervous system tends to indicate the ultimate capacity in controlling multiple supernumerary limbs. Further technological improvements in mechanical design, electrical circuits, composites, batteries and sensors will result in the production of more sophisticated limbs as a replacement of lost ones or as supernumerary limbs. My vision is that humans will produce limbs which surpass the natural limbs in dexterity, power and sensing capabilities. Sophisticated control strategies will be needed for controlling such artificial limbs.



# A

# Laparoscope Manipulation Using the Third Arm with Force Feedback on the Biological Hands

## A.1 Introduction

Chapter 5 presented an experimental study in a virtual environment which consisted of moving a virtual laparoscope by foot and catching the falling cubes by hands. The experiment was carried out using two Kinect cameras for tracking the hands and foot movements. This setup provided only visual feedback for the user similar to surgeons' experience in robotic surgery.

However, although in laparoscopic surgery surgeons' hands are not in direct contact with the patients' inner tissues, they have some force feedback on their hands through the surgical tools. In this appendix an experiment is presented to simulate this condition i.e. no feedback on the foot which controls the endoscope and force feedback on the two hands.

## A.2 Methods

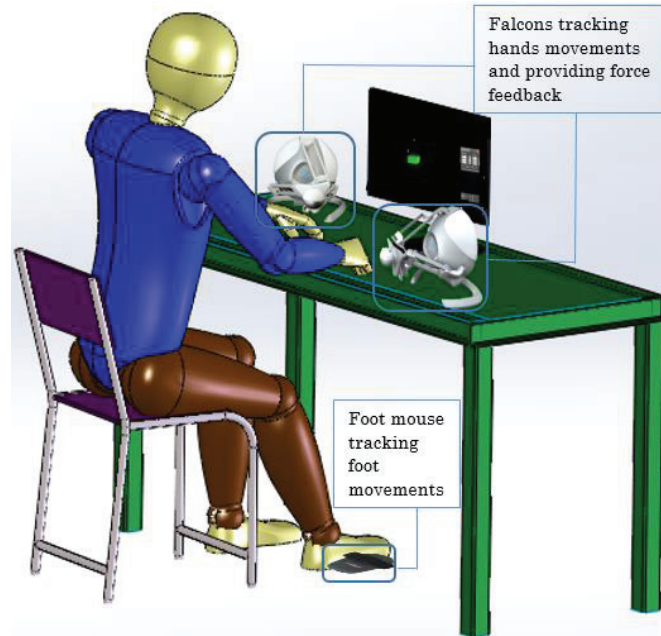
### Experiment

The participants are the same as those presented in Chapter 5. Please refer to the Methods section of that chapter.

### Setup

Figure A-1 shows the setup used for the experiment. The setup provides both visual and force feedback. Two Novint Falcon haptic devices are used to track the hands

movements and provide force feedback. Note that each hand, represented as a spherical tool in virtual reality, has movement limited to the Falcon's workspace. The foot is strapped inside the pedal of a BiLiPro foot mouse, restraining foot movements to the ground. The user's view in virtual reality can be moved laterally by moving the foot in the corresponding direction.



**Figure A-1 Setup with visual and force feedback to investigate coordinated control of the hands and one foot**

### Paradigm

The paradigm is the same as that of Chapter 5. Please refer to the Methods section of that chapter.

### Assessment

The planar position of the virtual hand representatives and the foot are recorded at a frequency of 5Hz and the movement velocities are then calculated by numerical time derivation of sampled position data. At the end of the experiment, subjects answer a set of questions about their experience as shown in Table A.1. Each statement is ranked in an ordered response Likert scale, from -3 (for “strong disagreement”) to +3 (for “strong agreement”). The third statement is a control question.

**Table A.1 Questionnaire statements filled out after the experiment.**

#### Questionnaire statements

---

**Q1** It felt natural for me to move two hands and the foot independently.

---



- 
- Q2 It was easy for me to control the camera by foot.
  - Q3 I felt as if my real hands were turning into 'virtual'.
  - Q4 I got confused with the number of tasks that I had to perform simultaneously.
  - Q5 It was physically tiring for me.
  - Q6 It was mentally tiring for me.
  - Q7 The force feedback helped me in performing the task.
- 

### Statistical Analysis

The statistical analysis is the same as that of Chapter 5. Please refer to the Methods section of that chapter.

### A.3 Results

Participants' performance and efficiency were assessed using the number of objects caught, motion smoothness, and the number of times the foot is used during the total four minutes of interaction. The period of simultaneous movement of limbs provides additional information on the control strategy used by the participants. Results are not discriminated on the basis of the participants' specialty as the population of specialists in each field is small. No influence was detected for the age, status, skill in MIS, proficiency in video game and gender factors. The detailed performance comparison of the subgroups of each factor for different performance measures are presented in the following subsections. No significant difference was detected between the subgroups for gender and proficiency in video games.

#### Caught Objects

An average of  $4.4 \pm 0.4$  objects are caught. Students with  $5.2 \pm 0.5$  caught objects were the most successful group (Figure A-2). The foot was more frequently used compared to the other setup. More than one object was caught from the same position before moving the camera to another position in only 23% of the time. This provides objective evidence that using the foot mouse is easier for participants. No pattern was detected in the order of caught objects.

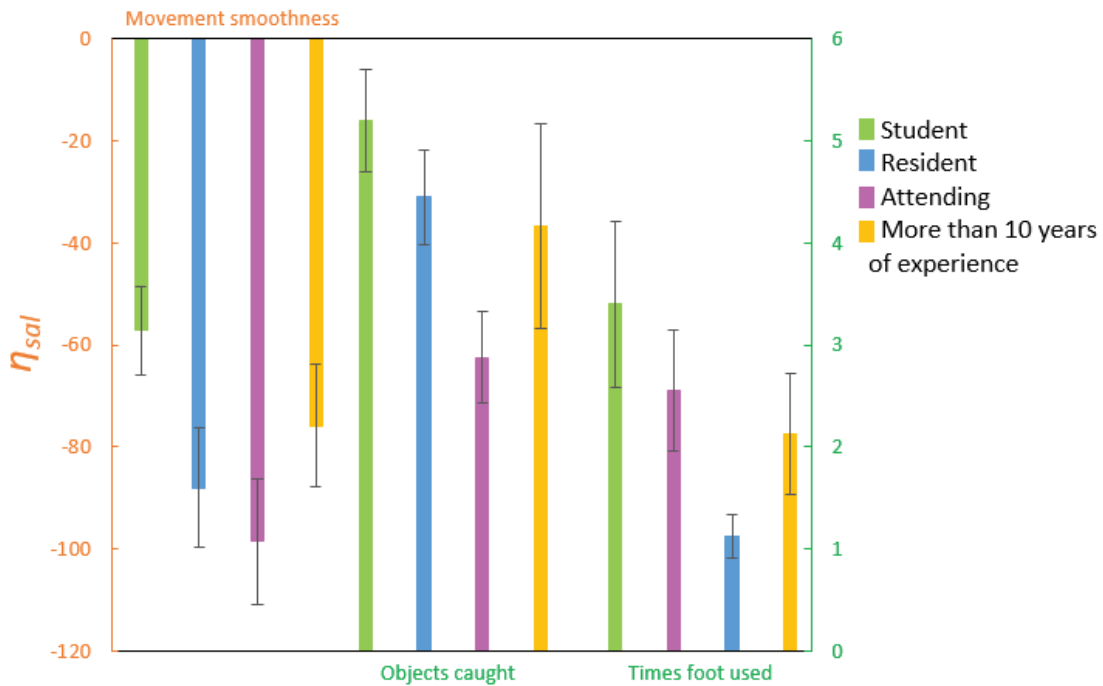


Figure A-2 Setup with Average subjects' performance in visual and force feedback setup on the basis of their medical professionalism.

### Movement Smoothness

In average over the three limbs, attending surgeons had the least smooth movements of all (Figure A-2). This difference was significant for right hand compared to residents ( $p < 0.03$ , rank sum test). Participants with the best MIS skills had the smoothest movements for all the limbs. This difference was significant for the left hand compared to the intermediately skilled surgeons ( $p < 0.02$ , rank sum test).

### Foot Movement

In average over all the subjects, the foot was moved  $2.4 \pm 0.3$  times. There was no significant difference in this category among the participants' performance (Figure A-2). However, Students used their foot for moving the camera more than the other groups, residents follow them in performance. Attending surgeons had the least number of foot movements. Surgeons with advanced skills in MIS used their foot twice more than intermediately skilled surgeons.

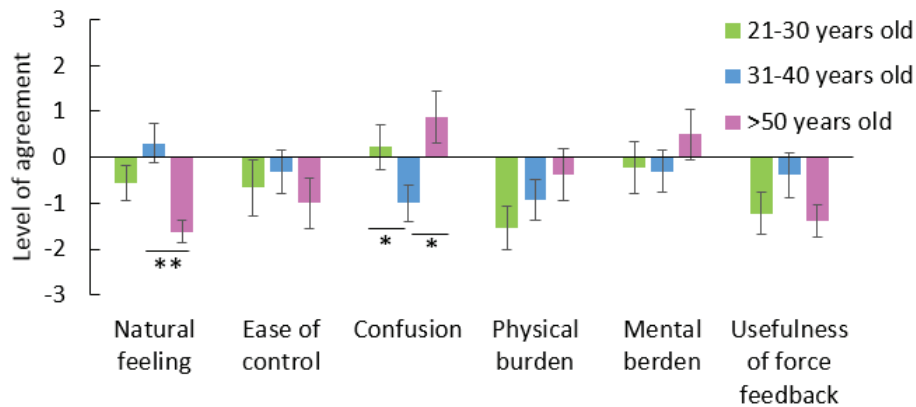
### Simultaneity of Limbs Movements

In VFF, Students moved their two hands simultaneously in 47.4% of the time whereas surgeons with more than 10 years of practice did it in 27.6% of the time ( $p < 0.02$ , rank sum test). There was no significant difference in other possible combinations of limbs movements.

### Subjective Assessment

At the end of the experiment, participants answered to a set of questions about their experiment with the setup. Statistical analysis of their answers to the questionnaire showed that participants' age had significant influence on their opinion (Pillai's trace, value=0.83,  $F=2.39$ ,  $R^2=0.2767$ ,  $p=0.011$ ). The average questionnaire ratings are compared among the subgroups of each of the three main factors. The significant differences are reported in this section.

The results of the questionnaire for the VFF setup are illustrated in Figure A-3. 31 to 40 years old participants found it more natural to control the camera by foot while performing a task with their two hands. The difference was significant between them and the surgeons older than 50 years old ( $p<0.01$ , rank sum test). The same group were also least confused by the number of tasks that they should have performed simultaneously. The difference was significant compared to 21 to 30 years old participants ( $p<0.05$ ,  $z=-2.0104$ , rank sum test) as well as surgeons older than 50 years old ( $p<0.02$ , rank sum test). Participants aged between 41 to 50 years old are not taken into account as there are only two persons in this category. Surgeons with less than 10 years of practice found it more natural to move the limbs independently compared to more experienced surgeons ( $p<0.02$ , rank sum test). Beginners found it significantly easier to control the camera by foot compared to advanced surgeons ( $p<0.04$ ,  $z=2.0614$ , rank sum test).



**Figure A-3 Average response of participants in different age categories to the questionnaire of the VFF.**

Force feedback was least helpful for students compared to more advanced participants. Even though the difference is not significant. Surgeons with more than 10 years of experience found the experience more physically tiring compared to other groups with a significant difference with residents ( $p<0.03$ ,  $z=-2.2503$ , rank sum test). There is no gender dependent difference among the participants.

## A.4 Discussion

An experimental study was conducted with thirty surgeons and medical students to investigate the possibility of controlling the endoscope by foot while performing a task with two hands. Participants have force feedback on their hands but not force feedback on the foot.

Professional laparoscopic surgeons had the smoothest movements compared to those with limited or no laparoscopic experience. The same group had the least smooth movements in VF. We conclude that having experience in tool handling makes the interaction with Falcon smoother as it is also perceived as a tool. Comparing the performance of participants with different levels of medical expertise shows that students, who had the smoothest movements, caught the highest number of objects and used their foot more than others. They are followed by residents. Attending surgeons, who had the least smooth movements, caught the least number of objects. The number of times that the foot is used decreases constantly from students to experienced surgeons.

The *foot-hand coordination performance index* ( $II_{fnc}$ ) (defined in Chapter 5) for students, residents, attending surgeons and surgeons with more than ten years of experience are 0.18, 0.16, 0.04 and 0.12 respectively. Students and residents have higher performance indexes compared to others. However, the performance index in this experiment is much lower than the experiment presented in chapter 5 with only visual feedback. We conclude that the proposed setup for having the force feedback is not well adapted to our application.

Participants aged between 31 to 40 years old - 64% of whom are residents and the rest surgeons with less than five years of practice- have the most positive approach towards the control strategy. They found it more natural and easy to control three limbs simultaneously and independently. They were also least confused by the number of tasks they had to perform simultaneously and reported less mental burden. Residents are mentally flexible enough to accept new solutions and they have already gained some experience in the operating room with the endoscope which helps them during the experiment. It is trivial that the physical burden is age dependent. It is also the case in our experiment i.e. the more senior the subjects are, the more physically tired they get during the experiment. However, mental burden does not follow the same age dependent trend. Participants aged between 31 to 40 years old reported the highest mental burden.

Although the presented setup provides visual and haptic feed, the gripper of Novint Falcon used for providing the force feedback is not designed as surgical handles, this is confusing for experienced surgeons who are used to that kind of instrument and environment. Also, the restricted workspace of the Novint Falcon affects

participants' performance. Unfavorable feedbacks on the corresponding experimental setup can be partially due to this deficiency.

## **A.5 Conclusion**

We confirm our conclusion of chapter 5 that residents and junior faculty are better in adapting the new technique for moving the endoscope. However, according to participants, although the Falcon can provide force feedback, a dedicated haptic device for laparoscopy with more intuitive workspace may be more suitable for training purposes. Otherwise, a setup without force feedback, like the one proposed in chapter 5 with no restraint on the limbs' movements, is more favorable.



## Bibliography

- [1] J. H. Shim, J. G. Kim, H. M. Jeon, C. H. Park, and K. Y. Song, "The Robotic Third Arm as a Competent Analog of an Assisting Surgeon in Radical Gastrectomy: Impact on Short-Term Clinical Outcomes," *Journal of Laparoendoscopic & Advanced Surgical Techniques*, vol. 23, pp. 447-451, May 2013.
- [2] D. H. Jung, S.-Y. Son, Y. S. Park, D. J. Shin, H. S. Ahn, S.-H. Ahn, *et al.*, "The learning curve associated with laparoscopic total gastrectomy," *Gastric Cancer*, vol. 19, pp. 264-272, Jan 2016.
- [3] M. Nurok, T. M. Sundt, and A. Frankel, "Teamwork and Communication in the Operating Room: Relationship to Discrete Outcomes and Research Challenges," *Anesthesiology Clinics*, vol. 29, pp. 1-11, 2011.
- [4] L. Lingard, R. Reznick, S. Espin, G. Regehr, and I. DeVito, "Team communications in the operating room: Talk patterns, sites of tension, and implications for novices," *Academic Medicine*, vol. 77, pp. 232-237, Mar 2002.
- [5] K. K. Shirley A. Elprama, Pieter Duysburgh, An Jacobs, "Identifying barriers in telesurgery by studying current team practices in robot-assisted surgery," in *COST workshop*, 2013.
- [6] S.-Y. K. a. J. K. Dong-Soo Kwon, "Intelligent Laparoscopic Assistant Robot through Surgery Task Model: How to Give Intelligence to Medical Robots," in *Medical Robotics*, V. Bozovic, ed: I-Tech Education and Publishing, 2008.
- [7] "Human Factors Actions and Interventions," in *Handbook of Aviation Human Factors*, J. A. Wise, V. D. Hopkin, and D. J. Garland, Eds., Second Edition ed: CRC Press, 2009.
- [8] T. Kimura, Y. Umehara, and S. Matsumoto, "Laparoscopic cholecystectomy performed by a single surgeon using a visual field tracking camera - Early experience," *Surgical Endoscopy-Ultrasound and Interventional Techniques*, vol. 14, pp. 825-829, Sep 2000.
- [9] P. Hourlay, "How to maintain the quality of laparoscopic surgery in the era of lack of hands ?," *Acta Chirurgica Belgica*, vol. 106, pp. 22-26, Feb 2006.

- [10] A. Arezzo, F. Ulmer, O. Weiss, M. O. Schurr, M. Hamad, and G. F. Buess, "Experimental trial on solo surgery for minimally invasive therapy - Comparison of different systems in a phantom model," *Surgical Endoscopy- Ultrasound and Interventional Techniques*, vol. 14, pp. 955-959, Oct 2000.
- [11] A. G. Gallagher and C. D. Smith, "From the operating room of the present to the operating room of the future. Human-factors lessons learned from the minimally invasive surgery revolution," *Seminars in laparoscopic surgery*, vol. 10, pp. 127-39, 2003-Sep 2003.
- [12] W. Glenn, "Minimally Invasive Surgical Robotics," in *Minimally Invasive Medical Technology*, ed: Taylor & Francis, 2001, pp. 195-218.
- [13] A. Rane, S. Kommu, B. Eddy, P. Rimington, and C. Anderson, "Initial experience with the endoassist (R) camera holding robot in laparoscopic urological surgery," *European Urology Supplements*, vol. 6, pp. 186-186, Mar 2007.
- [14] P. A. Finlay and M. H. Ornstein, "Controlling the movement of a surgical laparoscope - endosista(tm) with 4 degrees of freedom, operates in concert with surgeons intuitive head motions," *IEEE Engineering in Medicine and Biology Magazine*, vol. 14, pp. 289-291, May-Jun 1995.
- [15] Y. Yavuz, B. Ystgaard, E. Skogvoll, and R. Marvik, "A comparative experimental study evaluating the performance of surgical robots aesop and endosista," *Surgical laparoscopy, endoscopy & percutaneous techniques*, vol. 10, pp. 163-7, 2000-Jun 2000.
- [16] K. Tadano and K. Kawashima, "A pneumatic laparoscope holder controlled by head movement," *International Journal of Medical Robotics and Computer Assisted Surgery*, vol. 11, pp. 331-340, Sep 2015.
- [17] S. W. Unger, H. M. Unger, and R. T. Bass, "AESOP robotic arm," *Surgical Endoscopy*, vol. 8, p. 1131, 1994.
- [18] H. Niebuhr and O. Born, "Image Tracking System. A new technique for safe and cost-effective laparoscopic surgery," *Chirurg*, vol. 71, pp. 580-584, May 2000.
- [19] R. Polet and J. Donnez, "Gynecologic laparoscopic surgery with a palm-controlled laparoscope holder," *Journal of the American Association of Gynecologic Laparoscopists*, vol. 11, pp. 73-78, Feb 2004.
- [20] P. Berkelman, P. Cinquin, E. Boidard, J. Troccaz, C. Letoublon, and J.-A. Long, "Development and testing of a compact endoscope manipulator for minimally invasive surgery," *Computer aided surgery : official journal of the International Society for Computer Aided Surgery*, vol. 10, pp. 1-13, 2005-Jan 2005.
- [21] A. Mirbagheri, F. Farahmand, B. Ghanadi, K. Amini Khoiy, S. Porsa, M. J. Shamsollahi, *et al.*, "Operation and Human Clinical Trials of RoboLens: an Assistant Robot for Laparoscopic Surgery," *Frontiers in Biomedical Technologies*, vol. 2, pp. 172-178, November 2015.



- [22] H. Reichenspurner, R. J. Damiano, M. Mack, D. H. Boehm, H. Gulbins, C. Detter, *et al.*, "Use of the voice-controlled and computer-assisted surgical system ZEUS for endoscopic coronary artery bypass grafting," *Journal of Thoracic and Cardiovascular Surgery*, vol. 118, pp. 11-16, Jul 1999.
- [23] J. Dagan and L. Bat, "EndoAssist, a mechanical device to support an endoscope," *Gastrointestinal Endoscopy*, vol. 28, pp. 97-98, 1982.
- [24] G. T. Sung, I. S. Gill, and T. H. S. Hsu, "Robotic-assisted laparoscopic pyeloplasty: A pilot study," *Urology*, vol. 53, pp. 1099-1103, Jun 1999.
- [25] V. Bozovic, *Medical Robotics* vol. 1: I-Tech Education and Publishing, 2008.
- [26] T. Drasin, E. Dutson, and C. Gracia, "Use of a robotic system as surgical first assistant in advanced laparoscopic surgery," *Journal of the American College of Surgeons*, vol. 199, pp. 368-373.
- [27] L. R. Kavoussi and R. G. Moore, "Comparison of robotic versus human laparoscopic camera control (vol 154, pg 2134, 1995)," *Journal of Urology*, vol. 158, pp. 1530-1530, Oct 1997.
- [28] L. Mettler, M. Ibrahim, and W. Jonat, "One year of experience working with the aid of a robotic assistant (the voice-controlled optic holder AESOP) in gynaecological endoscopic surgery," *Human Reproduction*, vol. 13, pp. 2748-2750, Oct 1998.
- [29] M. M. Rahman, R., "The Camera-holding Robotic Device in Laparoscopy Surgery," *World Journal of Laparoscopic Surgery*, vol. 4, pp. 132-135, 2011.
- [30] A. A. Wagner, I. M. Varkarakis, R. E. Link, W. Sullivan, and L. M. Su, "Comparison of surgical performance during laparoscopic radical prostatectomy of two robotic camera holders, EndoAssist and AESOP: A pilot study," *Urology*, vol. 68, pp. 70-74, Jul 2006.
- [31] P. Berkelman, P. Cinquin, E. Boidard, J. Troccaz, C. Letoublon, and J. M. Ayoubi, "Design, control and testing of a novel compact laparoscopic endoscope manipulator," *Proceedings of the Institution of Mechanical Engineers Part I-Journal of Systems and Control Engineering*, vol. 217, pp. 329-341, 2003 2003.
- [32] J. A. Long, P. Cinquin, J. Troccaz, S. Voros, P. Berkelman, J. L. Descotes, *et al.*, "Development of miniaturized light endoscope-holder robot for laparoscopic surgery," *Journal of Endourology*, vol. 21, pp. 911-914, Aug 2007.
- [33] P. Berkelman, E. Boidard, P. Cinquin, and J. Troccaz, *From the laboratory to the operating room: Usability testing of LER, the light endoscope robot*, 2004.
- [34] R. Polet and J. Donnez, "Using a laparoscope manipulator (LAPMAN) in laparoscopic gynecological surgery," *Surgical technology international*, vol. 17, pp. 187-91, 2008 2008.

- [35] J. Kim, Y.-J. Lee, S.-Y. Ko, D.-S. Kwon, and W.-J. Lee, "Compact camera assistant robot for minimally invasive surgery: KaLAR," in *IROS*, 2004, pp. 2587-2592.
- [36] S. Voros, G. P. Haber, J. F. Menudet, J. A. Long, and P. Cinquin, "ViKY Robotic Scope Holder: Initial Clinical Experience and Preliminary Results Using Instrument Tracking," *IEEE-ASME Transactions on Mechatronics*, vol. 15, pp. 879-886, Dec 2010.
- [37] J.-A. Long, J. Tostain, C. Lanchon, S. Voros, M. Medici, J.-L. Descotes, *et al.*, "First Clinical Experience in Urologic Surgery with a Novel Robotic Lightweight Laparoscope Holder," *Journal of Endourology*, vol. 27, pp. 58-63, Jan 2013.
- [38] A. Mirbagheri, F. Farahmand, A. Meghdari, and F. Karimian, "Design and development of an effective low-cost robotic cameraman for laparoscopic surgery: RoboLens," *Scientia Iranica*, vol. 18, pp. 105-114, Feb 2011.
- [39] J. H. Palep, "Robotic assisted minimally invasive surgery," *Journal of Minimal Access Surgery*, vol. 5, pp. 1-7, 2009.
- [40] J.-U. Stolzenburg, T. Franz, P. Kallidonis, D. Minh, A. Dietel, J. Hicks, *et al.*, "Comparison of the FreeHand (R) robotic camera holder with human assistants during endoscopic extraperitoneal radical prostatectomy," *Bju International*, vol. 107, pp. 970-974, Mar 2011.
- [41] D. Putzer, S. Klug, M. Haselbacher, E. Mayr, and M. Nogler, "Retracting Soft Tissue in Minimally Invasive Hip Arthroplasty Using a Robotic Arm: A Comparison Between a Semiactive Retractor Holder and Human Assistants in a Cadaver Study," *Surgical Innovation*, vol. 22, pp. 500-507, Oct 2015.
- [42] M. O. Schurr, A. Arezzo, B. Neisius, H. Rininsland, H. U. Hilzinger, J. Dorn, *et al.*, "Trocar and instrument positioning system TISKA - An assist device for endoscopic solo surgery," *Surgical Endoscopy-Ultrasound and Interventional Techniques*, vol. 13, pp. 528-531, May 1999.
- [43] J. Bosma, A. B. Kruger, and J. Jaspers, "A novel, intuitive instrument positioner for endoscopy, involving surgeons in design and feasibility," *Minimally Invasive Therapy & Allied Technologies*, vol. 24, pp. 326-333, Nov 2 2015.
- [44] J. E. N. Jaspers, P. Breedveld, J. L. Herder, and C. A. Grimbergen, "Camera and instrument holders and their clinical value in minimally invasive surgery," *Surgical Laparoscopy Endoscopy & Percutaneous Techniques*, vol. 14, pp. 145-152, Jun 2004.
- [45] F. Voorhorst, D. Meijer, C. Overbeeke, and G. Smets, "Depth perception in laparoscopy through perception-action coupling," *Minimally Invasive Therapy & Allied Technologies*, vol. 7, pp. 325-334, Sep 1998.
- [46] M. E. Allaf, S. V. Jackman, P. G. Schulam, J. A. Cadeddu, B. R. Lee, R. G. Moore, *et al.*, "Laparoscopic visual field. Voice vs foot pedal interfaces for control of the AESOP robot," *Surg Endosc*, vol. 12, pp. 1415-8, Dec 1998.

- [47] A. Knoll, H. Mayer, C. Staub, and R. Bauernschmitt, "Selective automation and skill transfer in medical robotics: a demonstration on surgical knot-tying," *International Journal of Medical Robotics and Computer Assisted Surgery*, vol. 8, pp. 384-397, Dec 2012.
- [48] E. Bauzano, V. F. Muñoz, and I. Garcia-Morales, "Auto-guided movements on minimally invasive surgery for surgeon assistance," Taipei, 2010, pp. 1843-1848.
- [49] E. Bauzano, I. Garcia-Morales, P. del Saz-Orozco, J. C. Fraile, and V. F. Muñoz, "A minimally invasive surgery robotic assistant for HALS-SILS techniques," *Computer Methods and Programs in Biomedicine*, 2013.
- [50] S. M. Khadem, S. Behzadipour, A. Mirbagheri, and F. Farahmand, "A modular force-controlled robotic instrument for minimally invasive surgery – efficacy for being used in autonomous grasping against a variable pull force," *The International Journal of Medical Robotics and Computer Assisted Surgery*, 2016.
- [51] A. Shademan, R. S. Decker, J. D. Opfermann, S. Leonard, A. Krieger, and P. C. W. Kim, "Supervised autonomous robotic soft tissue surgery," *Science Translational Medicine*, vol. 8, pp. 337ra64-337ra64, 2016.
- [52] B. Llorens-Bonilla, F. Parietti, and H. H. Asada, "Demonstration-based control of supernumerary robotic limbs," in *Intelligent Robots and Systems (IROS), 2012 IEEE/RSJ International Conference on*, 2012, pp. 3936-3942.
- [53] B. Llorens-Bonilla, H. H. Asada, and Asme, "Control and coordination of supernumerary robotic limbs based on human motion detection and task petri net model," *Asme 2013 Dynamic Systems and Control Conference, Vol 2*, 2013 2013.
- [54] F. Parietti, H. H. Asada, and IEEE, "Dynamic Analysis and State Estimation for Wearable Robotic Limbs Subject to Human-Induced Disturbances," in *2013 IEEE International Conference on Robotics and Automation*, ed, 2013, pp. 3880-3887.
- [55] C. Davenport, F. Parietti, and H. H. Asada, "Design and biomechanical analysis of supernumerary robotic limbs," *ASME 2012 5th Annual Dynamic Systems and Control Conference Joint with the JSME 2012 11th Motion and Vibration Conference, DSCC 2012-MOVIC 2012*, vol. 1, pp. 787-793, 2012.
- [56] F. Parietti and H. Asada, "Supernumerary Robotic Limbs for Human Body Support," *IEEE Transactions on Robotics*, vol. 32, pp. 301-311, Apr 2016.
- [57] P. K. Artemiadis and K. J. Kyriakopoulos, "EMG-Based Control of a Robot Arm Using Low-Dimensional Embeddings," *IEEE Transactions on Robotics*, vol. 26, pp. 393-398, Apr 2010.
- [58] P. Kutilek, J. Hybl, J. Kauler, and S. Viteckova, *Prosthetic 6-DOF Arm Controlled by EMG Signals and Multi-Sensor System*. Prague 6: Czech Technical Univ Prague, 2012.

- [59] E. P. Lana, B. V. Adorno, C. J. Tierra-Criollo, and IEEE, "An ERD/ERS Analysis of the Relation between Human Arm and Robot Manipulator Movements," in *2013 Iessnip Biosignals and Biorobotics Conference*, ed New York: IEEE, 2013, pp. 73-79.
- [60] N. Martens, R. Jenke, M. Abu-Alqumsan, C. Kapeller, C. Hintermuller, C. Guger, *et al.*, "Towards Robotic Re-Embodiment using a Brain-and-Body-Computer Interface," in *2012 IEEE/Rsj International Conference on Intelligent Robots and Systems*, ed New York: IEEE, 2012, pp. 5131-5132.
- [61] C. Lopez, P. Halje, and O. Blanke, "Body ownership and embodiment: Vestibular and multisensory mechanisms," *Neurophysiologie Clinique-Clinical Neurophysiology*, vol. 38, pp. 149-161, Jun 2008.
- [62] M. Botvinick and J. Cohen, "Rubber hands 'feel' touch that eyes see," *Nature*, vol. 391, pp. 756-756, Feb 1998.
- [63] A. Guterstam, V. I. Petkova, and H. H. Ehrsson, "The Illusion of Owning a Third Arm," *Plos One*, vol. 6, Feb 2011.
- [64] A. Guterstam, G. Gentile, and H. H. Ehrsson, "The Invisible Hand Illusion: Multisensory Integration Leads to the Embodiment of a Discrete Volume of Empty Space," *Journal of Cognitive Neuroscience*, vol. 25, pp. 1078-1099, Jul 2013.
- [65] M. Slater, D. Perez-Marcos, H. H. Ehrsson, and M. V. Sanchez-Vives, "Towards a digital body: the virtual arm illusion," *Frontiers in Human Neuroscience*, vol. 2, Aug 2008.
- [66] G. Gentile, A. Guterstam, C. Brozzoli, and H. H. Ehrsson, "Disintegration of Multisensory Signals from the Real Hand Reduces Default Limb Self-Attribution: An fMRI Study," *Journal of Neuroscience*, vol. 33, pp. 13350-13366, Aug 14 2013.
- [67] G. Gentile, V. I. Petkova, and H. H. Ehrsson, "Integration of Visual and Tactile Signals From the Hand in the Human Brain: An fMRI Study," *Journal of Neurophysiology*, vol. 105, pp. 910-922, Feb 2011.
- [68] H. H. Ehrsson, C. Spence, and R. E. Passingham, "That's my hand! Activity in premotor cortex reflects feeling of ownership of a limb," *Science*, vol. 305, pp. 875-877, Aug 6 2004.
- [69] A. Maselli and M. Slater, "The building blocks of the full body ownership illusion," *Frontiers in Human Neuroscience*, vol. 7, Mar 2013.
- [70] S. I. Shokur, Peter; Lebedev, A. Mikhail; Bleuler, Hannes; Nicolelis, Miguel, "Social interaction probed by reaching to face images: Rhesus monkeys consider a textured monkey avatar as a conspecific," presented at the society for Neuroscience, Washington DC, USA, 2011.
- [71] D. Perez-Marcos, M. Slater, and M. V. Sanchez-Vives, "Inducing a virtual hand ownership illusion through a brain-computer interface," *Neuroreport*, vol. 20, pp. 589-594, Apr 2009.

- [72] L. Bashford and C. Mehring, "Ownership and Agency of an Independent Supernumerary Hand Induced by an Imitation Brain-Computer Interface," *Plos One*, vol. 11, Jun 2016.
- [73] M. Riemer, X. Fuchs, F. Bublatzky, D. Kleinboehl, R. Hoelzl, and J. Trojan, "The rubber hand illusion depends on a congruent mapping between real and artificial fingers," *Acta Psychologica*, vol. 152, pp. 34-41, Oct 2014.
- [74] L. E. Miller, M. R. Longo, and A. P. Saygin, "Tool Morphology Constrains the Effects of Tool Use on Body Representations," *Journal of Experimental Psychology-Human Perception and Performance*, vol. 40, pp. 2143-2153, Dec 2014.
- [75] M. Bertamini and N. O'Sullivan, "The use of realistic and mechanical hands in the rubber hand illusion, and the relationship to hemispheric differences," *Consciousness and Cognition*, vol. 27, pp. 89-99, Jul 2014.
- [76] R. Newport, R. Pearce, and C. Preston, "Fake hands in action: embodiment and control of supernumerary limbs," *Experimental Brain Research*, vol. 204, pp. 385-395, Jul 2010.
- [77] A. Folegatti, A. Farne, R. Salemme, and F. de Vignemont, "The Rubber Hand Illusion: Two's a company, but three's a crowd," *Consciousness and Cognition*, vol. 21, pp. 799-812, Jun 2012.
- [78] S. Crea, M. D'Alonzo, N. Vitiello, and C. Cipriani, "The rubber foot illusion," *Journal of Neuroengineering and Rehabilitation*, vol. 12, Sep 4 2015.
- [79] B. van der Hoort, A. Guterstam, and H. H. Ehrsson, "Being Barbie: The Size of One's Own Body Determines the Perceived Size of the World," *Plos One*, vol. 6, May 25 2011.
- [80] A. v. E. Sengul, M.; Rognini, G.; Aspell, J. E.; Bleuler, H.; Blanke, O., "Extending the Body to Virtual Tools Using a Robotic Surgical Interface: Evidence from the Crossmodal Congruency Task," *Plos One*, vol. 7, Dec 2012.
- [81] M. J. Giummarra, S. J. Gibson, N. Georgiou-Karistianis, and J. L. Bradshaw, "Mechanisms underlying embodiment, disembodiment and loss of embodiment," *Neuroscience and Biobehavioral Reviews*, vol. 32, pp. 143-160, 2008.
- [82] A. Senguel, G. Rognini, M. van Elk, J. E. Aspell, H. Bleuler, and O. Blanke, "Force feedback facilitates multisensory integration during robotic tool use," *Experimental Brain Research*, vol. 227, pp. 497-507, Jun 2013.
- [83] G. Di Pino, A. Maravita, L. Zollo, E. Guglielmelli, and V. Di Lazzaro, "Augmentation-related brain plasticity," *Frontiers in systems neuroscience*, vol. 8, pp. 109-109, 2014 2014.
- [84] S. Shibuya, S. Unenaka, and Y. Ohki, "Is this my hand? Body-ownership and the rubber hand illusion," *The Journal of Physical Fitness and Sports Medicine*, vol. 4, pp. 213-216, 2015.



- [85] D. Escobar-Castillejos, J. Noguez, L. Neri, A. Magana, and B. Benes, "A Review of Simulators with Haptic Devices for Medical Training," *Journal of Medical Systems*, vol. 40, Apr 2016.
- [86] R. Khan, A. Aydin, M. S. Khan, P. Dasgupta, and K. Ahmed, "Simulation-based training for prostate surgery," *Bju International*, vol. 116, pp. 665-674, Oct 2015.
- [87] M. Classen and H. Ruppin, "Practical endoscopy training using a new gastrointestinal phantom," *Endoscopy*, vol. 6, pp. 127-131, 1974.
- [88] J. Maiss, L. Millermann, K. Heinemann, A. Naegel, A. Peters, K. Matthes, *et al.*, "The compactEASIE (R) is a feasible training model for endoscopic novices: A prospective randomised trial," *Digestive and Liver Disease*, vol. 39, pp. 70-78, Jan 2007.
- [89] A. Ende, Y. Zopf, P. Konturek, A. Naegel, E. G. Hahn, K. Matthes, *et al.*, "Strategies for training in diagnostic upper endoscopy: a prospective, randomized trial," *Gastrointestinal Endoscopy*, vol. 75, pp. 254-260, Feb 2012.
- [90] N. King, A. Kunac, and A. M. Merchant, "A Review of Endoscopic Simulation: Current Evidence on Simulators and Curricula," *Journal of Surgical Education*, vol. 73, pp. 12-23, Jan-Feb 2016.
- [91] J. Olasky, G. Sankaranarayanan, N. E. Seymour, J. H. Magee, A. Enquobahrie, M. C. Lin, *et al.*, "Identifying Opportunities for Virtual Reality Simulation in Surgical Education: A Review of the Proceedings from the Innovation, Design, and Emerging Alliances in Surgery (IDEAS) Conference: VR Surgery," *Surgical Innovation*, vol. 22, pp. 514-521, Oct 2015.
- [92] J. L. Gutierrez-Banos, R. Ballester-Diego, D. Truan-Cacho, C. Aguilera-Tubet, A. Villanueva-Pena, and J. C. Manuel-Palazuets, "Training of urology residents in laparoscopic surgery preparation of a virtual reality model," *Actas Urologicas Espanolas*, vol. 39, pp. 564-572, Nov 2015.
- [93] D. Stefanidis, N. Sevdalis, J. Paige, B. Zevin, R. Aggarwal, T. Grantcharov, *et al.*, "Simulation in Surgery What's Needed Next?," *Annals of Surgery*, vol. 261, pp. 846-853, May 2015.
- [94] J. J. Pan, J. Chang, X. Yang, H. Liang, J. J. Zhang, T. Qureshi, *et al.*, "Virtual reality training and assessment in laparoscopic rectum surgery," *International Journal of Medical Robotics and Computer Assisted Surgery*, vol. 11, pp. 194-209, Jun 2015.
- [95] K. W. M. See, K. H. Chui, W. H. Chan, K. C. Wong, and Y. C. Chan, "Evidence for Endovascular Simulation Training: A Systematic Review," *European journal of vascular and endovascular surgery : the official journal of the European Society for Vascular Surgery*, vol. 51, pp. 441-51, 2016-Mar 2016.
- [96] R. E. Sedlack and J. C. Kolars, "Computer simulator training enhances the competency of gastroenterology fellows at colonoscopy: Results of a pilot study," *American Journal of Gastroenterology*, vol. 99, pp. 33-37, Jan 2004.

- [97] S. Kim, B. J. Dunkin, J. T. Paige, J. M. Eggerstedt, C. Nicholas, M. C. Vassiliou, *et al.*, "What is the future of training in surgery? Needs assessment of national stakeholders," *Surgery*, vol. 156, pp. 707-717, Sep 2014.
- [98] M. Tsakiris, L. Carpenter, D. James, and A. Fotopoulou, "Hands only illusion: multisensory integration elicits sense of ownership for body parts but not for non-corporeal objects," *Experimental Brain Research*, vol. 204, pp. 343-352, Jul 2010.
- [99] S. Balasubramanian, A. Melendez-Calderon, and E. Burdet, "A Robust and Sensitive Metric for Quantifying Movement Smoothness," *IEEE Transactions on Biomedical Engineering*, vol. 59, pp. 2126-2136, Aug 2012.
- [100] J. Moeller, "A word on standardization in longitudinal studies: don't," *Frontiers in Psychology*, vol. 6, Sep 15 2015.
- [101] E. Abdi, Bouri, M., Himidan, S., Burdet, E., Bleuler, H., "Third arm for surgeon: two hands versus three hands CARS 2015—Computer Assisted Radiology and Surgery Proceedings of the 29th International Congress and Exhibition Barcelona, Spain, June 24–27, 2015," *International Journal of Computer Assisted Radiology and Surgery*, vol. 10, pp. 170-171, 2015.
- [102] R. L. J. Meesen, N. Wenderoth, J. J. Temprado, J. J. Summers, and S. P. Swinnen, "The coalition of constraints during coordination of the ipsilateral and heterolateral limbs," *Experimental Brain Research*, vol. 174, pp. 367-375, Sep 2006.
- [103] K. Nakagawa, T. Muraoka, and K. Kanosue, "Factors that determine directional constraint in ipsilateral hand-foot coordinated movements," *Physiological reports*, vol. 1, pp. e00108-e00108, Oct 2013.
- [104] K. Nakagawa, T. Muraoka, and K. Kanosue, "Potential explanation of limb combination performance differences for two-limb coordination tasks," *Physiological reports*, vol. 3, Feb 2015.
- [105] T. L. McIsaac and B. Benjapalakorn, "Allocation of attention and dual-task effects on upper and lower limb task performance in healthy young adults," *Experimental Brain Research*, vol. 233, pp. 2607-2617, Sep 2015.
- [106] A. L. Simeone, E. Velloso, J. Alexander, and H. Gellersen, "Feet Movement in Desktop 3D Interaction," *2014 IEEE Symposium on 3d User Interfaces (3dUI)*, pp. 71-74, 2014.
- [107] E. Abdi, E. Burdet, M. Bouri, and H. Bleuler, "Control of a Supernumerary Robotic Hand by Foot: An Experimental Study in Virtual Reality," *PLoS ONE*, vol. 10, p. e0134501, 2015.
- [108] M.-V. Aponte, G. Levieux, and S. Natkin, "Scaling the Level of Difficulty in Single Player Video Games," in *Entertainment Computing - Icec 2009*. vol. 5709, S. Natkin and J. Dupire, Eds., ed, 2009, pp. 24-35.

- [109] E. F. Ritter and L. J. Schooler, "The Learning Curve," in *International Encyclopedia of the Social and Behavioral Sciences*, ed Oxford, UK: Pergamon, 2002.
- [110] S. Jones, L. Nyberg, J. Sandblom, A. Stigsdotter Neely, M. Ingvar, K. Magnus Petersson, *et al.*, "Cognitive and neural plasticity in aging: General and task-specific limitations," *Neuroscience & Biobehavioral Reviews*, vol. 30, pp. 864-871, 2006.
- [111] L.-H. Chang, K. Shibata, G. J. Andersen, Y. Sasaki, and T. Watanabe, "Age-Related Declines of Stability in Visual Perceptual Learning," *Current Biology*, vol. 24, Dec 2014.
- [112] F. J. Massey, "The Kolmogorov-Smirnov test for goodness of fit," *Journal of the American Statistical Association*, vol. 46, pp. 68-78, 1951 1951.
- [113] H. Kazemi, J. K. Rappel, T. Poston, B. H. Lim, E. Burdet, and C. L. Teo, "Assessing suturing techniques using a virtual reality surgical simulator," *Microsurgery*, vol. 30, pp. 479-486, Sep 2010.
- [114] M. Uemura, M. Tomikawa, R. Kumashiro, T. Miao, R. Souzaki, S. Ieiri, *et al.*, "Analysis of hand motion differentiates expert and novice surgeons," *Journal of Surgical Research*, vol. 188, pp. 8-13, 2014.
- [115] M. O. N. Trudeau, A. Nasr, B. Carrillo, J. T. Gerstle, and G. Azzie, "Construct validity and educational role for motion analysis in a laparoscopic trainer," *Surgical Endoscopy and Other Interventional Techniques*, vol. 29, pp. 2491-2495, Sep 2015.
- [116] E. Hiemstra, M. K. Chmarra, J. Dankelman, and F. W. Jansen, "Intracorporeal Suturing: Economy of Instrument Movements Using a Box Trainer Model," *Journal of Minimally Invasive Gynecology*, vol. 18, pp. 494-499, Jul-Aug 2011.
- [117] E. Abdi, Bouri, M., Himidan, S., Burdet, E., Bleuler, H, "Third Arm Manipulation for Surgical Applications: An Experimental Study," in *New Trends on Medical and Service Robots: Challenges and Solutions*, Springer, Ed., ed, 2015.
- [118] E. Abdi, E. Burdet, M. Bouri, S. Himidan, and H. Bleuler, "In a demanding task, three-handed manipulation is preferred to two-handed manipulation," *Scientific Reports*, vol. 6, p. 21758, 2016.
- [119] J. Guna, G. Jakus, M. Pogacnik, S. Tomazic, and J. Sodnik, "An Analysis of the Precision and Reliability of the Leap Motion Sensor and Its Suitability for Static and Dynamic Tracking," *Sensors*, vol. 14, pp. 3702-3720, Feb 2014.
- [120] S. Balasubramanian, A. Melendez-Calderon, A. Roby-Brami, and E. Burdet, "On the analysis of movement smoothness," *Journal of NeuroEngineering and Rehabilitation*, vol. 12, pp. 1-11, 2015.



- [121] J. Van Patten, I. C. Chun, and C. M. Reigeluth, "A Review of Strategies for Sequencing and Synthesizing Instruction," *Review of Educational Research*, vol. 56, pp. 437-471, 1986.
- [122] J. M. Gilbert, "The EndoAssist (TM) robotic camera holder as an aid to the introduction of laparoscopic colorectal surgery," *Annals of the Royal College of Surgeons of England*, vol. 91, pp. 389-393, Jul 2009.
- [123] M. Pfister, J.-C. L. Lue, F. R. Stefanini, P. Falabella, L. Dustin, M. J. Koss, *et al.*, "Comparison of reaction response time between hand and foot controlled devices in simulated microsurgical testing," *BioMed research international*, vol. 2014, pp. 769296-769296, 2014 2014.
- [124] Y. Hama and S. Kosuda, "Foot pedal-activated injector for contrast-enhanced sonography," *Journal of Clinical Ultrasound*, vol. 33, pp. 457-459, Dec 2005.
- [125] I. Diaz, J. J. Gil, and M. Louredo, "A haptic pedal for surgery assistance," *Computer Methods and Programs in Biomedicine*, vol. 116, pp. 97-104, Sep 2014.
- [126] M. Malosio, M. Caimmi, M. Ometto, and L. M. Tosatti, "Ergonomics and kinematic compatibility of PKankle, a fully-parallel spherical robot for ankle-foot rehabilitation," in *5th IEEE RAS/EMBS International Conference on Biomedical Robotics and Biomechatronics*, 2014, pp. 497-503.
- [127] A. Agrawal, S. K. Banala, S. K. Agrawal, and S. A. Binder-Macleod, "Design of a two degree-of-freedom ankle-foot orthosis for robotic rehabilitation," in *9th International Conference on Rehabilitation Robotics, 2005. ICORR 2005.*, 2005, pp. 41-44.
- [128] M. C. Carrozza, A. Persichetti, C. Laschi, F. Vecchi, R. Lazzarini, P. Vacalebri, *et al.*, "A wearable biomechatronic interface for controlling robots with voluntary foot movements," *IEEE-ASME Transactions on Mechatronics*, vol. 12, pp. 1-11, Feb 2007.
- [129] S. Zhai, "Human Performance in Six Degree of Freedom Input Control," PhD, Industrial Engineering, University of Toronto, 1995.
- [130] P. Pham, Y.-J. Regamey, and R. Clavel, "Delta Thales, a novel architecture for an orientating device with fixed RCM (remote center of movement) and linear movement in direction of the RCM," presented at the PKS Parallel Kinematics Seminar Chemnitz 2006, Chemnitz, 2006.
- [131] R. Clavel, P. Pham, B. Lorent, B. Le Gall, and M. Bouri, "New Variants of Delta Robots and Double-Tilt Platform for Assembly," in *3rd International Colloquium of the Collaborative Research Center*, Braunschweig, Germany, 2008, pp. 237-249.
- [132] R. Clavel, "Conception d'un robot parallèle rapide à 4 degrés de liberté," EPFL, 1991.



# Curriculum Vitae

**ELAHE ABDI**

Laboratory of Robotic Systems (LSRO)  
École Polytechnique Fédérale de Lausanne (EPFL)

Date of Birth : 6<sup>th</sup> of February, 1987

Place of Birth: Tehran, Iran

E-mail: abdi.elahe@gmail.com

## Education

---

- |      |  |
|------|--|
| 2016 | <b>Ph.D. in Robotics</b> , <i>Swiss Federal Institute of Technology (EPFL)</i> , Switzerland.<br><b>Thesis:</b> Supernumerary Robotic Arm for Three-Handed Surgical Application: Behavioral Study and Design of Human-Machine Interface. |
| 2012 | <b>Master of Science in Biomechanical Engineering</b> , <i>Sharif University of Technology</i> , Tehran, Iran.<br><b>Thesis:</b> Model Based Control of a Laparoscopic Instrument for Safe and Effective Grasping of Spleen Tissue.      |
| 2009 | <b>Bachelor of Science in Mechanical Engineering</b> , <i>University of Tehran</i> , Tehran, Iran.   |

## Professional Experience

---

- |           |   |
|-----------|---|
| 2012-2016 | <b>Doctoral assistant</b> , Laboratory of Robotic Systems (LSRO)-EPFL, Lausanne, Switzerland.<br>Interdisciplinary research in collaboration with Imperial College London and University of Toronto.<br>Teaching and supervision of master and semester projects<br>Member of organizing committee (web manager) of MESROB 2014 international conference, EPFL. |
|-----------|---|

## Research Interests

---

- Mechanical design and control of medical robots.
- Development of virtual environments for medical training and experiments.
- Design of control strategies and experiments.

## Language Skills:

---

- English (Fluent, TOEFL IBT: 109/120, FCE: A)
- French (Intermediate, B2)
- German (Elementary, A2)
- Persian (Native)

## Awards and Scientific Recognitions

---

- |      |  |
|------|--|
| 2015 | Won a two years full fund from Sanovica (a Canadian organization) for the continuation of Ph.D.  |
| 2014 | Received a prime prize for exceptional work for 3000CHF from LSRO, EPFL.   |
| 2009 | Ranked 140 <sup>th</sup> among nearly 13000 participants in the Nation Wide Universities Entrance Exam for MSc Degree in Mechanical Engineering, Iran. |
| 2005 | Ranked 332 <sup>nd</sup> among nearly 400,000 participants in Nation Wide University Entrance Exam for BSc degree, Iran.                               |

## Publications

---

### Book Chapters

---

- 1- Bouri M, **Abdi E**, Bleuler H, Reynard F, Deriaz O. Lower Limbs Robotic Rehabilitation Case Study with Clinical Trials. In: Rodić A, Pisla D, Bleuler H, editors. *New Trends in Medical and Service Robots: Challenges and Solutions*. Cham: Springer International Publishing; 2014. p. 31-44.
- 2- **Abdi E**, Bouri M, Himidan S, Burdet E, Bleuler H. Third Arm Manipulation for Surgical Applications: An Experimental Study. In: Bleuler H, Bouri M, Mondada F, Pisla D, Rodic A, Helmer P, editors. *New Trends in Medical and Service Robots: Assistive, Surgical and Educational Robotics*. Cham: Springer International Publishing; 2016. p. 153-63.

### Journal Papers

---

- 1- **Abdi E**, Farahmand F, Durali M. A meshless EFG-based algorithm for 3D deformable modeling of soft tissue in real-time. *Stud Health Technol Inform*. 2012;173:1-7. PubMed PMID: 22356947. Epub 2012/02/24. eng.
- 2- **Abdi E**, Burdet E, Bouri M, Bleuler H. Control of a Supernumerary Robotic Hand by Foot: An Experimental Study in Virtual Reality. *PLoS ONE*. 2015;10(7):e0134501.
- 3- Nooshabadi ZS, **Abdi E**, Farahmand F, Narimani R, Chizari M. A meshless method to simulate interactions between large soft tissue and a surgical grasper. *Scientia Iranica*. 2016;23(1):295-300. PubMed PMID: WOS:000371008800013.
- 4- **Abdi E**, Burdet E, Bouri M, Himidan S, Bleuler H. In a demanding task, three-handed manipulation is preferred to two-handed manipulation. *Scientific Reports*. 2016 02/25/online;6:21758.
- 5- **Abdi E**, Burdet E, Bouri M, Bleuler H, Himidan S. Foot-hand coordination in surgical applications: Residents and junior faculty are better learners than experienced surgeons. Submitted to *Surgical Endoscopy*. 2016.
- 6- **Abdi E**, Bouri M, Burdet E, Himidan S, Bleuler H. Positioning the endoscope in laparoscopic surgery by foot: influential factors of surgeons' performance in virtual trainer. 2016 (in preparation).

## Conference Proceedings and Posters

---

- 1- **Abdi E**, Bouri M, Burdet E, Bleuler H, Third Arm for Surgeon: Embodiment Study in Virtual Reality. Hand, Brain and Technology, CSF Conference, Monte Verità, September 7-12, 2014.
- 2- **Abdi E**, Bouri M, Burdet E, Bleuler H, Embodiment of a third arm for surgeon: Experimental study with haptic feedback. Asia Haptics 2014, Tsukuba, Japan, 2014.
- 3- **Abdi E**, Bouri M, Burdet E, Bleuler H, Third arm for surgeon: Embodiment and Control, CRAS 2014, Genoa, Italy, 2014.
- 4- **Abdi E**, Himidan S, Bouri M, Bleuler H, Third Arm for Surgeon: Feasibility and Applications, IPEG 2015, Nashville, Tennessee, USA, 2015.
- 5- **Abdi E**, Bouri M, Himidan S, Burdet E, Bleuler H, editors. Third Arm for Surgeon: Two Hands Vs. Three Hands, CARS 2015, Barcelona, Spain, June 24-27, 2015.
- 6- **Abdi E**, Olivier J, Bouri M, Bleuler H, Foot-Controlled Endoscope Positioner for Laparoscopy: Development of the Master and Slave Interfaces. IEEE International Conference on Robotics and Mechatronics, Tehran, Iran, October 26-28, 2016.