

# Experimental investigation on seismic behaviour of slab-column connections

Ioannis-Sokratis Drakatos, Katrin Beyer, Aurelio Muttoni

*School of Architecture, Civil and Environmental Engineering  
École Polytechnique Fédérale de Lausanne,  
Station 18 CH-1015, Switzerland  
Supervisors: Prof. Dr. Katrin Beyer, Prof. Dr. Aurelio Muttoni*

## Abstract

Code design of slab-column connections to resist seismically induced drifts is currently based on empirical relationships for both moment and deformation capacity. The results of tests on slab-column connections are however sensitive to the conception of the test setup. This paper presents a new setup configuration as well as first results of an experimental campaign carried out at EPFL. Within this campaign slabs without shear reinforcement will be subjected to constant vertical loads and increasing seismic moments. Parameters investigated are the vertical loads, the longitudinal reinforcement content of the slabs, the column size and the loading history (monotonic vs. cyclic). Results of the first three out of sixteen tests showed that the drift capacity of relatively thick slabs is smaller when compared to thinner ones tested by other researchers [7]. The influence of the gravity induced shear force on the seismic moment and deformation capacity of the connections is found to be well pronounced. A comparison of a monotonic and cyclic test for high vertical loads showed that the deformation capacity of the cyclically loaded slab is smaller than of the monotonically loaded one.

## 1 Introduction

In many countries with moderate seismic risk reinforced concrete (RC) flat slabs supported on columns is one of the most commonly used structural systems for office and industrial buildings since it features several advantages (large open floor spaces, short construction times). To increase the lateral stiffness and strength of the structure, RC walls are typically added which carry the largest portion of the horizontal loads generated during earthquakes. While the slab-column system is not relevant with regard to the lateral stiffness and strength of the structure, each slab-column connection has to have the capacity to follow the seismically induced lateral displacements of the building while maintaining its capacity to transfer vertical loads from the slab to the columns. If this is not the case, the deformation capacity of the entire building is limited by the deformation capacity of the slab-column connection and brittle punching failure of the slab occurs.

Design approaches in codes of practice [1, 3] are empirical relationships derived from experimental works for both moment and deformation capacity. This paper reviews setup configurations adopted by other researchers including a short discussion on their advantages and disadvantages. Afterwards, a new setup configuration is presented. In addition, the results of the first three tests of an experimental campaign comprising in total 16 tests are presented. The principal objective of the campaign is to assess the influence of the reinforcement ratio, column size, gravity induced shear forces and loading history (monotonic vs. cyclic) on the drift capacity and punching strength degradation of slab-column connections without transverse reinforcement. The comparisons presented herein concern the influence of the gravity induced shear force and the cyclic loading conditions on the seismic behaviour of slab-column connections, notably in comparison with the results obtained by other researchers.

## 2 Setup configurations of previous experimental research

Most test programs on the behaviour of slab-column connections subjected to an unbalanced moment considered test specimens representing a single interior column and the surrounding slab. The dimensions of the specimens for the monotonic tests were typically chosen as  $0.44L$  where  $L$  is the

distance between column axes [5]. The distance  $0.22L$  corresponds for an elastic slab under an evenly distributed load to the distance of the point of contraflexure to the column axis. The point of contraflexure of the seismically induced moment is typically around the midspan. For experimental campaigns under gravity and seismically induced moments, it was often assumed that the point of contraflexure in the slab is located at midspan of the slab [4]. The latter was predominantly applied to cyclic tests, with few exceptions [6].

For tests on a single interior slab-column connection different test setups were developed concerning the slab and column boundary conditions as well as the way lateral loads were simulated. However, all test setups can be assigned to one of the following three schemes (Figure 1):

- Test setup A: the unbalanced moment is introduced by an eccentric vertical load and by restraining the vertical displacement of the slab ends [2].
- Test setup B: the unbalanced moment is introduced by applying unequal vertical loads to the ends of the slab and by restraining the horizontal displacement of the column stub ends [5].
- Test setup C: the unbalanced moment is introduced by applying a horizontal force to the top column stub and by restraining the vertical displacement of the slab ends [7].

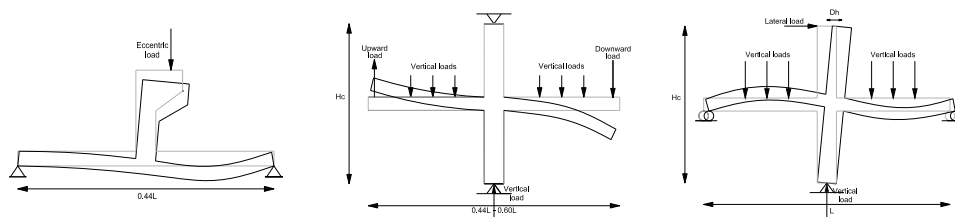

Fig. 1 Test setup configurations used in previous experimental campaigns for slab-column connections with moment transfer

Setup A is predominantly adopted to simulate unbalanced moments due to unequal spans. Advantageous of this setup is its simplicity when compared to the other configurations. However, when applied to simulate seismic loading, it is somewhat unrealistic as the eccentricity remains constant throughout the test.

Depending on the control of the actuators inducing the forces at the slab ends, Setup B can be used to simulate either constant eccentricity [5] or constant vertical load [4]. Significant rigid body rotations are introduced to the slab-column connection as a result of the column deformation, which increase the displacement demand on the actuators applying the force couple at the ends of the slab.

Setup C is predominantly used for cyclic tests on slab-column connections. It is based on the assumption that the contraflexure points are located at midspan of the slab. The test unit size and the reaction structure for the lateral load application impose significant space requirements for laboratories requiring therefore sometimes testing at reduced scales. Cracking of the slab results in significant redistribution of the vertical load from the column to the slab ends, particularly for high eccentricities, and continuous adjustment is needed so that the force carried by the column remains constant.

### 3 EPFL tests on slab-column connection under gravity and seismic loads

#### 3.1 Prototype building

The prototype building that served as a reference for the design of the test specimen was a multi-story office building typical for Swiss construction. The slab had a thickness of 250 mm and internal and external spans of 7.2 m and 5.4 m respectively. The story height was 3 m. The primary lateral load-resisting system in both directions is typically comprised either of RC cores or shear walls arranged in the building perimeter (Fig. 2), whereas slab-column connections were designed to carry only vertical loads. The columns were square and cast-in-place with a size of 390 mm. The reinforcement ratio activated by lateral forces in each direction was equal to 0.75% in the zone of the slab near the

column (1.5 m from the column's centre) and 0.5% in the middle strip. Bottom reinforcement was provided in both directions over the column, with a ratio equal to 50% of the top reinforcement ratio. The quasi-permanent vertical loads consisted of  $6.25 \text{ kN/m}^2$  of self-weight of the slab,  $1.00 \text{ kN/m}^2$  superimposed load and  $0.60 \text{ kN/m}^2$  quasi-permanent live load. Under this load combination, the shear force ratio was approximately half the nominal strength according to ACI 318 [1].

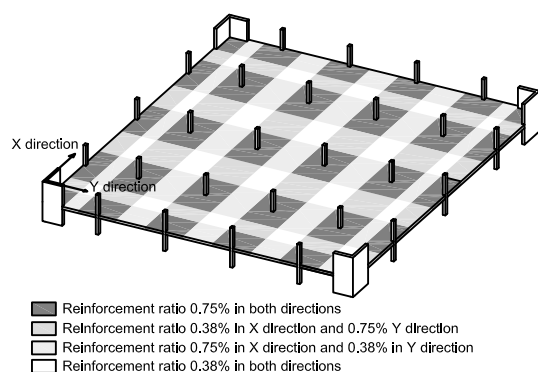

Fig. 2 Three-dimensional view of a story of the prototype building

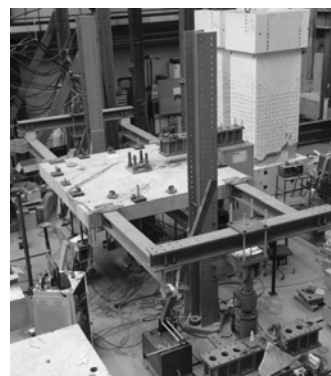

Fig. 3 Slab-column test unit in test setup before load application

### 3.2 Setup configuration and specimen properties

The test specimen was intended to represent at full scale an internal slab-column connection of the prototype building with the surrounding slab. The dimensions of the isolated specimen are  $3.0 \text{ m} \times 3.0 \text{ m}$  and the slab thickness is  $250 \text{ mm}$ . Slab's top reinforcement consisted of  $16 \text{ mm}$  deformed bars per direction with  $100 \text{ mm}$  spacing, whereas for the bottom mat  $10 \text{ mm}$  deformed bars were spaced at  $125 \text{ mm}$  in each direction. The reinforcement layer with the bigger lever arm was perpendicular to the moment vector. The nominal effective depth was  $210 \text{ mm}$  and the average reinforcement ratio was  $0.75\%$  for the top mat and  $0.38\%$  for the bottom mat for all specimens presented herein. The concrete cover was  $20 \text{ mm}$  for both top and bottom mat and the maximum aggregate size was  $16 \text{ mm}$ . The compressive strength of concrete (determined by compression tests on concrete cylinders) and the prescribed yield stress of reinforcing steel are reported in Table 1.

The column consisted of a welded profile with three webs parallel to the vector of the inserted moment, designed to resist a moment of  $1.3 \text{ MNm}$ . At the position of the column, the slab was clamped down to a support plate. A prestressing of the slab region under the support plate had to be applied to limit rigid body rotations of the slab. The amount of prestressing was  $1.2 \text{ MN}$  and was applied using 4 threaded bars passing through holes inside the slab (Fig. 4).

The vertical loads corresponding to the total gravity load induced shear force transmitted to an internal connection of the prototype structure were applied at eight points arranged at a radius of  $1.50 \text{ m}$  ( $= 0.21L$ ). The effects of seismically induced drifts were simulated by applying two equal and opposite vertical forces by means of two actuators (Fig. 4). The actuators were connected to steel beams that were in turn connected to the slab edges. The lever arm of the force couple was  $7.2 \text{ m}$  which corresponds to the midspan-to-midspan distance in the prototype building. Zones near the edges parallel to the direction of excitation were provided with additional reinforcement to account for the part of the slab that was not modelled. The additional reinforcement consisted of four threaded bars (diameter equal to  $30 \text{ mm}$ ) per zone and was necessary to avoid the formation of global mechanisms and to connect the slab to the steel frames for the moment application.

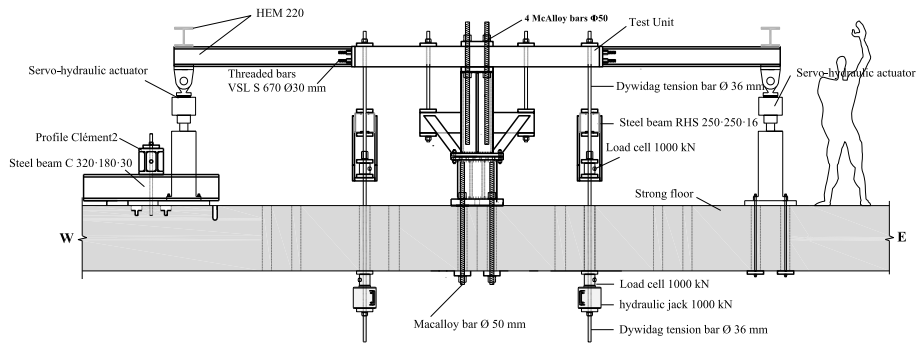

Fig. 4 Setup elevation perpendicular to the inserted moment vector

The bottom face of specimens was instrumented with displacement transducers and strain gauges to measure deflections along the axis perpendicular to the moment vector and concrete deformations. On the top face eight inclinometers were positioned on the slab to record rotations in different directions and one was positioned on the top steel plate to measure the column rotation. After the zero measurements the vertical load was applied by means of four hydraulic jacks each one applying the same load on two points on the slab (Fig. 4). Then, the steel frames were connected to the servo-hydraulic actuators and an increasing unbalanced moment was applied in several load steps. Their force was controlled to keep the same magnitude, but in opposite direction.

For the specimens PD1 and PD3 the moment was monotonically increased until failure. For the specimen PD2, which was subjected to cyclic loading, the displacement-controlled and force-controlled actuators were alternated at each cycle. The control parameter was the drift rotation, defined as the mean value of the inclinometers West and East minus the value of the column rotation (measured using an inclinometer on the top plate). Two cycles were applied per drift level. Throughout the moment application the vertical load was controlled to remain constant for all tests.

#### 4 Results

As outlined in the introduction to this paper, only the first three out of 16 tests had been completed when writing this paper. The most important results of these three tests in terms of moment and deformation capacity for the tests conducted by the authors are summarised in Table 1 (columns 6 and 7).

Table 1 Table resuming the material properties, the loading parameters as well as the most important results obtained from the tests carried out by the authors

Test Unit	Material properties		Loading parameters		Results	
	$f_c$ [MPa]	$f_y$ [MPa]	Vertical load [kN]	Moment application	Ultimate moment [kNm]	Drift rotation [%]
PD1	37.9	550	253	Monotonic	526	1.88
PD2	36.9	550	734	Cyclic	166	0.40
PD3	34.9	550	734	Monotonic	200	0.51

The cracking pattern of the top surface of the specimens is shown in Figure 5. The specimen with less vertical load (PD1) showed very limited cracking during the vertical load application. During the moment application, extensive cracking was observed in the part of the slab subjected to negative moment due to lateral loading. On the contrary, specimens PD2 and PD3 that were subjected to

approximately three times higher vertical load than PD1 showed extensive cracking during the vertical load application. Moment application provoked growth of already existing cracks.

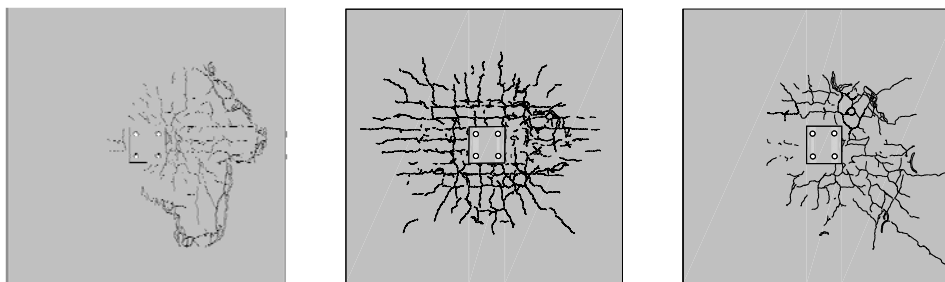

Fig. 5 Cracking pattern of the top surface of specimens PD1 (left), PD2 (centre), and PD3 (right)

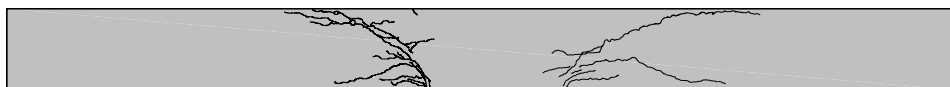

Fig. 6 Sawcut of PD1 along the bending axis

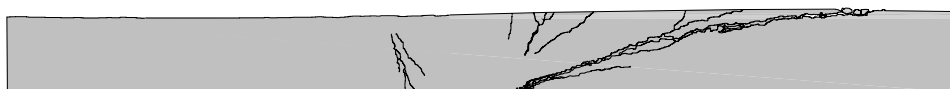

Fig. 7 Sawcut of PD1 along the axis perpendicular to the moment vector

The saw cut of slab PD1 along the axis parallel to the moment vector (Fig. 6) suggests that the radius of the shear crack is approximately equal to the effective depth of the slab, as proposed by Muttoni [8] for punching of RC slabs under vertical loading. The saw cut along the axis perpendicular to the moment vector (Fig.7) shows that in the region inside the critical shear crack significant flexural and diagonal cracking occurred when applying the seismic moment through the force couple. Moreover, the shear crack was significantly flatter compared to its orthogonal direction (Fig. 6).

#### 4.1 Gravity load effect

For the case of slab-column connections subjected to a combination of vertical load and unbalanced moment, the level of vertical load influences significantly the moment-rotation response of the connection. This effect is reflected in the three most important parameters of the response i.e. the strength, the stiffness and the rotation capacity. An increase in the vertical load acting on the connection results in a lower strength, ductility and stiffness as cracking due to the opening of the shear crack becomes more predominant on the flexural behavior of the slab-column connection under increasing unbalanced moment. This effect was observed by Pan and Moehle [7] among others and is confirmed by the results of the tests conducted by the authors on relatively thick slabs (Fig. 8). In addition, the gravity load effect is observed for both monotonic and cyclic application of moment as can be seen from monotonic moment-rotation curves (Fig. 8 – left) and backbone moment-rotation curves (Fig. 8 – right). It should be noted that with increasing slab thickness the moment capacity is increasing whereas the deformation capacity is decreasing (Fig. 8).

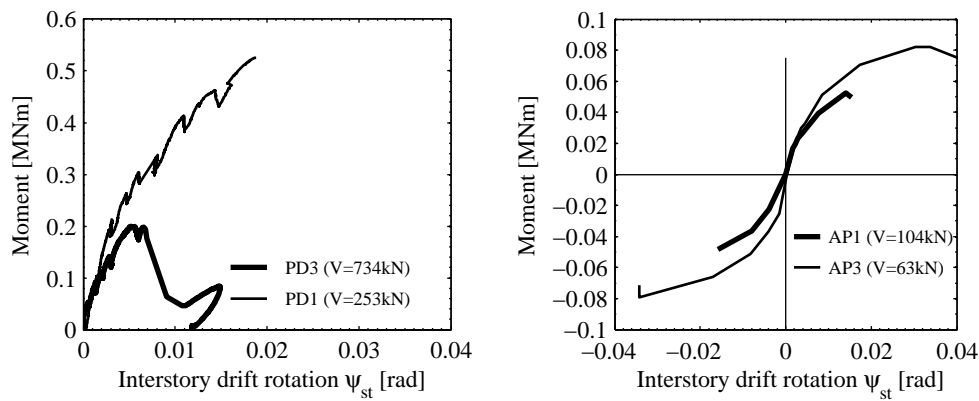

Fig. 8 Gravity load effect on slab-column connections under seismically induced deformations: (left) tests (slab thickness of 250 mm), and (right) Pan and Moehle [7] (slab thickness of 122 mm)

#### 4.2 Degradation due to cyclic loading

The effect of cyclic rotations that are imposed to a slab-column connection during an earthquake motion is extensively studied in previous experimental studies [6, 7]. The mechanisms that provoke degradation can be addressed by comparing results from monotonic and cyclic tests. The database of pairs of slab-column specimens under monotonic and cyclic imposed rotation is, however, limited and does not cover cases of flat slab connections under high vertical loads.

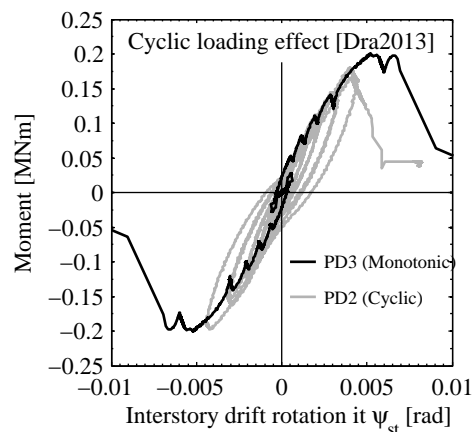

Fig. 9 Influence of cyclic loading in the moment and deformation capacity for slab-column connections tested by the authors (for the monotonic test the same moment-rotation relationship is drawn on both sides)

As shown in Figure 9, cyclic loading influences the response of slab-column connections. For the specimen PD2, failure was observed during the application of the 2<sup>nd</sup> cycle at 0.4% of drift rotation at side east for a moment equal to 166 kNm. Therefore, a decrease of 20% in the deformation capacity and 17% in the moment capacity when compared to slab PD3 was observed. It should be noted that the maximum moment during the application of the 1<sup>st</sup> cycle at this drift level was 180 kNm for the east side and 197 kNm for the west side. The presence of a wide shear crack under vertical loading alone suggests that the degradation of the mechanism of aggregate interlocking is significant with

reversed moment loading. Cyclic and monotonic pairs of tests under vertical loads that are closer to engineering practice will provide more insight into the cyclic behavior of slab-column connections.

## 5 Conclusions and Outlook

A new setup for investigating experimentally the behaviour of slab-column connections under seismically induced drifts is presented. The results of the first three tests of a large experimental campaign are also presented and discussed. The presence of a shear crack with different inclination at different angles was observed.

The influence of the moment and deformation capacity of slab-column connections by the gravity induced shear was confirmed also for relatively thick slabs, as well as the increased moment capacity and limited deformation capacity comparing to thinner slabs. The effect of cyclic loading was found to be significant for high vertical loading as a drop of about 20% in the moment and deformation capacity was observed comparing to the monotonic counterpart.

The remaining part of the test program consists in investigating the influence of the slab reinforcement ratio, column size, gravity induced shear and cyclic loading on the behaviour, moment and deformation capacity of slab-column connection. The objective of the overall investigation is the development of a mechanical model that accounts for the aforementioned parameters and predicts the response and capacity of slab-column connections under seismically induced drifts.

## Acknowledgements

The present investigation, funded by the Swiss National Science Foundation, is gratefully acknowledged.

## References

- [1] ACI: Building code requirements for structural concrete (ACI 318-11) and commentary (ACI 318R-11). American Concrete Institute(2011), 473 p.
- [2] Elstner, R.C., Hognestad, E.: Shearing strength of reinforced concrete slabs. *ACI Materials Journal* (1956) No. 2, pp. 29-58
- [3] Eurocode 2: Design of concrete structures – Part 1-1: General rules and rules for buildings. CEN, EN 1992-1-1 (2004), 225 p.
- [4] Hanson, N.W., Hanson, J.M.: Shear and moment transfer between concrete slabs and columns. *Journal of the Portland Cement Association, Research and Development Laboratories* (1968) No. 1, pp. 2-16
- [5] Hawkins, N.M., Bao, A., Yamazaki, J.: Moment transfer from concrete slabs to columns. In: *ACI Structural Journal* (1989) No. 6, pp. 705-716
- [6] Hawkins, N.M., Mitchell, D., Sheu, M.S.: Cyclic behaviour of six reinforced concrete slab-column specimens transferring moment and shear. Progress report 1973-74 on NSF Project GI-38717 (1974) No. 6, 143 p.
- [7] Pan, A., Moehle, J.P.: Lateral displacement ductility of reinforced concrete flat plates. *ACI Structural Journal* (1989) No. 3, pp. 250-258
- [8] Muttoni, A.: Punching shear strength of reinforced concrete slabs without transverse reinforcement. *ACI Structural Journal* (2008) No. 4, pp. 440-450