

Flow exchange between a channel and a rectangular embayment equipped with a diverting structure

Jean-Marc Ribí, Jean-Louis Boillat & Anton J. Schleiss

Laboratory of Hydraulic Constructions (LCH), Ecole Polytechnique Fédérale de Lausanne (EPFL), Station 18, CH-1015 Lausanne, Switzerland.

ABSTRACT: In the framework of a research project focusing on mitigation measures for hydropeaking, a lateral embayment in riverbank is studied as a fish shelter. With the goal to find attractive configurations of shelter, systematic experiments with wild juvenile brown trout (*Salmo trutta fario*) were carried out in a flume supplied with freshwater from a natural river. The experimental is equipped with a rectangular lateral embayment. In order to follow the fish trajectories, their movements were recorded continuously by video camera during every test, and their positions were periodically observed. In order to link the swimming trajectories of the trout with the flow conditions, 2D simulations were computed to obtain the diverted discharge in the shelter, and systematic UVP measurement of the velocity field was performed. The flow velocities were analysed in the vertical interface between the shelter and the flume. Comparing the velocity patterns with the fish trajectories, the attractiveness of different configurations of fish shelters could be analyzed. The first tests reveal that a very basic shelter configuration, with low water exchange between shelter and channel, is not interesting for fish. When forcing a water exchange by introducing a deviation groyne into the shelter with the aim to force the water exchange, the frequentation rate can be increased significantly. The fish can easily detect the refuge by the exchange flux when searching its way upstream. The shelter attractiveness was optimized by testing different groyne orientations, in order to create an expanded velocity field close to the exit and entrance sections. Important is a high velocity field leaving the refuge at its lower end but also a backwater zone near the groyne. The high velocity field attracts the fish and the close backwater zone allows the fish to enter the shelter. For the best configuration, more than 80% of the fish found the shelter by swimming mainly from downstream, during the next 20 minutes after the beginning of hydropeaking.

Keywords: Hydropeaking, Fish shelter, Groyne, Juvenile wild brown trout, Swimming trajectories, UVP, Velocity fields.

1 INTRODUCTION

1.1 Literature review

The electricity production cycles of Storage hydropower plants are responsible for the hydropeaking phenomena, characterized by rapid and frequent changes in turbinated flow discharge into the river. Ecological value of river reaches affected by hydropeaking is therefore significantly reduced. The Fischnetz study (2004) reveals that the brown trout caught in Swiss rivers has diminished by approx. 60% since 1980. Hydropeaking is mentioned to be partly responsible for this decrease.

When hydropeaking occurs fish are weakened by the increase of flow velocities, which can go

up to causing mortality amongst population along with invertebrates (Jungwirth et al. 2003). When turbines are closed, rapid lowering of the water surface level brings the fish to be trapped on the substrate of the high water channel (Baumann and Klaus 2003). Also, degradation of natural habitats has been made evident (Valentin et al. 1996, Ovidio et al. 2006, Gouraud et al. 2008), considering a bedload regime being likewise highly altered (Baumann et Klaus 2003, Eberstaller et Pinka 2001).

Technical measures have been studied in order to reduce the effects of hydropeaking (Meile 2008, Heller et al. 2007). Fish shelters are commonly proposed when it comes to preventing the effect of high velocities. In this sense Valentin et al. (1996) demonstrated the relevance of the later-

al bank refuge. These can protect fish and other organisms from rapid hydraulic parameters variations.

1.2 Goal of the research

The goal of this research work is to provide scientific knowledge and design criteria to built fish shelters along rivers. The strategic approach is based on an experimental phase in laboratory and a validation phase in a river. This report gives an account of the laboratory experiments conducted with fish swimming in a channel with a lateral shelter. The flow velocities in the channel are similar to the real conditions. The purpose is to place fish under hydropeaking conditions in the channel, to follow the swimming trajectories towards the shelter and to measure the flow velocities across these trajectories. The data analysis allows defining the preferred hydraulic conditions for fish. These conditions are then optimised to maximise the shelter attractiveness. For this purpose, several shelters configurations are first simulated numerically in 2D and the most significant are then tested experimentally.

2 METHODOLOGY AND INVESTIGATIONS

2.1 Experimental conditions for tests with fish

In order to find optimal shelter configurations, fish have been exposed to hydropeaking conditions in a channel outfitted with a lateral shelter. An eco-hydraulic channel was built for this purpose in the former powerhouse of Maigrage dam in Fribourg (Switzerland), thus having direct access to an inlet supplying the system with permanent fresh river water (Fig. 1) and enabling to control light intensity. The effective length of the channel is 12 m with a width of 1.2 m. The shelter of 2 m length and 1.2 m width is located on the right bank.

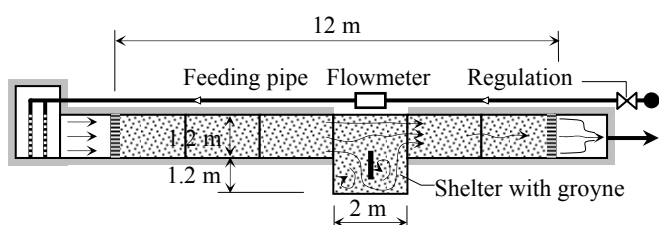

Figure 1: Eco-hydraulic test flume in the former powerhouse of Maigrage dam, top view.

As in case of danger the fish generally lay near the bed at the toe of embankment, the channel reproduces solely this part of the river, which is much larger in reality. The channel bed is made

out of coarse gravel, plugged with mortar and painted white to enhance fish visibility. The refuge is covered with pebbles and stones with the purpose of simulating the juvenile trout's favorite substrate (Vismara et al. 2001, Valentin et al. 1996). Hydropeaking occurs when opening the regulation gate. Flow and water temperature are then continuously measured.

The channel is designed to be able to simulate average favourable or disfavoured velocities regarding the preferred habitat plots (Vismara et al. 2001) of the brown trout (*Salmo trutta fario*) at a juvenile stage (0+ and 1+). Maximum channel inflow is 220 l/s, thus average velocities go from 0.2 m/s for the base flow condition of 20 l/s to 1 m/s when hydropeaking occurs. Water depth varies from 0.10 m to 0.20 m (Fig. 2).

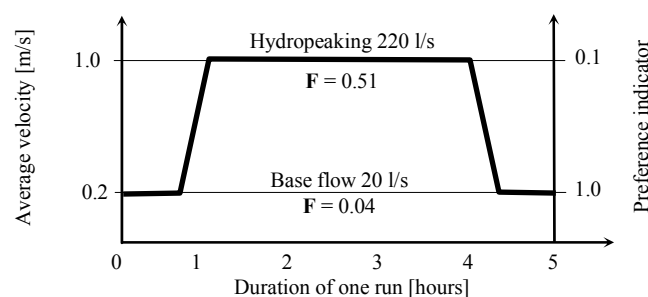

Figure 2: Channel hydraulic parameters related to preference plots for the fario trout at a juvenile stage, according to Vismara et al. 2001 (1.0 = best preference).

Tests were performed with wild brown trout (*Salmo trutta fario*) at its juvenile stage (0+ and 1+) (Murchie et al 2008, Gouraud 2008, Flodmark 2006, Valentin 1995, Scruton 2003), captured by electrofishing in a river of the Swiss plateau. Tests were arranged to happen in spring and autumn, when the water temperature lies between 6°C and 16°C (Fig. 3) (Küttel et al. 2002, Jungwirth et al. 2003).

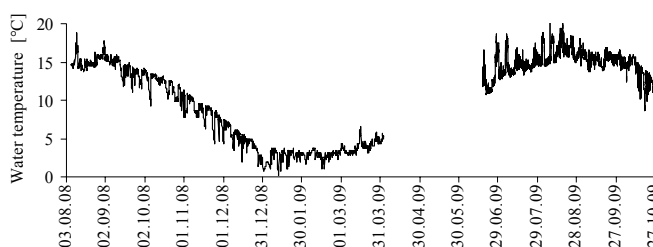

Figure 3: Water temperature recording, in the inlet river.

Before any test a 20 l/s uniform flow is established in the channel. Then the fish are introduced in the channel entrance in a temporarily separated compartment for getting used to the water conditions. They are then released and the flow in the channel is increased from 20 to 220 l/s in a few

minutes time interval, and maintained to that value for 3 hours. Position of individuals is visually taken down every 20 minutes during the hydro-peaking time interval.

Also tracking is registered by a camera placed perpendicularly above the refuge. Videos recordings are analyzed image after image. Each refuge configuration is tested 3 times with two groups of 10 fishes and one of 20 fishes.

2.2 Preliminary analysis with 2D simulations

A preliminary analysis was made using a 2D numerical simulation model as dealing with low water-depth flows. BASEMENT « BASic Environment for simulation of natural flow and hazard simulation » (Fäh et al. 2008) was used to that purpose. Assuming a static pressure distribution and neglecting vertical flow components, the 2D shallow water equations are applicable. This set of equations provides accurate results for the behavior of water level and velocity in a horizontal plane. Turbulence effects cannot be resolved any more but are accounted for by an artificial friction factor in the closure condition, which establishes a relation between flow velocity and shear stress. The model considers alternatives by solving unsteady flow equations at an average depth using the finite volumes numerical pattern. The SMS program « Surface Water Modeling System » was used to build the grid, to pre- and post-process the data and to illustrate the results. The grid covers the entire experimental installation with rectangular cells along the channel, to reduce the computation time, and triangular cells within the refuge to ensure the numerical stability (Fig. 4)

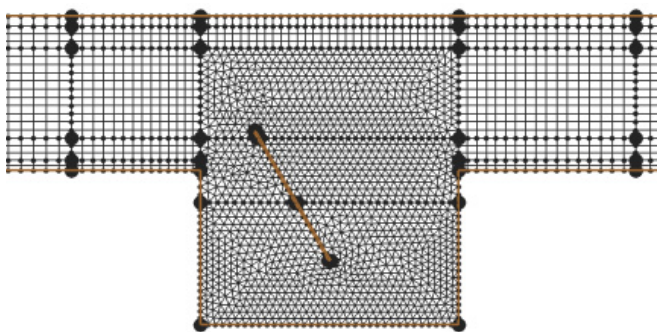

Figure 4: Cells network generated by SMS for the Basement 2D simulations, focus on the refuge sector.

At first, BASEMENT was used to define the adequate geometry of the experimental flume. It was then used to generate successive shelter configurations and to compute the diverted discharge through the shelter. The validity of 2D simulations is however limited as the velocity is not correctly defined near the bottom, exactly where the fish

are swimming (Scruton et al. 2003). For this reason, velocity measurements are required.

2.3 Velocity measurements with UVP

Local velocity distribution data are required to compare different shelter configurations and to understand which hydraulics conditions are preferred by fish while swimming. Velocity measurements had to be undertaken a posteriori, thus considering the severe constraints imposed by the live fish behavior investigations. Horizontal velocity component was measured by means of an Ultrasonic Doppler Velocity Profiler (Metflow SA, UVP Duo). Explored surfaces are the vertical interface between the refuge and the channel, as well as the horizontal plane sector close to the bottom covering the fish's preferential paths (Fig. 5). Transversal distribution was measured in a similar way throughout the channel sections upstream and downstream from the refuge.

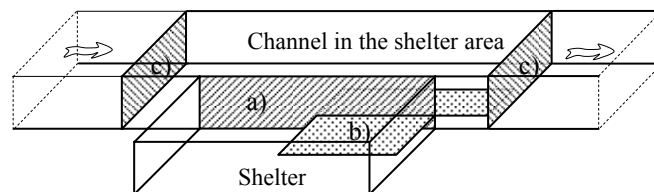

Figure 5: Velocity field measurement planes, a) Vertical interface between channel and shelter, b) Horizontal plane sector defined by the fish's preferential paths, c) Channel transversal sections upstream and downstream from the refuge.

Vertical velocity profiles were measured simultaneously by six 1 MHz UVP transducers. The probes were fixed on one line and spaced by 12 to 18 cm, depending on the amplitude and gradient of the local velocities. With this arrangement, the interface section is covered by 12 velocity profiles. Submerged under the free surface, each transducer is fixed on a support in order to ensure an inclination angle of 20° from vertical (Fig 6). The ultrasonic signal crosses the interface section at a distance of 5 cm from the bottom of the channel. The vertical velocity profiles are used within the 0 to 10 cm band corresponding to the fish swimming zone. The single horizontal component of the velocity vector was measured considering shallow flow conditions.

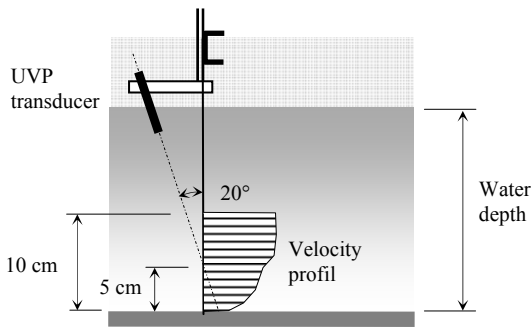

Figure 6: Position of a UVP transducer in the vertical plan.

In order to get more accurate data on the path adopted by the fishes entering the shelter, the horizontal velocity field was measured in the neighbourhood of its exit corner (Fig. 7). These measures were conducted with UVP Flow-mapping. In this case, 6 UVP transducers were arranged 3 by 3 in a horizontal plane, located 5 cm over the bottom, allowing the signals to intersect orthogonally. At each intersection, the 2 velocities components are measured. Velocity fields were interpolated and plotted using Surfer 8. Control and validation measurements were locally performed with a micro current-meter.

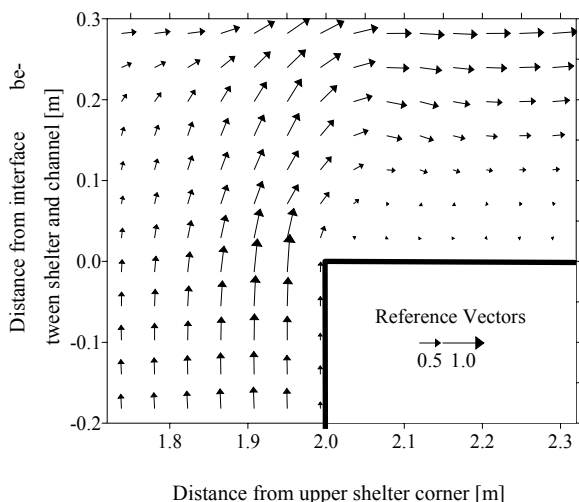

Figure 7: Velocity field on the downstream corner of shelter, measured by UVP flow mapping for configuration C1.

3 OBSERVATIONS AND RESULTS

3.1 Importance of water exchange between channel and shelter

The first investigation tests concern the basic refuge configuration C0. Experiment shows that attractiveness of the cavity, built as a simple bank indentation, is very weak for the fish. Counting of individuals actually shows an average frequentation of the refuge of 33%, as well as a strong inconsistency during the 3 hours of the investigation period. Lack of interest can be linked to the low

flux exchange between the refuge and the main channel. Transit flow in the refuge can be computed by integrating the simulated velocities through the vertical plane separating the refuge from the main channel. It is equal to 3.5 l/s for the C0 configuration, which corresponds to 1.6% of the total hydropeaking flow only.

A vertical wall was inserted in the shelter over the whole water depth intersecting the center of the vertical interface between the channel and the shelter. The aim of this panel is to increase water circulation in the refuge and the exchange with the channel (Fig. 8).

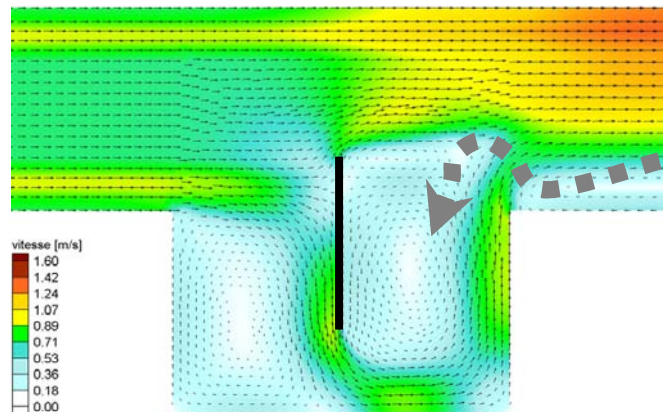

Figure 8: Configuration C1, velocity field simulated with Basement-2D. Fish trajectories at the entry in the shelter (grey arrow).

The outer edge of the wall protrudes the channel section at a 30 cm distance. Inner edge is 50 cm from the refuge sidewall. These values were maintained throughout all the tested configurations by changing the angle of the wall with the flow direction (Fig. 11). Indeed, investigation of the C1 configuration resulted in a 75% average frequentation of the shelter with a diverted discharge of 58 l/s. Video recordings clearly reveal a preferential path (Fig. 8) regarding the fish entering the shelter from downstream, during hydropeaking. Indeed, they find a path upward the channel along the right sidewall taking advantage of relatively low velocities, leading to the downstream corner of the refuge. Individuals recover a few seconds as they reach a low velocity area before crossing a higher velocity field in order to reach the shelter behind the derivation wall. They come temporary to a standstill before entering deeper into the refuge.

A detailed distribution of fish entries through the interface section was recorded in order to build up a customized base for other configurations analyses and comparisons. Figure 9 shows this distribution stacked with UVP average velocity distribution.

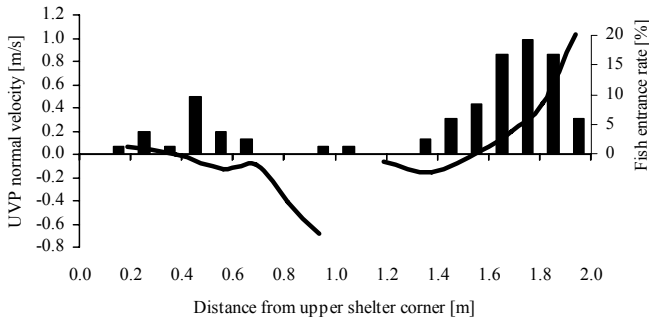

Figure 9: Configuration C1, fish entrance rate (bars) stacked with UVP velocity (line) and referred to distance from upper shelter corner.

3.2 Comparison of measured and the simulated velocities

Regarding the flow velocity distribution through the interface section, the representativity of the 2D data averaged over the whole water depth has been scrutinized knowing that the fishes are moving next to the bottom (Scruton et al., 2003). The UVP measures analysis shown that within the most contributing sectors, the horizontal normal velocity components are weakly varying over the vertical profiles, except near the bottom where a strong decrease can be noticed for a depth of about 3cm. For the same purpose, the normal velocity components over the water depth simulated by BASEMENT where compared to the UVP and to the micro current-meter measures (Fig. 10). If overall all the curves have the same shape, the extreme UVP values stand out, especially along the sidewalls at the centre and the exit of the shelter. These observations confirm that the 2D simulation with BASEMENT is interesting for the global analysis of configurations, provided that local verifications are done.

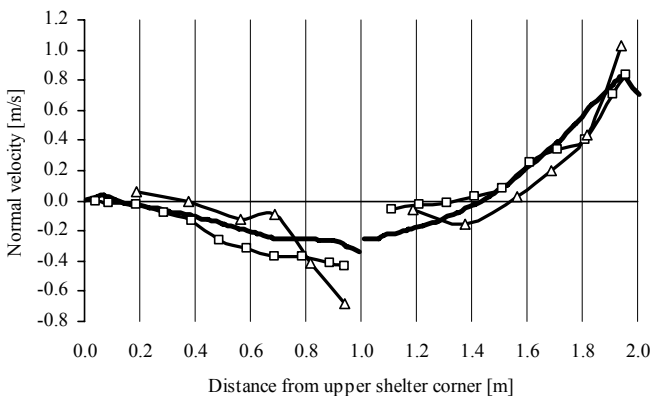

Figure 10: Normal component velocity profiles across the interface between shelter and channel, for configuration C1, — computed with Basement 2D, —□— measured with micro current-meter, —△— measured with UVP.

The observations showed that hydraulic conditions with a backwater downstream of the panel and a water exchange between refuge and main

channel of about 20 to 25% are most optimal in view of fish attractiveness. The conditions upstream of the wall should show a similar behavior but their influence is less important since fish prefer entering the refuge from downstream.

3.3 Comparison between various configurations

Based on observations and obtained results, the C1 configuration (Fig. 8) has been referred as the starting point for enquiries and analysis of more attractive configurations. Keeping constant the impounded surface of the C1 panel on the channel, different positions were tested by varying the wall's angle of $\pm 30^\circ$ around the perpendicular position of C1 to the axis of the channel. 3 fixed points were chosen: 2 at the C1 panel's extremities (Fig. 11, points A and V), and one on the interface's line (Point X). Subsequently, 3 configurations were tested for each fixed point: 2 simple configurations and one constituted of two walls. The aim of the procedure was to examine the variability of the diverted discharge and the velocity profile characteristics through the interface section. Overall, 12 configurations were tested (Fig. 12).

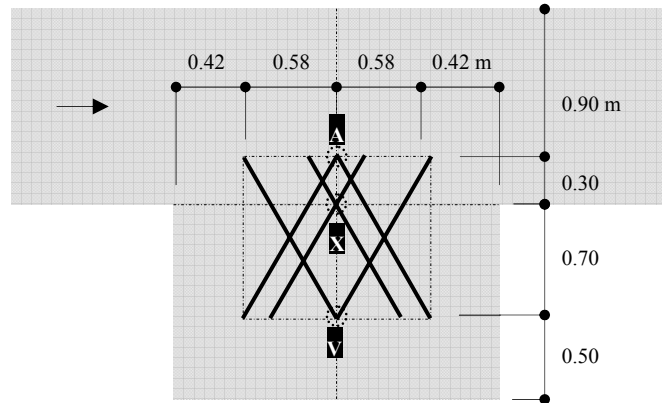

Figure 11: Geometry of fish shelter and wall positions, characterized with fix points A, X, V.

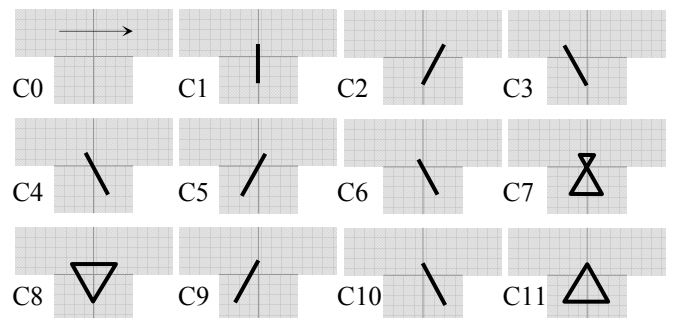

Figure 12: Position and inclination of the vertical wall for configuration C0 to C11.

Globally, each configuration is represented by the derived discharge and the average frequentation rate of the shelter (Fig. 13). The C8 configura-

ration gives the maximal frequentation rate (87%) for a diverted discharge of 47 l/s.

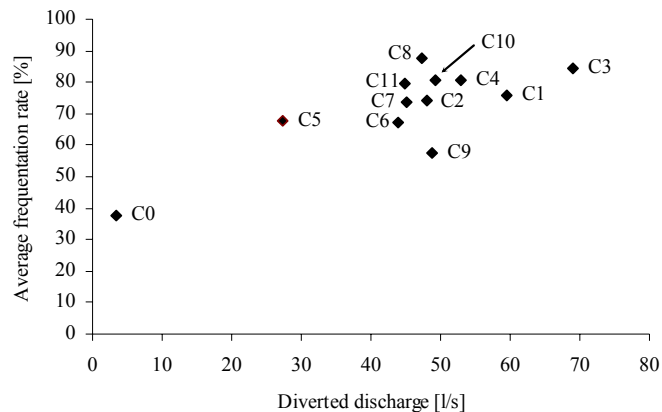

Figure 13: Average frequentation rate of the shelter by fishes, reported to the diverted discharge to the shelter, for each configuration.

For this reason, the C8 configuration is presented as a comparative example to the C1 configuration in this paper. Characterised by a deflecting groyne shaped like an equilateral triangle, it is a combination of the C2 and C3 configurations. With regard to the BASEMENT 2D results, the velocity variability is almost linear along the interface line. The video recordings showed that almost all the fishes entered the shelter from downstream (Fig. 14).

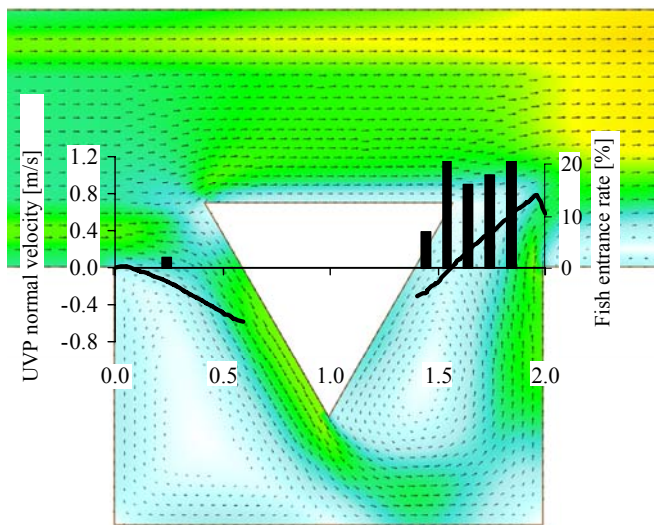

Figure 14: Configuration C8, velocity field simulated with Basement-2D. Fish entrance rate (bars) stacked with UVP velocity measurements (line) and referred with distance from upper shelter corner.

Regarding the distribution of the fish's entry within the shelter, most of them enter by the downstream end corner of the shelter (Fig. 15). As for this specific configuration, the fishes enter the shelter travelling up the current from the channel exits; it reveals the importance of the appealing current generated by the exiting flux from the shelter. However, it must be noticed that for each configuration, a different entry distribution applies

for the upstream and downstream end of the wall. Regarding fish's entry in the shelter from upstream C10 configuration revealed as the best (Fig. 15) having also a very high average frequentation rate (Fig. 13).

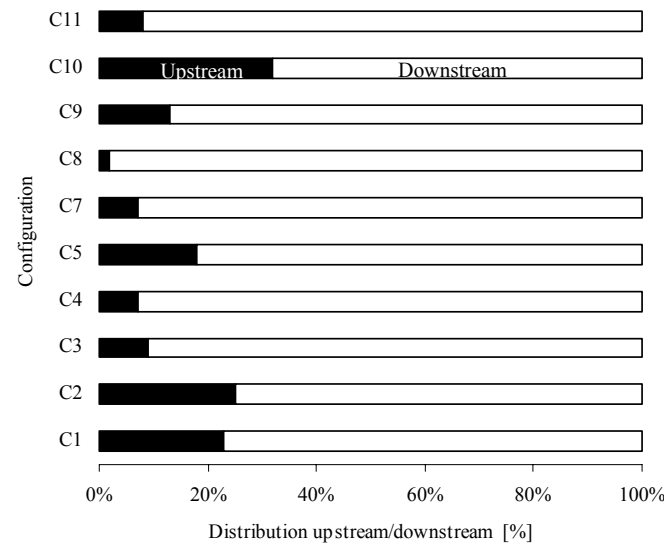

Figure 15: Distribution upstream/downstream of fish entry in the shelter, for each configuration

4 CONCLUSION

This research study aims to find optimum fish shelter configurations in river banks which can improve survival conditions during hydropeaking. Juvenile brown trout are used as reference in fresh river water fed channel. At present stage it can be said that a very basic refuge configuration, with low water exchange between shelter and channel, is not interesting for fish. When forcing a water exchange by introducing a deviation panel into the shelter, its frequentation can be increased significantly. The fish can easily detect the refuge by the exchange flux when searching its way upstream. The refuge attractiveness can be optimized by testing different wall orientations which create an expanded velocity field close to the exit and the entrance. Important is a high velocity field leaving the refuge at his lower end but also a backwater zone near the panel. The high velocity field attracts the fish and the close backwater zone allows him to enter the refuge.

The test performed until now reveal that a fish refuge with appropriate flux exchange with the channel can be found by fishes even under severe hydropeaking condition. The configuration will be further improved in order to have also a good attractiveness for fishes traveling from upstream. An example towards this goal is C10 configuration. For prototype configurations it is important also to consider the sedimentation problem

by fine sediments. Of course the refuge geometry would have to be smooth with a groyne reproducing the effect of the panel in the laboratory. Microhabitat potential would have to be studied also in detail.

ACKNOWLEDGMENTS

This study is conducted in collaboration with Dr Armin Peter from the Swiss Federal Institute of Aquatic Science and Technology (EAWAG), for the fish's behavior questions.

The interdisciplinary research is supported in the framework of "The integrated management of river systems" by the Swiss Federal Office for Environment and the Swiss Innovation Promotion Agency, KTI-CTI contract No 9676.1.

REFERENCES

- Baumann P., Klaus I 2003. Conséquences écologiques des éclusées, Etude bibliographique, Informations concernant la pêche n° 75, OFEV, Berne.
- Eberstaller J., Pinka P. 2001. Trübung und Schwall Alpenrhein - Einfluss auf Substrat, Benthos, Fische, Teilbericht Fischökologie, Abteilung für Hydrobiologie, Fischereiwirtschaft und Aquakultur, Internationale Regierungskommission Alpenrhein Projektgruppe Gewässer- und Fischökologie, Wien Mai 2001.
- Fäh R., Rousselot P., Vetsch D., Volz C., Farshi D. 2008. Reference manual of BASEMENT, version 1.5, ETH Zürich, VAW.
- Fischnetz 2004. Sur la trace du déclin piscicole. Rapport final. EAWAG/OFEFP, Dübendorf, Bern.
- Flodmark L. E. W., Forseth T., L'Abe'e-Lund J. H., Vøllestad L. A. 2006. Behaviour and growth of juvenile brown trout exposed to fluctuating flow, *Ecology of Freshwater Fish* 2006: 15: 57–65.
- Gouraud V., Capra H., Sabaton C., Tissot L., Lim P., Vandewalle F., Fahrner G., Souchon Y. 2008. Long-term simulations of the dynamics of trout populations on river reaches bypassed by hydroelectric installations – Analysis of the impact of different hydrological scenarios, *River. Res. Applic.* (2008)
- Heller Ph., Pellaud M., Bollaert E., Schleiss A., Schlaepfer R. River rehabilitation through a multi-purpose reservoir. Proceedings of the 32nd Congress of IAHR, Special session 06 (SS06-07-0), Venice, Italy, 1.-6.July 2007, CD.Rom, 2007
- Hilden M. 2003. Extensions of shallow water equations – Erweiterungen der Flachwassergleichungen, Dissertation. Universität Kaiserslautern.
- Küttel S., Peter A., Wüest A. 2002. Rhône Revitalisierung, Temperaturpräferenzen und –limiten von Fischarten Schweizerischer Fließgewässer, Publikation Nr. 1.
- Jungwirth M., Haidvogel G., Moog O., Muhar S., Schmutz S. 2003. Angewandte Fischökologie an Fließgewässern, UTB Verlag Wien.
- Meile T. 2008. Influence of macro-roughness of walls on steady and unsteady flow in a channel. Communication 36 of Laboratory of Hydraulic Constructions, Ed. A. Schleiss, Ecole polytechnique fédérale de Lausanne, 2008, ISSN 1661-1179.
- Murchie K.J., Hair K.P.E., Pullen C.E., Redpath T.D., Stephens H.R. Cooke S.J. 2008. Fish response to modified flow regimes in regulated rivers, *Research methods, effects and opportunities*, *River Research and Applications* 24: 197 - 217.
- Ovidio M., Capra H., Philippart J.-C. 2008. Regulated discharge produces substantial demographic changes on four typical fish species of a small salmonid stream, *Hydrobiologie* (2008) 609:59-70.
- Pedersen L.F., Koed A., Malte H. 2008. Swimming performance of wild and F1-hatchery-reared Atlantic Salmon (*Salmo salar*) and brown trout (*Salmo trutta*) smolts, *Ecology of Freshwater Fish* 2008: 17, p. 425 – 431.
- Ribi J.-M., Steffen K., Boillat J.-L., Peter A., Schleiss A.J. 2009. Influence of geometry of shelters in river banks on their attractiveness for fishes during hydropeaking. Proceedings of the 33rd Congress of IAHR, Vancouver, Canada, August 9-14 2009, ISBN: 978-94-90365-01-1
- Scruton D. A., Ollerhead L.M. N., Clarke D., Pennell C., Alfredsen K., Harby A., Kelley D. 2003. The behavioural response of juvenile atlantic salmon (*Salmo salar*) and brook trout (*Salvenius fontinalis*) to experimental hydropeaking on a Newfoundland (Canada) river, *River Res. Applic.* 19: 577–587 (2003).
- Steffen K. 2009. Etude de refuges à poissons aménagés dans les berges de rivières soumises aux éclusées. Master thesis at the Laboratory of Hydraulic Constructions (LCH), Ecole polytechnique fédérale de Lausanne (EPFL), Switzerland, January 2009.
- Valentin S. 1996. Modeling temporal variations of physical habitat for brown trout (*Salmo trutta*) in hydropeaking conditions, regulated rivers; *Research & Management*, VOL. 12, 317-330 (1996).
- Valentin S. 1995. Variabilité artificielle des conditions d'habitat et conséquences sur les peuplements aquatiques: effets écologiques des éclusées hydroélectriques en rivière, Etude de cas et approches expérimentales, thèse, Université de Claude Bernard – Lyon.
- Vismara A., Azzellino R., Bosi R., Crosa G., Gentili G. 2001. Habitat suitability curves for brown trout (*Salmo trutta fario* L.) in the river Adda, northern Italy: Comparing univariate and multivariate approaches, *Regul. Rivers: Res. Mgmt.* 17: 37–50 (2001).