

## SIMULATION OF TRANSIENT PHENOMENA IN FRANCIS TURBINE POWER PLANTS: HYDROELECTRIC INTERACTION

**Christophe NICOLET**  
**Prof. François AVELLAN**

*EPFL / Laboratory for Hydraulic Machines,  
Lausanne, Switzerland*

**Philippe ALLENBACH**  
**Dr. Alain SAPIN**

*EPFL / Electrical Machines Laboratory,  
Lausanne, Switzerland*

**Prof. J.-Jacques SIMOND**

**Dr. Sonia KVICINSKY**

*Power Engineering*

**Marcus CRAHAN**

*Costa Mesa, California*

### ABSTRACT

Models of hydraulic components based on impedance method have been implemented in a software called "SIMSEN". This tool allows the simultaneous solution of the electrical, hydraulic, mechanic and control equations ensuring a proper interaction between the four parts of a system. In this paper the interaction between hydraulic and electric part of 2 Francis turbines power plant is investigated by comparing the simulation results obtained with and without coupling hydraulic and electric phenomena. Using hydraulic, electric and hydroelectric simulation models, total load rejection, earth fault, out of phase synchronization and load variation have been investigated. Hydroelectric simulations offer the advantage to enable to study the coupling of hydraulic and electric parts and to optimize regulators parameters in interconnected mode.

### NOMENCLATURE

Term	Symbol	Definition	Term	Symbol	Definition
Piezometric head	H	$H = z + p/(\rho g)$ [m]	Hydraulic resistance	R	$R = R' \cdot dx$ [s/m <sup>2</sup> ]
Flow rate	Q	[m <sup>3</sup> /s]	Hydraulic inductance	L	$L = L' \cdot dx$ [s <sup>2</sup> /m <sup>2</sup> ]
Wave speed	a	[m/s]	Hydraulic capacitance	C	$C = C' \cdot dx$ [m <sup>2</sup> ]
Cross section area	A	[m <sup>2</sup> ]	Rated head	h	$h = H/H_R$
Friction factor	$\lambda$	[-]	Rated torque	$\beta$	$\beta = T/T_R$ [-]
Singular losses coefficient	K	[-]	Static turbine characteristic	$\theta$	$\theta = \tan^{-1}(u/\alpha)$
Electrical resistance	R <sub>e</sub>	[ohm]	Rated flow	u	$u = Q/Q_R$ [-]
Electrical inductance	L <sub>e</sub>	[H]	Rated rotating speed	$\alpha$	$\alpha = \omega/\omega_R$ [-]
Electrical capacitance	C <sub>e</sub>	[F]	Density	$\rho$	[Kg/m <sup>3</sup> ]
Rotating speed	$\omega$	[rad/s]	Mechanical inertia	I	[Kg·m <sup>2</sup> ]
Torque	T	[Nm]	Guide vane opening degree	y	[-]

## INTRODUCTION

The operation of an hydroelectric power plant is subject to several transient phenomenon due to group start-up and shut-down, modification of operating point, earth fault, out of phase synchronization during start-up, emergency stop and so on. In order to ensure the safety of the power plant and to optimize operation parameters, a simulation model of the power plant is requested to investigate all the worst cases. The simulation of the dynamic behavior is usually performed separately for the hydraulic and electric part of the power plant allowing to determine the set of parameters related to the security of each part. Afterwards control command parameters have to be calculated considering the operation stability. However, it requires a full model of the power plant taking into account the hydraulic, electric, mechanical and control device components.

The EPFL Laboratory for Electrical Machines –LME– has developed a software called SIMSEN (Ref. 7, Ref. 8) for the simulation of electrical power networks systems in transient or steady state modes and adjustable speed drive systems. This software is based on a modular structure which enables to consider systems with arbitrary topology. It is composed of units, each representing a specific element in the network: electrical machine, mechanical system taking into account mechanical masses connected with damping and springs, transformers, voltage supplies, transmission lines, loads, static converters, controllers, semi-conductor. Each unit includes a set of differential equations based on the network element model. An original algorithm has been developed to generate a global set of differential equations solved by fourth order Runge-Kutta procedure. The variable time-step used for the integration of the governing equations allows to detect the exact sequence of events such as on-off switching of semi-conductors or circuit-breakers phase on-off switching.

To be able to study the dynamic behavior of a whole hydroelectric power plant including electrical, hydraulic and control components, a hydraulic extension has been developed and implemented in SIMSEN (Ref. 5 and Ref. 6). This development is the result of the collaboration between the LME and the EPFL Laboratory for Hydraulic Machines. The extension includes the models of pipe, valve, surge tank and Francis turbine. To fit to the formalism of this software the impedance method (Ref. 1, Ref. 2 and Ref. 9) has naturally been chosen for the modeling of the hydraulic components. Thus, the corresponding governing equations can be implemented easily and the hydraulic extension benefits from the arbitrary topology feature allowing to model complex piping systems. Another advantage is the possibility to study hydraulic installations on their own or with the inclusion of both control devices and electrical units. The modeling of the hydraulic components is presented in Table 1.

This paper deals with the simulation of the transient behavior of a 2 Francis turbines power plant using 3 models (hydraulic, electric and hydroelectric). The hydroelectric model is the coupling of the hydraulic and the electric models. Four cases have been simulated: total load rejection, earth fault, out of phase synchronization and load variation. For each case, one performed comparison between results obtained with the hydraulic, electric and hydroelectric models.

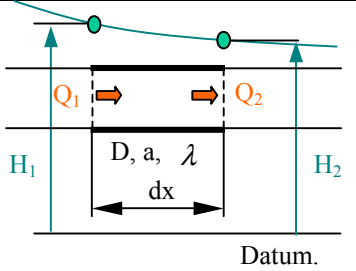
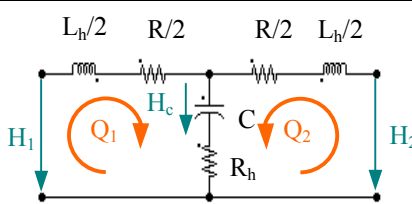
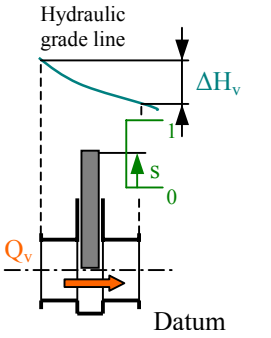
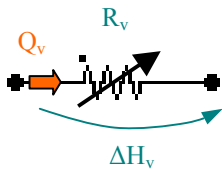
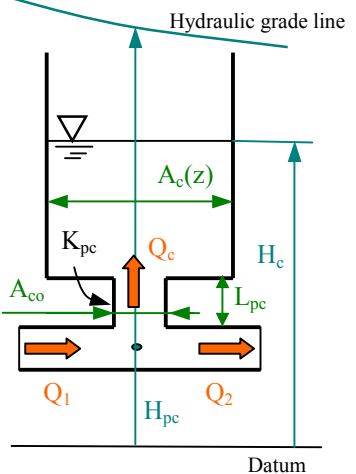
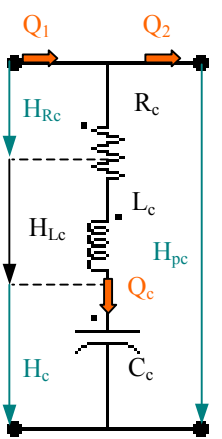
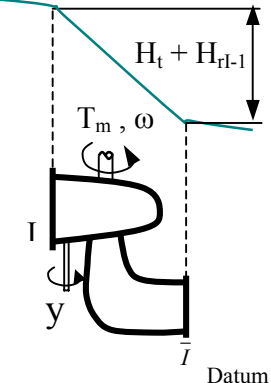
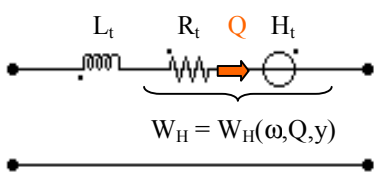
Component	Electrical equivalent	Equation set
 <p>Datum.</p>		$\frac{dx \cdot a^2}{gA} \frac{dH_c}{dt} = C \frac{dH_c}{dt} = Q_1 - Q_2$ $\Delta H_R = \frac{\lambda dx  Q_1 }{2DgA^2} Q_1 = RQ_1$ $\Delta H_L = \frac{dx}{gA} \frac{dQ_2}{dt} = L \frac{dQ_2}{dt}$
 <p>Datum</p>		$\Delta H_v = \frac{ Q_v }{2g(C_d(s)A_G(s))^2} Q_v$ <p style="text-align: center;"><math>R_v</math></p>
 <p>Datum</p>		$(H_{pc} - H_c) = \frac{K_{pc}  Q_c }{2gA_{co}^2} Q_c$ <p style="text-align: center;"><math>R_c</math></p> $A_c(z) \frac{dH_c}{dt} = Q_c$ <p style="text-align: center;"><math>C_c</math></p> $L_c = \frac{L_{pc}}{gA_{co}}$
 <p>Datum</p>		$W_B(\theta) = \frac{\beta}{\alpha^2 + v^2}$ $W_H(\theta) = \frac{h}{\alpha^2 + v^2}$ $\theta = \tan^{-1}(v/\alpha)$ $L_t = \int_{\bar{i}}^{\bar{i}} \frac{1}{gA(x)} dx$

--	--	--

**Table 1** Modeling of the hydraulic components using impedance method.

**CASE STUDY**

The system that has been investigated comprises a tank, a gallery, a surge tank, 2 Francis turbines of 86 MW and 2 generators connected to a 205 kV network (Fig. 1). The data corresponding to this example are presented in Table 2 and the characteristic curves of the turbines are presented in Fig. 2 with Sutter representation (Ref. 4). The transient behavior of the power plant is simulated using the hydraulic model, the electric model and a hydroelectric model in which both models are integrated.

Gallery	Surge Tank	Pipe	Turbines	Generators
$L = 4000 \text{ m}$	$A(z < 77) = 700 \text{ m}^2$	$L = 125 \text{ m}$	$H_{tR} = 82 \text{ m}$	$I_{t+g} = 1.767e6 \text{ Kgm}^2$
$D = 10 \text{ m}$	$A(77 < z < 87) =$	$D = 5.5 \text{ m}$	$n_R = 200 \text{ rpm}$	$S_n = 98 \text{ MVA}$
$\lambda = 0.03$	$400 \text{ m}^2$	$\lambda = 0.02$	$Q_{tR} = 114 \text{ m}^3/\text{s}$	$U_n = 17.5 \text{ kV}$
$a = 1000 \text{ m/s}$	$A(z > 87) = 700 \text{ m}^2$	$a = 1250 \text{ m/s}$	$T_{tR} = 4.11e6 \text{ Nm}$	

Table 2 Characteristics of the power plant.

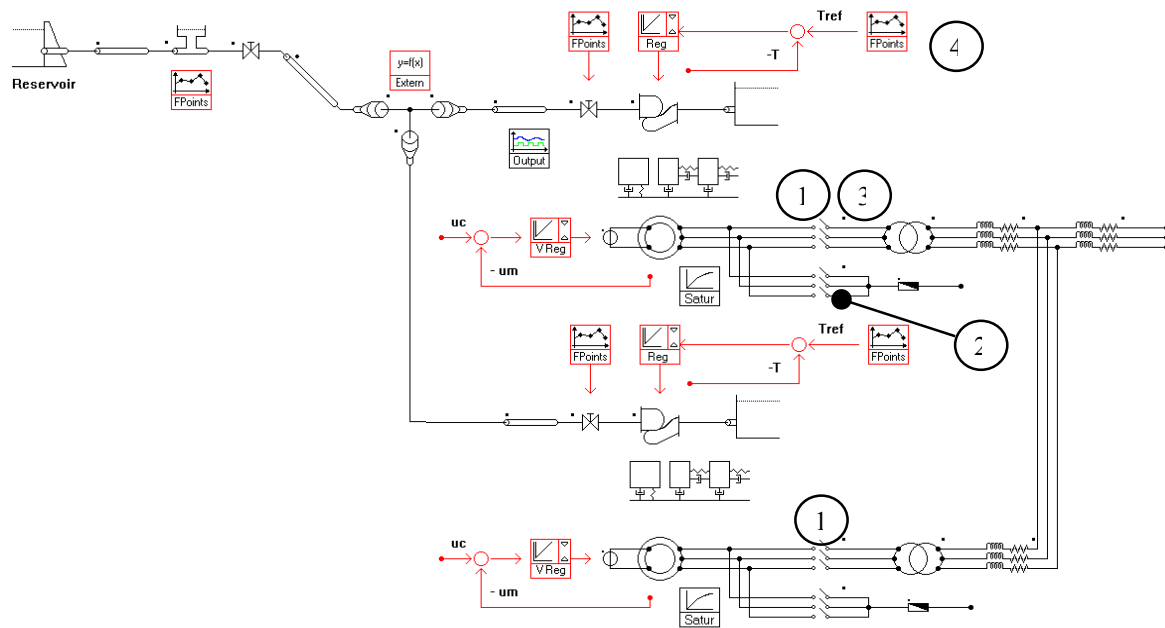

**Fig. 1** Modeling of the power plant with SIMSEN including two Francis turbines coupled to generators.

Using the 3 simulation models established with SIMSEN, four transient cases have been investigated allowing for a comparison between electric/hydraulic and hydroelectric simulation results under the following conditions:

- total load rejection (1) (hydraulic and hydroelectric models)
- earth fault (2) (electric and hydroelectric models)
- out of phase synchronization (3) (hydroelectric model)
- load rejection and acceptance (4) (hydroelectric model)

The trijunction, which distributes the flow rate to the turbines, has been modeled by three singular losses parameterized using a coefficient function of the the flow rate repartition between the three branches. The losses coefficients are taken from Ref. 3.

PID controllers have been used for:

- rotational speed regulation acting on the field voltage of the generators
- rotational speed regulation acting on the guide vane opening degree of Francis turbine in isolated production mode
- power regulation acting on the guide vane opening degree of Francis turbine in interconnected production mode

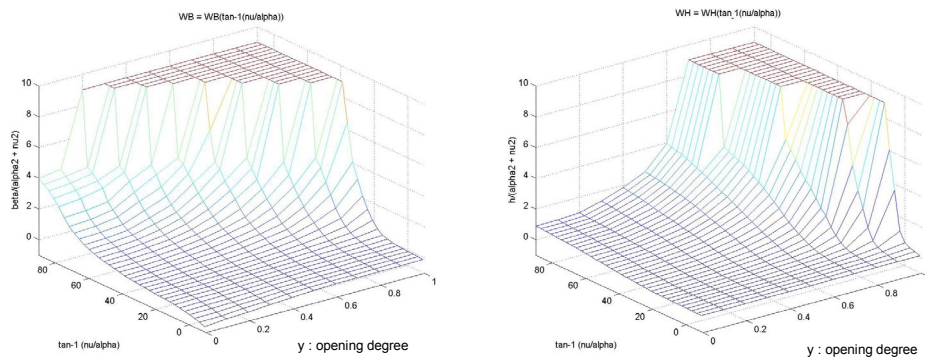

**Fig. 2** Characteristics  $W_B$  and  $W_H$  of the turbines.

### Total load rejection

The first investigation concerned total load rejection where the circuit-breaker between the

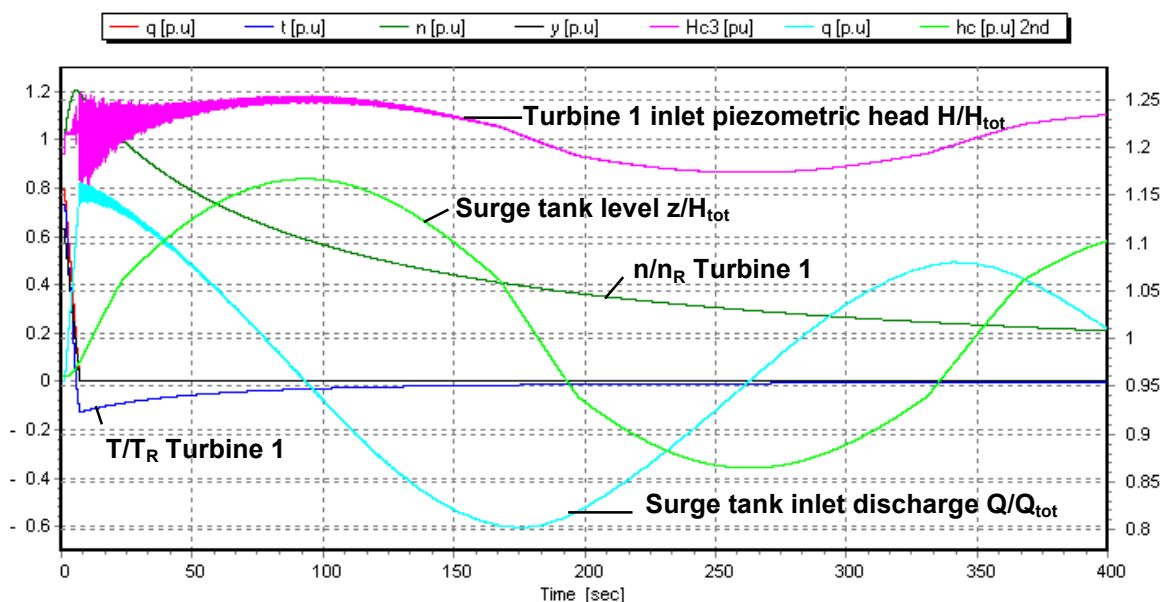

transformer and the generator is switched off. Simultaneously, the distributor of the two Francis turbines are closed in 7 seconds linearly. The evolution of the main variables during and after the total load rejection is presented in Fig. 3 and Fig. 4.

Fig. 3 Evolution of the main variables of the power plant during total load rejection for the two turbines.

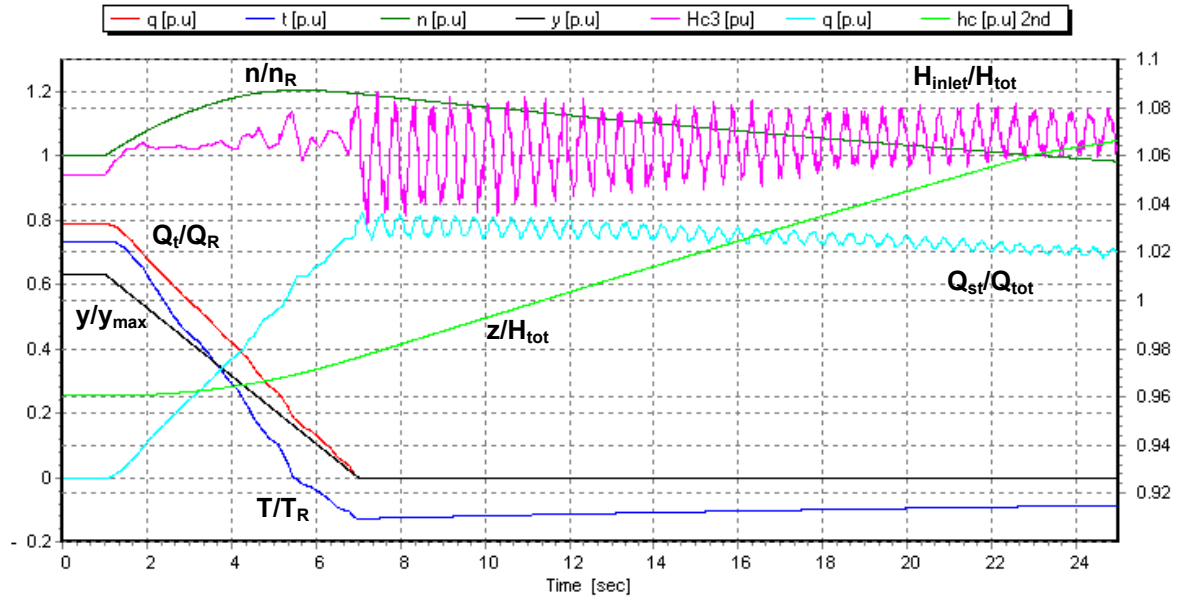
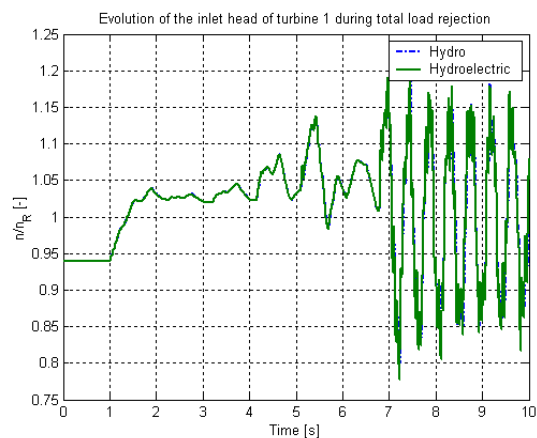
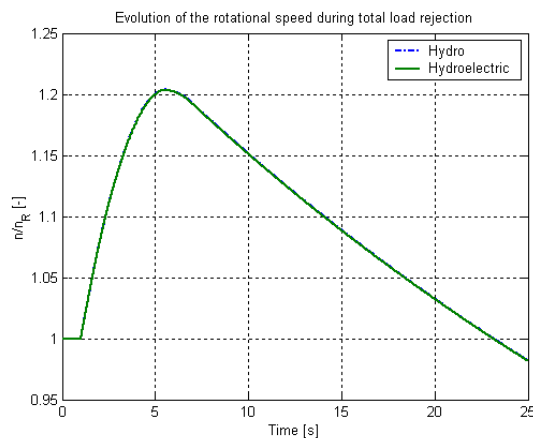

Fig. 4 Evolution of the turbine 1 variables during total load rejection

At the outset, the electromagnetic torque of the generators drops to zero instantaneously, as a result the rotational speed of the groups increases. The closure of the distributor reduces the hydraulic torque quickly limiting the rotational speed. The distributor closure induces a Waterhammer effect in the adduction part of the power plant and a mass oscillation between the reservoir and the surge tank. Moreover, the effect of non-uniform surge tank cross-section is properly taken into account. This simulation demonstrates the capability of hydraulic modeling to reproduce mass oscillation and Waterhammer effects. The same simulation has been performed considering the hydraulic model alone and assuming that the electromagnetic torque drops instantaneously to zero at  $t = 1$ s. The comparison between the hydraulic and hydroelectric simulation results are shown in Fig. 5. The two most important parameters affected by this transient disturbance are the maximum speed and the maximum pressure at the turbine inlet. The results are almost identical for the two simulations.



**Fig. 5** Comparison of the evolution of the turbine 1 rotational speed  $n$  and turbine 1 inlet piezometric head  $H$  obtained with two simulations: simulation with hydraulic model and simulation with the hydroelectric model.

### Earth fault

Here, the effect of an earth fault occurring between the generator and the transformer of group 1 is evaluated using both the electric and hydroelectric simulation models. Depending on the duration of the fault, the synchronization is maintained or lost after the fault is removed. The Fig. 6 presents a comparison of simulation results obtained using the two models, for a duration inferior and superior to the critical time  $t_c$ .  $t_c$  is underestimated by 2% using the electric model in which the turbine torque is assumed constant. The discrepancy between results is due to the action of the turbine power regulator.

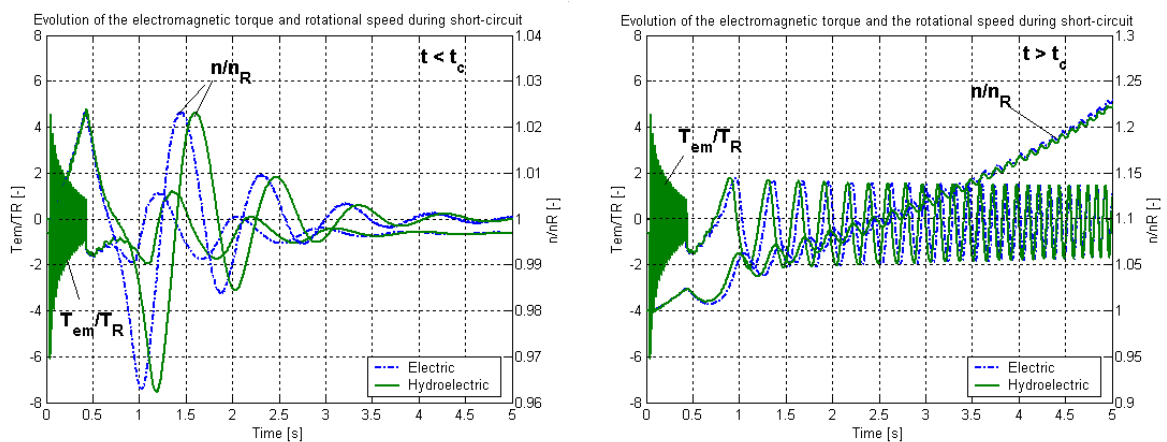

**Fig. 6** Comparison of the effect of an earth fault on group 1 with a duration under and over critical time  $t_c$  obtained with two simulations: simulation with electric model and simulation with the hydroelectric model.

### Out of phase synchronization

Three conditions are required for the success of the synchronization of the generator to the power network during the group start-up. The frequency, the phase and the magnitude have to match the corresponding network conditions before the closure of the circuit-breaker. The worst synchronization cases occurs when the the generator and the network are  $120^\circ$  and  $180^\circ$  degrees out of phase. Fig. 7, Fig. 8 and Fig. 9 present the effects of such wrong synchronization on the group 1. Fig. 8 presents the effect of group 1  $120^\circ$  out of phase situation on group 2.

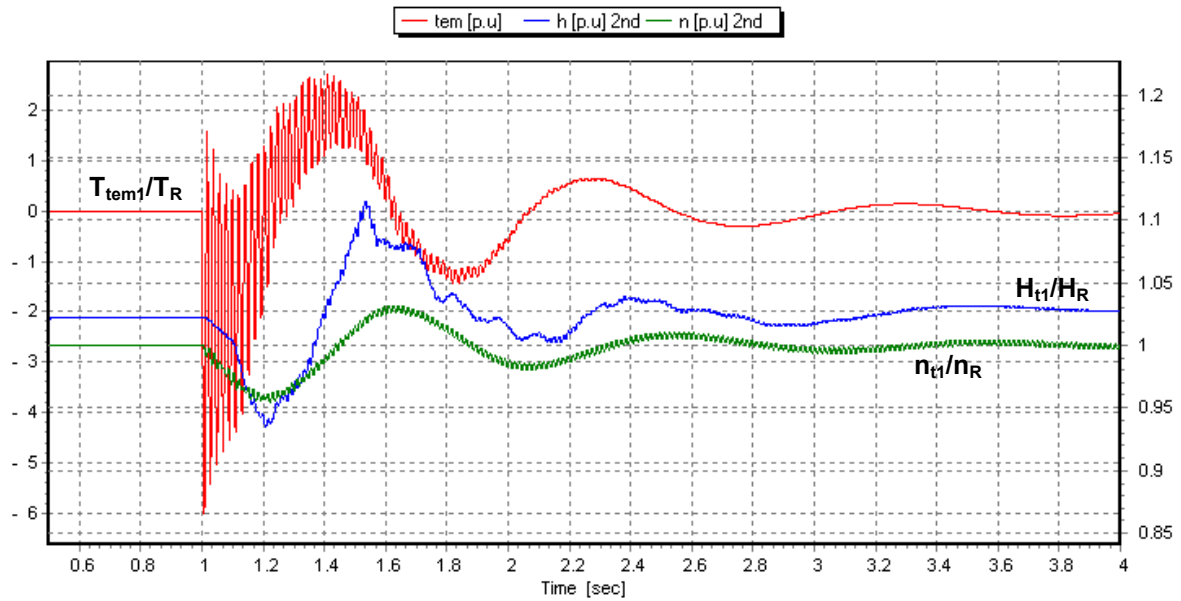

**Fig. 7** Evolution of the electromagnetic torque, the head of the turbine and rotational speed of the group number 1 during synchronization fault of 120° electrical degree.

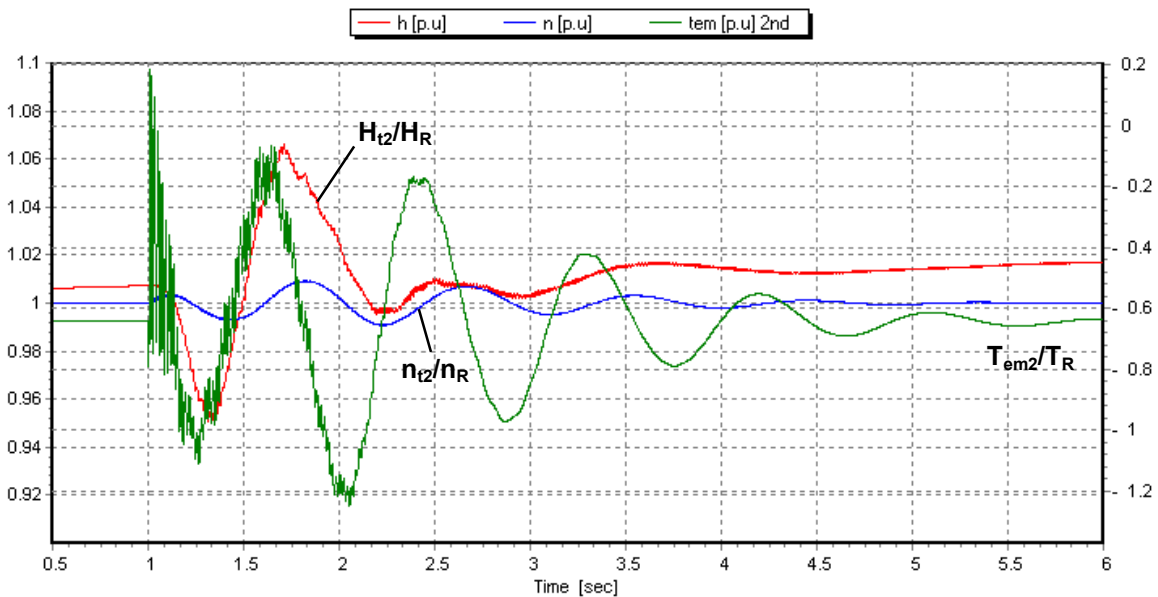

**Fig. 8** Effects of 120° out of phase fault of the group 1 on the group 2.

In the case of a 120° out of phase synchronization, the closure of the circuit-breaker induces a strong fluctuation of the electromagnetic torque that produces rotational speed variations. This results in the action of the speed regulator on the guide vane opening degree. Both effects contribute to turbine 1 inlet pressure variations. In addition, the first electromagnetic torque peak produces a free torsional vibrations at 63 Hz in the system constituted of turbine 1 inertia and stiffness of its connecting shaft. This dynamic response of the structure is observable on the turbine 1 pressure and evidences the coupling between hydraulic and mechanical parts. Group 2 is also affected by the fault on group 1: through the pressure and discharge fluctuations; and also by the current fluctuations in the electrical lines producing electromagnetic torque fluctuations.

The 180° out of phase synchronization produces stronger current variations that result in disturbances in the overall installation.

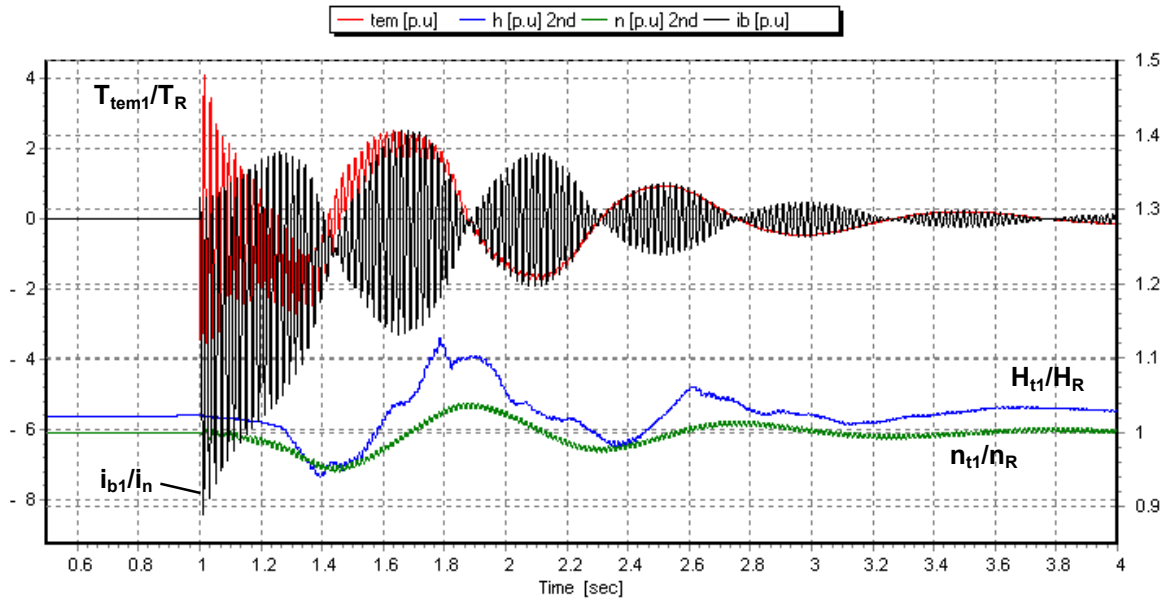

Fig. 9 Evolution of the electromagnetic torque, the head of the turbine and rotational speed of group 1 due to 180° out of phase synchronization.

### Load rejection and acceptance

Using the hydroelectric model, a load rejection and acceptance has been simulated taking into consideration the power regulator for the hydraulic part and the rotational speed regulator for the electrical part. The power consign first decreases from 73% down to 24% in 3 seconds and after 8 seconds increases up to 68% in 3 seconds. Fig. 10 presents the evolution of the variables of the installation during those variations. The hydroelectric model allows to optimize the control command in interconnected mode. Such an optimization is not possible when only one part of the model is taken into account. Using the hydroelectric model, it is also possible to assess the operating stability of the power plant taking into account the hydroelectric coupling effects.

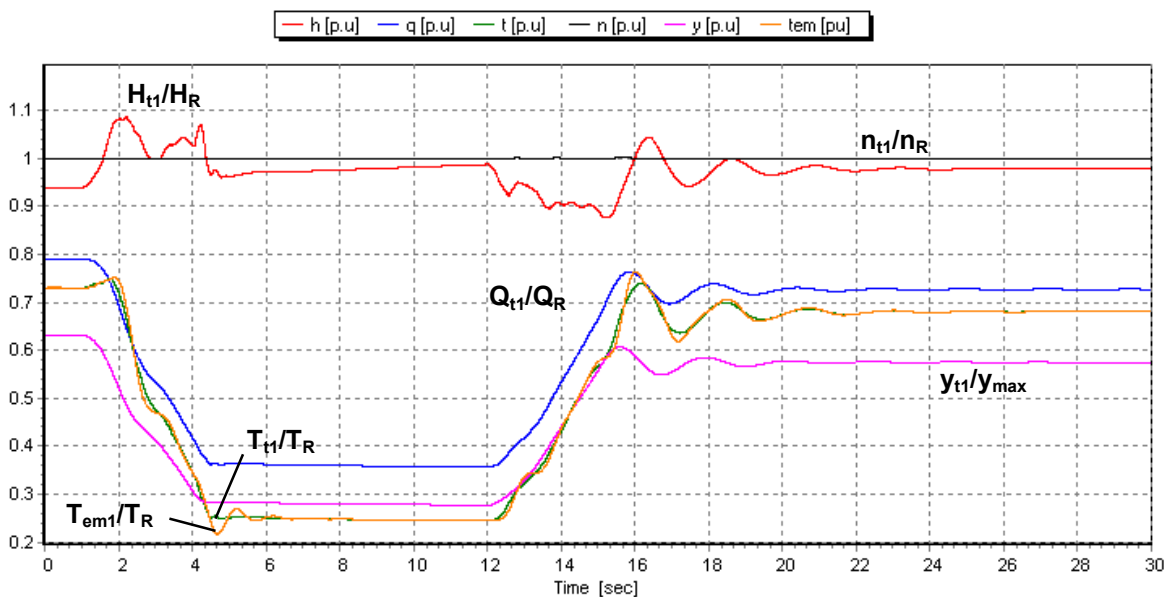

Fig. 10 Evolution of group 1 variables during a successive load rejection and acceptance.

## CONCLUSION

The transient behavior of a 2 Francis turbine power plant has been investigated using 3 models: hydraulic, electric and hydroelectric. Four disturbance cases have been simulated: total load rejection, earth fault, out of phase synchronization and load variation. A comparison of the simulations results using different models evidenced benefits of hydroelectric modeling.

The simulation of the three most critical transient phenomenon using decoupled models gave good agreements especially regarding prediction of the highest amplitudes of rotational speed, pressure, current and so on. This is mainly due to the difference of time scale of each part. In first approximation, for hydraulic transient behavior simulation, electrical phenomenon could be assumed to be instantaneous, while during electrical transient calculation the hydraulic variables could be taken constant.

However, simulation with hydroelectric model offers the 2 following advantages:

It enables to analyze in details the coupling between hydraulic, electric, mechanic and control parts. This is particularly convenient in the case of islanded and isolated production conditions where there is strong interactions between the electric and hydraulic parts.

In the field of control command, regulator parameter set requires an optimization. Control algorithm could be coded, and converted in *dll* format and then validated by simulation using SIMSEN. This allows testing new control strategies before their implementation in the control devices for interconnected production mode.

Finally, SIMSEN offers the advantage of allowing the development of electric and hydraulic models using the same tool. After determining a design ensuring safety with electric and hydraulic models on their own, these could be coupled for the stability assessment and the regulator parameters optimization.

## REFERENCES

- Ref. 1 FOX, J. A., 1989, "Transient flow in pipes, open channels and sewers". Ellis Horwood Limited, Chichester.
- Ref. 2 JAEGER, C., 1977, "Fluid transients in hydro-electric engineering practice ". Glasgow: Blackie.
- Ref. 3 IDEL'CIK, I. E., 1969, "Mémento des pertes de charge. Coefficients de perte de charge singulières et de pertes de charge par frottement ". Paris : Eyrolles.
- Ref. 4 MARCHAL, M., FLESH G. AND SUTER P., 1965, "The Calculation of Waterhammer problems by Means of the Digital Computer". Proc. Int. Symp. Waterhammer Pumped Storage Projects, ASME, Chicago.
- Ref. 5 NICOLET, C., AVELLAN, F., PRENAT, J. E., SAPIN, A., SIMOND, J. J., 2001, "A new tool for the simulation of dynamic behaviour of hydroelectric power plants ". 10th International meeting of the work group on the behaviour of hydraulic machinery under steady oscillatory conditions, Trondheim, Norway, June 26-28 2001.
- Ref. 6 NICOLET, C. , ALLENBACH, P. , SAPIN, A. , SIMOND, J.-J. , AVELLAN, F. ; 2002, "New Tools for the Simulation of Transient Phenomena in Francis Turbine Power Plants ".

Proceedings of the 21st IAHR Symposium on Hydraulic Machinery and Systems, Lausanne, Switzerland, 9-12 September 2002, pp. 519-528.

- Ref. 7 SAPIN, A., 1995, "Logiciel modulaire pour la simulation et l'étude des systèmes d'entraînement et des réseaux électriques". PhD thesis, EPFL, These n°1346.
- Ref. 8 SIMOND, J.-J., SAPIN A., ALLENBACH P., 2002, Simulation des réseaux et des systèmes d'entraînements électriques. Bulletin SEV/VSE 2002 Nr.7.
- Ref. 9 WYLIE, E. B. & STREETER, V.L., 1993, "Fluid transients in systems". Prentice Hall, Englewood Cliffs, N.J.

## AUTHORS

Christophe Nicolet, PhD student, is doing his PhD work on the subject of hydro-acoustic modeling of Francis turbine at the EPFL Laboratory for Hydraulic Machines in Lausanne, and is involved in the development of the SIMSEN hydraulic extension.

Francois Avellan, Prof., is director of the EPFL Laboratory for Hydraulic Machines in Lausanne, and is supervising the research and the collaboration with industry in field of hydraulic machines.

Philippe Allenbach, PE, is research assistant at the EPFL Electrical Machines Laboratory, and is in charge of the development of the software SIMSEN.

Alain Sapin, PhD, is power production manager at EEF in Fribourg and has developed the software SIMSEN in the framework of its PhD Thesis at the EPFL Electrical Machines Laboratory in Lausanne.

Jean-Jacques Simond, Prof. , is director of the EPFL Electrical Machines Laboratory in Lausanne, and is supervising the research and the collaboration with industry in field of electrical machines.

Sonia Kvicinsky, PhD, is principal scientist/engineer at Power Engineering in Costa Mesa, and is responsible of projects in the field of hydraulic machines.

Marcus Crahan, PE, is director of Power Engineering and has designed and supervised numerous turbine generator upgrade and diagnostic programs.